

APPENDIX D
LEVEL 1 AND LEVEL 2 REPORT:
DEVELOPMENT AND SCREENING OF POTENTIALLY EFFECTIVE AND
FEASIBLE ALTERNATIVES TO ACHIEVE THE BASIN PLAN OBJECTIVE
FOR WATER TEMPERATURE AND PROTECT COLD FRESHWATER
HABITAT BENEFICIAL USE ALONG THE NORTH FORK FEATHER RIVER
October 2007

Upper North Fork Feather River
Hydroelectric Project

Draft Environmental Impact Report

State Water Resources Control Board
Sacramento, CA

November 2014

LEVEL 1 AND 2 REPORT

DEVELOPMENT AND SCREENING OF POTENTIALLY EFFECTIVE AND FEASIBLE ALTERNATIVES
TO ACHIEVE THE BASIN PLAN OBJECTIVE FOR WATER TEMPERATURE
AND PROTECT COLD FRESHWATER HABITAT BENEFICIAL USE ALONG THE NORTH FORK FEATHER RIVER



W A T E R R E S O U R C E E N G I N E E R S

LEVEL 1 AND 2 REPORT

**DEVELOPMENT AND SCREENING OF POTENTIALLY EFFECTIVE AND FEASIBLE ALTERNATIVES
TO ACHIEVE THE BASIN PLAN OBJECTIVE FOR WATER TEMPERATURE AND
PROTECT COLD FRESHWATER HABITAT BENEFICIAL USE ALONG THE
NORTH FORK FEATHER RIVER**

Prepared For

State Water Resources Control Board

October 2007

Prepared By

Stetson Engineers, Inc.



EXECUTIVE SUMMARY	ES-1
ES.1 THREE-PHASED APPROACH.....	ES-1
ES.2 FRAMEWORK	ES-3
ES.3 FINAL LEVEL 2 WATER TEMPERATURE REDUCTION ALTERNATIVES.....	ES-4
1.0 INTRODUCTION	1-1
1.1 PURPOSE AND SCOPE.....	1-1
1.2 BACKGROUND	1-2
1.3 DESCRIPTION OF THE UNFFR PROJECT	1-4
1.4 OVERVIEW OF APPROACH TO THE DEVELOPMENT AND SCREENING OF POTENTIALLY FEASIBLE WATER TEMPERATURE REDUCTION ALTERNATIVES.....	1-6
1.5 OFF-SITE WATER TEMPERATURE MITIGATION	1-7
2.0 THE SUMMER THERMAL REGIME OF THE NORTH FORK FEATHER RIVER AND THE RESPONSE TO THE INFUSION OF COLD WATER.....	2-1
2.1 GENERAL DESCRIPTION OF THE SUMMER THERMAL REGIME	2-1
2.2 DETAILED DESCRIPTION OF THE SUMMER THERMAL REGIME BASED ON HISTORICAL MONITORING BY PG&E	2-2
<i>2.2.1 Summer Thermal Regime, 2002 – 2004.....</i>	<i>2-2</i>
<i>2.2.2 Severe Summer Thermal Regime, July 2002.....</i>	<i>2-2</i>
<i>2.2.3 Reservoir Water Temperature Profiles.....</i>	<i>2-4</i>
2.3 THERMAL RESPONSE TO THE INFUSION OF COLD WATER	2-5
<i>2.3.1 July 2003 Caribou PH Special Test.....</i>	<i>2-5</i>
<i>2.3.2 Summer 2006 Special Test.....</i>	<i>2-7</i>
3.0 FRAMEWORK FOR DEVELOPING AND SCREENING WATER TEMPERATURE REDUCTION ALTERNATIVES.....	3-1
3.1 FRAMEWORK	3-2
3.2 WATER TEMPERATURE REDUCTION ALTERNATIVE CATEGORIES	3-5
4.0 LEVEL 1 WATER TEMPERATURE REDUCTION ALTERNATIVES FORMULATION AND SCREENING	4-1
4.1 FORMULATION OF INITIAL LEVEL 1 WATER TEMPERATURE REDUCTION ALTERNATIVES	4-1
<i>4.1.1 Water Temperature Reduction Alternative Category 1: Reduce the temperature in Belden Forebay to 12.5°C.....</i>	<i>4-2</i>
<i>4.1.2 Water Temperature Reduction Alternative Category 2: Reduce the temperature in Belden Forebay to 14.5°C combined with additional temperature reduction along the Poe Reach</i>	<i>4-2</i>

4.1.3	<i>Water Temperature Reduction Alternative Category 3: Reduce the temperature in Belden Forebay to 16.0°C combined with additional temperature reduction measures along the lower Belden, Cresta, and Poe Reaches.</i>	<i>4-4</i>
4.1.4	<i>Water Temperature Reduction Alternative Category 4: Reduce the temperature in Belden Forebay to 18.0°C combined with additional temperature reduction measures along the lower Belden, Rock Creek, Cresta, and Poe Reaches.....</i>	<i>4-5</i>
4.1.5	<i>Water Temperature Reduction Alternative Category 5: Reduce the temperature in Belden Forebay to 19.5°C combined with additional temperature reduction measures along all downstream reaches</i>	<i>4-9</i>
4.1.6	<i>Water Temperature Reduction Alternative Category 6: Reduce temperatures in all downstream reaches</i>	<i>4-12</i>
4.2	SCREENING OF INITIAL LEVEL 1 WATER TEMPERATURE REDUCTION ALTERNATIVES AND FINAL LEVEL 1 WATER TEMPERATURE REDUCTION ALTERNATIVES	4-17
5.0	LEVEL 2 ANALYSIS OF WATER TEMPERATURE REDUCTION ALTERNATIVES.....	5-1
5.1	INITIAL LEVEL 2 WATER TEMPERATURE REDUCTION ALTERNATIVES -- DESIGN LAYOUTS, OPERATIONAL REQUIREMENTS, COST ESTIMATES, AND EFFECTIVENESS	5-1
5.2	SCREENING OF INITIAL LEVEL 2 WATER TEMPERATURE REDUCTION ALTERNATIVES AND FINAL LEVEL 2 WATER TEMPERATURE REDUCTION ALTERNATIVES	5-14
6.0	PROPOSED APPROACH FOR LEVEL 3 ANALYSIS OF WATER TEMPERATURE REDUCTION ALTERNATIVES.....	6-1
	REFERENCES.....	R-1

APPENDICES

A	SUMMARY OF OBSERVED SUMMER 2002 – 2004 MEAN DAILY WATER TEMPERATURES AND FLOWS ALONG THE NFFR
B	SUMMARY OF SUMMER 2002 - 2004 MEAN DAILY WATER TEMPERATURE COMPARISON WITH THE 20°C LEVEL
C	EVALUATION OF POTENTIAL MEASURES FOR REDUCING WATER TEMPERATURE IN THE NORTH FORK FEATHER RIVER
D	COUNTY OF PLUMAS WATERSHED RESTORATION AND IMPROVEMENT ALTERNATIVE
E	ROUGH ENGINEERING DESIGNS AND COST ESTIMATES FOR WATER TEMPERATURE REDUCTION MEASURES

LIST OF TABLES**PAGE**

Table ES-1	Summary of Alternative Categories and Requirements	ES-7
Table ES-2	Final Level 2 Alternatives to Achieve the 20°C Objective Target for Water Temperature along the NFFR	ES-8
Table 2-1	Physical Characteristics of Reservoirs along the NFFR	2-12
Table 2-2a	Summary of 2002 - 2004 Mean Daily Water Temperatures along the NFFR Reaches (°C)	2-14
Table 2-2b	Summary of 2002 - 2004 Mean Daily Water Temperatures at the NFFR Powerhouse Discharges	2-16
Table 2-3a	Summary of 2002 - 2004 Mean Daily Water Temperature Comparison with the 20°C Level along the NFFR Reaches	2-17
Table 2-3b	Summary of 2002 - 2004 Mean Daily Water Temperature Comparison with the 20°C Level at the NFFR Powerhouse Discharges	2-19
Table 2-4	Summary of Observed Mean Daily Water Temperatures during July 2003 Caribou Special Test.....	2-20
Table 3-1	Meteorology Data in July 2002.....	3-7
Table 3-2	SNTEMP Model Verification Results Using July 2002 Data.....	3-7
Table 3-3	Summary of Alternative Categories and Requirements.....	3-8
Table 4-1	Initial Level 1 Alternatives to Achieve the 20°C Objective Target for Water Temperature along the NFFR	4-14
Table 4-2	Final Level 1 Alternatives to Achieve the 20°C Objective Target for Water Temperature along the NFFR	4-19
Table 5-1	Initial Level 2 Alternatives to Achieve the 20°C Objective Target for Water Temperature along the NFFR	5-3
Table 5-2a	Summary of Cost Estimates for Alternative Category 2.....	5-6
Table 5-2b	Summary of Cost Estimates for Alternative Category 3.....	5-7
Table 5-2c	Summary of Cost Estimates for Alternative Category 4.....	5-8
Table 5-2d	Summary of Cost Estimates for Alternative Category 5.....	5-10
Table 5-2e	Summary of Cost Estimates for Alternative Category 6.....	5-12
Table 5-3a	Screening of Alternative/ Measures under Alternative Category 2	5-16
Table 5-3b	Screening of Alternative/ Measures under Alternative Category 3	5-17
Table 5-3c	Screening of Alternative/ Measures under Alternative Category 4	5-18
Table 5-3d	Screening of Alternative/ Measures under Alternative Category 5	5-21
Table 5-3e	Screening of Alternative/ Measures under Alternative Category 6	5-24
Table 5-4	Final Level 2 Alternatives to Achieve the 20°C Objective Target for Water Temperature along the NFFR	5-26
Table 6-1	Proposed NFFR Water Temperature Models for Level 3 Analysis	6-6

LIST OF FIGURES**PAGE**

Figure ES-1	Alternatives Development and Evaluation Process Flow Diagram and Resulting Number of Alternatives in Level 1 and 2.....	ES-6
Figure 1-1a	Upper North Feather River Project, Generalized Land Use - North.....	1-9
Figure 1-1b	Upper North Feather River Project, Generalized Land Use - South.....	1-10
Figure 1-2	Alternatives Development and Evaluation Process Flow Diagram.....	1-11
Figure 2-1	NFFR Stream Temperature Monitoring Locations.....	2-13
Figure 2-2	Observed and Estimated July 2002 (Dry Year) Water Temperature Profile along NFFR.....	2-22
Figure 2-3a	Belden Reservoir Temperature Profiles, June 21, 1985.....	2-23
Figure 2-3b	Belden Reservoir Temperature Profiles.....	2-24
Figure 2-3c	Belden Reservoir Temperature Profiles.....	2-25
Figure 2-4	Rock Creek Reservoir Temperature Profiles near Rock Creek Dam, 1985.....	2-26
Figure 2-5	Cresta Reservoir Temperature Profiles near Cresta Dam, 1985.....	2-27
Figure 2-6	Poe Reservoir Temperature Profiles near Poe Dam, 1985.....	2-28
Figure 2-7	Hourly Inflows to Belden Reservoir on 7/21 - 7/ 31, 2002.....	2-29
Figure 2-8	Hourly Inflows to Rock Creek Reservoir on 7/21 - 7/ 31, 2002.....	2-30
Figure 2-9	Observed Mean Daily Temperatures along NFFR during July 2003 Caribou Special Test.....	2-31
Figure 2-10	Observed Mean Daily Temperatures Indicating Possible Belden Reservoir Stratification during July 2003 Caribou Special Test.....	2-32
Figure 2-11	Observed Mean Daily Temperatures Indicating Possible Rock Creek Reservoir Warming during July 2003 Caribou Special Test.....	2-33
Figure 2-12	Belden Reservoir Water Temperature Profile Monitoring Sites and Current Velocity Transects during Summer 2006 Special Test.....	2-34
Figure 2-13	Belden Reservoir Temperature Profiles along the Centerline of the Upper Portion of the Reservoir during Summer 2006 Special Test (Caribou #2 was shutdown; Caribou #1 was operating at 527 cfs).....	2-35
Figure 2-14	Observed Mean Daily Water Temperatures at Various Strata of Belden Reservoir near Dam (BDR2) during Summer 2006 Special Test.....	2-36
Figure 2-15	Observed Temperature Profiles of Rock Creek Reservoir near Dam during Summer 2006 Special Test.....	2-37
Figure 2-16	Observed Butt Valley PH Mean Daily Discharges and Discharge Water Temperatures during Summer 2006 Special Test.....	2-38
Figure 2-17	Butt Valley Reservoir Temperature Profile Monitoring Sites and Current Velocity Transects during Summer 2006 Special Test.....	2-39
Figure 2-18	Observed Water Temperature Profiles along the Upper Portion of Butt Valley Reservoir August 3, 2006.....	2-40
Figure 3-1	Hydrology and Temperature Data Used as Inputs in the SNTEMP Modeling Analysis.....	3-9

LIST OF FIGURES (CONTINUED)**PAGE**

Figure 3-2a	Estimated July 2002 (Dry Year) Water Temperature Profile along NFFR	3-10
Figure 3-2b	Estimated July 2002 (Dry Year) Water Temperature Profile along NFFR	3-11
Figure 3-2c	Estimated July 2002 (Dry Year) Water Temperature Profile along NFFR	3-12
Figure 3-2d	Estimated July 2002 (Dry Year) Water Temperature Profile along NFFR	3-13
Figure 3-2e	Estimated July 2002 (Dry Year) Water Temperature Profile along NFFR	3-14
Figure 3-2f	Estimated July 2002 (Dry Year) Water Temperature Profile along NFFR	3-15
Figure 3-2g	Estimated July 2002 (Dry Year) Water Temperature Profile along NFFR	3-16
Figure 3-3	Estimated July 2002 (Dry Year) Water Temperature Profiles along NFFR for a Range of Inflow Temperatures at Belden Forebay	3-17
Figure 3-4a	July 2002 (Dry Year) Water Temperature Profile along NFFR Required to Achieve Target	3-18
Figure 3-4b	July 2002 (Dry Year) Water Temperature Profile along NFFR Required to Achieve Target with Sacrifice of Lower Belden Reach below East Branch NFFR Confluence	3-19
Figure 4-1	Alternatives Development and Evaluation Process Flow Diagram and Resulting Number of Alternatives in Level 1	4-22
Figure 5-1	Illustrative Layout of Packaged Measures for Alternative 2C	5-29
Figure 5-2	Illustrative Layout of Packaged Measures for Alternative 3	5-30
Figure 5-3	Illustrative Layout of Packaged Measures for Alternative 4A	5-31
Figure 5-4	Illustrative Layout of Packaged Measures for Alternative 4B	5-32
Figure 5-5	Illustrative Layout of Packaged Measures for Alternative 4C	5-33
Figure 5-6	Illustrative Layout of Packaged Measures for Alternative 5A	5-34
Figure 5-7	Illustrative Layout of Packaged Measures for Alternative 5B	5-35
Figure 5-8	Alternatives Development and Evaluation Process Flow Diagram and Resulting Number of Alternatives in Level 1 and 2	5-36
Figure 6-1	Proposed Water Temperature Models and Model Relationships	6-7

LIST OF ABBREVIATIONS/ACRONYMS

af	Acre-foot or acre-feet
afa	Acre-feet per annum
Basin Plan	Water Quality Control Plan for the Central Valley Region
BSP	Black steel pipe
CDFG	California Department of Fish and Game
Central Valley Regional Board	Regional Water Quality Control Board, Central Valley Region
CEQA	California Environmental Quality Act
cfs	Cubic feet per second
CWA	Federal Clean Water Act
cy	Cubic yard
DSOD	Division of Safety of Dams
DWR	California Department of Water Resources
East Branch	East Branch North Fork Feather River
EIR	Environmental Impact Report
EIS	Environmental Impact Statement
FERC	Federal Energy Regulatory Commission
FERC No. 2105	Upper North Fork Feather River Project
FERC No. 1962	Rock Creek – Cresta Project
FERC No. 619	Bucks Creek Project
FERC No. 2107	Poe Project
fps	Feet per second
ft	Feet or Foot
HDPE	High-density polyethylene
IIHR	Iowa Institute of Hydraulic Research
KWh	Kilowatt-hour
LF	Linear feet
Licensing Group	Upper North Fork Feather River Project Collaborative Licensing Group
MW	Megawatts
NEPA	National Environmental Policy Act
NFFR	North Fork Feather River
NGVD 1929	National Geodetic Vertical Datum of 1929
No.	Number
NOP	Notice of Preparation
NSR	North State Resources, Inc.
O&M	Operation and Maintenance
Partial Settlement	Upper North Fork Feather River Project Relicensing Settlement Agreement, 2004

LIST OF ABBREVIATIONS/ACRONYMS (CONTINUED)

PG&E	Pacific Gas and Electric Company
PH	Powerhouse
PM&E	Protection, mitigation, and enhancement
RCB	Reinforced concrete box
RCP	Reinforced concrete pipe
sq ft	Square feet
State Water Board	State Water Resources Control Board
Stetson	Stetson Engineers, Inc.
SNTEMP	Stream Network Temperature Model
UNFFR	Upper North Fork Feather River
U.S. EPA	U.S. Environmental Protection Agency
USFWS	U.S. Fish and Wildlife Service
USFS	U.S. Forest Service
USGS	U.S. Geological Survey
x-section	Cross-section
°C	Degrees Celsius
°F	Degrees Fahrenheit
#	Number

LEVEL 1 AND 2 REPORT

DEVELOPMENT AND SCREENING OF POTENTIALLY EFFECTIVE AND FEASIBLE ALTERNATIVES TO ACHIEVE THE BASIN PLAN OBJECTIVE FOR WATER TEMPERATURE AND PROTECT COLD FRESHWATER HABITAT BENEFICIAL USE ALONG THE NORTH FORK FEATHER RIVER

EXECUTIVE SUMMARY

Pacific Gas and Electric Company (PG&E) has submitted an application to the Federal Energy Regulatory Commission for relicensing of the Upper North Fork Feather River Project (FERC Project #2105). Prior to issuance of a new federal license, PG&E must obtain Clean Water Act (CWA) section 401 water quality certification that the project will be in compliance with specified provisions of the CWA (33 U.S.C. § 1341), including State water quality standards as contained in the applicable water quality control plan. Portions of the North Fork Feather River (NFFR) do not meet the water quality objective for temperature as set forth in the Water Quality Control Plan for the Central Valley Region (Basin Plan). The State Water Resources Control Board has determined that elevated water temperatures are impairing the cold freshwater habitat beneficial use of the NFFR, and has cited hydromodification and flow regulation as potential sources of the impairment (State Water Board Resolution No. 2006-0079). Water quality certification of the project is subject to the California Environmental Quality Act (CEQA), and an Environmental Impact Report (EIR) with CEQA alternatives that include water temperature reduction proposals will be prepared to meet this requirement.

Consistent with requirements of CEQA, alternatives to be evaluated in the EIR should be reasonable, feasible and implementable. This Level 1 and 2 Report documents initial progress on the development and screening of a wide range of potentially feasible alternatives for seasonal cooling of water temperature along the NFFR. Each of the “water temperature reduction alternatives” considered consists of a combination of measures, such as modifications to hydropower facilities or operations, which collectively reduce mean daily water temperatures during the summer to 20°C along the approximate 50 river miles of the NFFR, from Lake Almanor’s Canyon Dam to the discharge from the Poe Powerhouse afterbay at Big Bend into Lake Oroville.

ES.1 THREE-PHASED APPROACH

CEQA guidelines require that the State Water Board base its findings concerning alternatives and project approval on “substantial evidence.” With this in mind, a systematic, three-phased approach to the development and screening of water temperature reduction measures has been developed. The three-phased approach provides transparency and a logical elimination of those less effective or less reasonable measures, allowing the more realistic solutions to remain as potential comprehensive watershed alternatives. This Level 1 and 2 Report documents the first two phases of the three-phased approach used to develop a reasonable range of feasible water temperature reduction alternatives for achieving the water temperature objective and protection of the cold freshwater habitat beneficial use of the NFFR. A subsequent report will document the refined Level 3 analysis and final screening of water temperature alternatives suitable for

analysis in the EIR prepared for the CEQA process. Figure ES-1 illustrates the three-phased approach as a flow diagram and presents the results of Level 1 and Level 2 screening.

To facilitate the development and analysis of water temperature reduction alternatives that could address the temperature objectives established by the Basin Plan, a numerical value for the water temperature objective was deemed necessary (water temperature objective target or “temperature target”). In setting the temperature target value, it was recognized that it must be feasibly attainable through physical or operational modifications of the UNFFR Project, since the alternatives being developed are intended for support of the State Water Board’s 401 certification decision for relicensing of the FERC No. 2105 Project. Accordingly, for purposes of developing and screening water temperature reduction alternatives in this Level 1 and 2 Report, *a numerical value of 20°C maximum mean daily NFFR-wide was set as the water temperature objective target.*^{1,2} This initial numerical value could be modified in the subsequent Level 3 effort if, at that time, a different and more appropriate temperature target is determined to be feasibly attainable through modification or re-operation of the UNFFR Project.

Level 1 casts a “wide net” that captures most all of the possible water temperature reduction alternatives and then subjects these possible alternatives to the following coarse screening criteria:

- Effectiveness and reliability – Is there a reasonable potential that the alternative can effectively and reliably achieve the preliminary temperature target or, is the effectiveness and reliability of the alternative overly speculative?
- Technological feasibility and constructability – Can the alternative be implemented with currently available technology and construction methods?
- Logistics – Can the alternative be implemented when considering current legal obligations, regulatory permitting requirements, public safety needs, right-of-way and access needs, and other real world logistical constraints?
- Reasonability³ – Are there clearly more reasonable or superior alternatives available based on the other criteria? Is implementation of the alternative remote or highly speculative?

The set of alternative measures passing Level 1 screening represents a reasonable range of potentially effective and feasible water temperature reduction alternative measures that are carried forward to Level 2.

Level 2 screens-out (eliminates) those water temperature reduction alternatives passing Level 1 screening that, after closer examination, are ineffective, infeasible, or are clearly inferior to other alternatives. In Level 2 the alternatives are analyzed using the best resource information currently available. Water temperature reduction alternatives are modified or refined based on

¹ This water temperature objective target was set only for purposes of developing and screening alternatives, and should not be construed as the numeric temperature requirement necessary to achieve compliance with the Basin Plan. The State Water Board will determine the appropriate numeric temperature requirement in its 401 certification decision.

² The basis for this temperature target is explained in Chapter 3.

³ An EIR need not consider an alternative whose effect cannot be reasonably ascertained and whose implementation is remote and speculative (CEQA Guidelines, § 15126, subd. (d)).

the analysis, and rough engineering designs and cost estimates are developed. The alternatives are subjected to the same screening criteria used in Level 1, plus the following additional criteria:

- Substantial Further Study - Is there sufficient information currently available or can it be readily developed in order to evaluate the potential effectiveness and feasibility of the alternative, or is substantial further investigation or study required?
- Environmental challenges – Are there obvious environmental consequences or problems associated with the alternative that would pose a major challenge to overcome?
- Economic feasibility – Can the alternative be implemented at a reasonable cost, including capital, O&M, and considering energy replacement costs?

The resulting Level 2 alternatives represent *the set of potentially effective and feasible water temperature reduction alternatives* that are advanced to Level 3. A separate report will be prepared to document the Level 3 water temperature reduction alternatives analysis and screening efforts.

Prior to completing the Level 3 analysis and screening, additional detailed modeling, engineering design, and cost estimate work will be completed. This work will involve application of new water quality models and the newly modified existing hydrologic and temperature models in a detailed technical analysis. During Level 3 screening, these data and models will be used to carefully analyze the effectiveness, sustainability, and reliability of the water temperature reduction alternatives that advanced from Level 2. The temperature reduction alternatives may be further modified or refined based on the analysis, particularly if a new water temperature target is developed. The water temperature reduction alternatives verified to be effective, sustainable, and reliable will be designed to a feasibility-level of detail. The alternatives will then be screened based on the same screening criteria used in Level 1 and 2. The resulting set of water temperature reduction alternatives passing the Level 3 screening will represent *the set of effective and feasible water temperature reduction alternatives*. These water temperature reduction alternatives will be carried forward into the EIR as elements of the CEQA alternatives, where they may be augmented and/or modified to address potentially significant environmental impacts identified through the CEQA process.

ES.2 FRAMEWORK

The complexity of the NFFR system hydrology and thermal regime and the large number of potential water temperature reduction measures under consideration (41 measures) demands that a systematic approach be followed to develop and screen potential water temperature reduction alternatives⁴. Recognizing this need, a “framework concept” was formulated that approaches the problem of reducing water temperatures along the entire NFFR by developing solutions on a reach-by-reach scale. Solutions identified in each reach become available as interchangeable

⁴ Refer to Appendix C for presentation of potential water temperature reduction measures. These potential water temperature reduction measures were derived from those described in PG&E’s 24 Alternatives Report (PG&E, 2005b) as well as others developed by the State Water Board team. These measures mainly consist of physical and operational changes to existing UNFFR Project facilities, but changes to other PG&E-owned and non-PG&E-owned facilities in the NFFR basin are considered as well. Watershed management actions that may potentially reduce temperature are also included.

measures that can be combined as necessary to create a comprehensive water temperature reduction alternative for the NFFR. The framework provides alternatives that focus on reducing the temperature of water delivered to and discharged from Belden Reservoir, then builds from this point by adding measures as necessary to satisfy the temperature needs in all reaches of the NFFR. Water temperature reduction at Belden Reservoir is central to achieving temperature reduction in the downstream reaches and, the cooler the water available for discharge from Belden Reservoir, the less the water needs to be cooled downstream to meet the target. Use of the framework concept allows for the formulation, analysis, and evaluation of a full range of alternative ways to reduce the temperature of water in Belden Reservoir and combines additional cooling along individual or multiple downstream reaches, as necessary for comprehensive watershed solutions.

Because the temperature of water discharged from Belden Reservoir drives the amount of cooling required in the downstream reaches, an analysis was performed to determine, over a range of starting water temperatures in Belden Reservoir, the additional cooling that would be needed to achieve the temperature target in all downstream reaches. The month of July 2002 was used as the analysis period⁵ in the framework to estimate NFFR water temperature profiles for a range of starting water temperatures in Belden Reservoir. The profiles were estimated based on July 2002 meteorological conditions, observed temperature changes in the Belden and Rock Creek Reservoirs during the July 2003 Caribou special test for the infusion of cold water, and use of stream temperature modeling of the Belden, Rock Creek, Cresta, and Poe Reaches. Results of the modeling work formed the basis for the formulation of six categories of water temperature reduction alternatives as shown in Table ES.1. The categories are differentiated by the amount of temperature reduction provided at Belden Reservoir. A higher numbered category means that more temperature reduction is required in reaches downstream.

ES.3 FINAL LEVEL 2 WATER TEMPERATURE REDUCTION ALTERNATIVES

Through the Level 1 and Level 2 water temperature reduction alternatives development and screening process, the set of comprehensive, potentially feasible water temperature reduction alternatives was generated. The set of potentially feasible water temperature reduction alternatives, including variations of the alternatives, are summarized in Table ES-2. The following 16 alternatives and alternative variations remain and will advance to Level 3 for further refinement, analysis, and screening.

- **Alternative Category 2** – one alternative (Alternative 2c) with one variation for the Poe Reach. No water temperature reduction measures are needed for the Belden, Rock Creek, and Cresta Reaches. This Category has *one alternative variation* (i.e., $1 \times 1 = 1$).
- **Alternative Category 3** – one alternative (Alternative 3) with one variation for each of the Belden, Cresta, and Poe Reaches. No water temperature reduction measures are needed for the Rock Creek Reach. This Category has *one alternative variation* (i.e., $1 \times 1 \times 1 = 1$).

⁵ Data from July 2002 represents the most adverse conditions for achieving the temperature target, as compared to all months during PG&E's summer 2002 – 2004 monitoring period. Any water temperature reduction alternative that could achieve the target during July 2002 could likely do so during the summer months of any wet, normal, and most dry years. The thermal regime of the NFFR during PG&E's summer 2002 – 2004 monitoring period and, in particular, during July 2002 is explained in Chapter 2.

- **Alternative Category 4** – three alternatives (Alternatives 4a, 4b, and 4c) with one variation for the Belden Reach, one variation for the Rock Creek Reach, two variations for the Cresta Reach, and one variation for the Poe Reach, totaling *6 alternative variations* (i.e., $3 \times 1 \times 1 \times 2 \times 1 = 6$).
- **Alternative Category 5** – two alternatives (Alternatives 5a and 5b) with one variation for the Belden Reach, one variation for the Rock Creek Reach, two variations for the Cresta Reach, and two variations for the Poe Reach, totaling *8 alternative variations* (i.e., $2 \times 1 \times 1 \times 2 \times 2 = 8$).

These water temperature reduction alternatives were developed using the best available data and analytical tools generated through years of effort, including:

- PG&E's temperature modeling results for 33-years of the hydrologic record (Bechtel Corporation and Thomas R. Payne and Associates 2006);
- PG&E's physical-prototype hydraulic modeling results for the Prattville Intake thermal curtain (IIHR 2004);
- PG&E's 2002-2004 temperature monitoring data reports (PG&E 2003; PG&E 2004; PG&E 2005a);
- PG&E's 2006 NFFR special testing data (Stetson and PG&E 2007); and
- Stream water temperature modeling analysis and water temperature mixing analysis (refer to Chapter 3).

Particularly noteworthy is PG&E's 2006 NFFR special test which demonstrated cold water plunging and stratification in Butt Valley and Belden Reservoirs, suggesting that new measures for cooling may be effective, sustainable, and reliable, including:

- Reduced rate of withdrawal from the Prattville Intake for thermal selection;
- Re-operation of the Caribou Powerhouses through preferential or exclusive use of Caribou Powerhouse No. 1 or strict extended peaking procedures; and
- Enhanced submerged flow of cool water along the bottom of Butt Valley and Belden Reservoirs.

Further analysis is proposed in future Level 3 to verify the effectiveness, sustainability, reliability, and feasibility of the water temperature reduction alternatives to be carried forward from Level 2. New water quality models of Butt Valley Reservoir and Belden Reservoir have been developed and existing models of Lake Almanor have been improved. These models will enable engineers to simulate water temperatures in the lakes, reservoirs and flowing reaches of the NFFR and test the effectiveness, sustainability, and long-term reliability of the alternatives at reducing water temperatures. More detailed engineering design and cost estimating work will examine the feasibility and costs associated with the alternatives, including initial capital cost, recurring annual cost, and foregone power cost. All of this further work will be documented in the Level 3 report, which will set forth the water temperature alternatives to be carried forward into the EIR for broader environmental analysis.

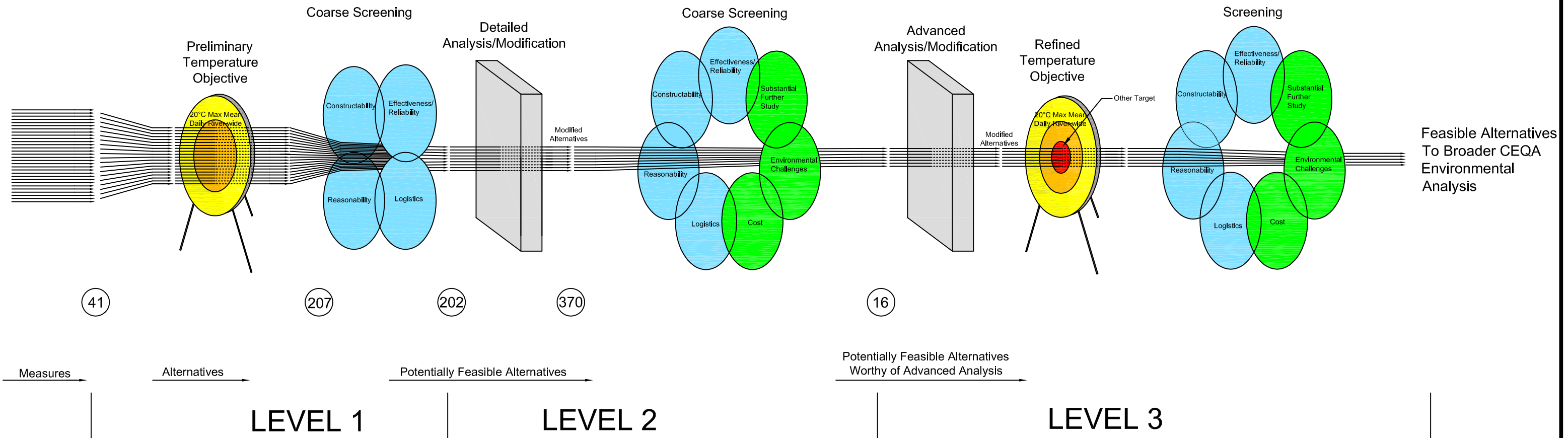


Figure ES-1

Upper North Fork Feather River: Alternatives Development and Evaluation Process Flow Diagram and Resulting Number of Alternatives in Level 1 & 2

Table ES-1 Summary of Alternative Categories and Requirements

Alternative Category		Belden Reach	Rock Creek Reach	Cresta Reach	Poe Reach
1	Cold Water from Lake Almanor/Butt Valley Reservoir	Reduce inflow temperature at Belden Forebay to 12.5°C			
	Additional Cold Water Needed?	No	No	No	No
2	Cold Water from Lake Almanor/Butt Valley Reservoir	Reduce inflow temperature at Belden Forebay to 14.5°C			
	Additional Cold Water Needed?	No	No	No	Yes
3	Cold Water from Lake Almanor/Butt Valley Reservoir	Reduce inflow temperature at Belden Forebay to 16.0°C			
	Additional Cold Water Needed?	No (except for lower Belden reach)	No	Yes	Yes
4	Cold Water from Lake Almanor/Butt Valley Reservoir	Reduce inflow temperature at Belden Forebay to 18.0°C			
	Additional Cold Water Needed?	No (except for lower Belden reach)	Yes	Yes	Yes
5	Cold Water from Lake Almanor/Butt Valley Reservoir	Reduce inflow temperature at Belden Forebay to 19.5°C			
	Additional Cold Water Needed?	Yes	Yes	Yes	Yes
6	Cold Water from Lake Almanor/Butt Valley Reservoir	No			
	Additional Cold Water Needed?	Yes	Yes	Yes	Yes

Table ES-2 Final Level 2 Alternatives to Achieve the 20 °C Objective Target for Water Temperature along the NFFR

(Green highlighted measures remain as final Level 2 Alternatives and will advance to Level 3; Bright green highlighted measures represent variations for cooling downstream reaches)

Alternative Category	Alternative		Variations for Cooling Downstream Reaches			
	Alt.	Measures in reducing source water temperature to Belden Forebay	Additional measures for Belden Reach	Additional measures for Rock Creek Reach	Additional measures for Cresta Reach	Additional measures for Poe Reach
1. Reduce the temperature in Belden Forebay to 12.5 °C. (eliminated)	1	<ul style="list-style-type: none"> Install Prattville thermal curtain with levee removed Collect and convey cold spring water (215 cfs, 8°C) to Prattville Intake Convey Butt Valley PH discharges to Butt Valley Reservoir near Caribou Intake 	No	No	No	No
2. Reduce the temperature in Belden Forebay to 14.5 °C. (1 variation)	2a	<ul style="list-style-type: none"> Install Prattville thermal curtain with levee removed Convey Butt Valley PH discharges to 2,000 cfs to Butt Valley Reservoir near Caribou Intake 	No	No	No	<ul style="list-style-type: none"> Increase shading along Poe Reach
	2b	<ul style="list-style-type: none"> Install Prattville thermal curtain with levee removed Install a thermal curtain near Caribou Intake in Butt Valley Reservoir Collect and convey cold spring water (215 cfs, 8°C) to Prattville Intake 				<ul style="list-style-type: none"> Increase Poe Dam release to 360 cfs
	2c	<ul style="list-style-type: none"> Decrease Prattville Intake release to 500 cfs to cause cold water selective withdrawal Extend the existing deeper channel of Butt Valley Reservoir by dredging Use Caribou #1 exclusively with reduced release to cause cold water selective withdrawal from Butt Valley Reservoir Repair/modify Canyon Dam low level outlet and increase release to 600 cfs 				<ul style="list-style-type: none"> Construct outlet/pipeline from the Poe Adit and release to 180 cfs of cooler water to the Poe Reach
3. Reduce the temperature in Belden Forebay to 16.0 °C. (1 variation)	3	<ul style="list-style-type: none"> Install Prattville thermal curtain with levee removed Install a thermal curtain near Caribou Intake in Butt Valley Reservoir Increase Canyon Dam release to 250 cfs (and decrease Prattville Intake release commensurately) 	<ul style="list-style-type: none"> Convey warm water to 100 cfs from East Branch NFFR to Rock Creek Reservoir by diversion/pipeline <p>Note: This measure is designed to protect the lower Belden Reach</p>	No	<ul style="list-style-type: none"> Increase Cresta Dam release to 390 cfs 	<ul style="list-style-type: none"> Increase Poe Dam release to 300 cfs Construct outlet/pipeline from the Poe Adit and release to 400 cfs the cooler water to the Poe Reach
					<ul style="list-style-type: none"> Increase Grizzly Creek release to 50 cfs 	

Note: All alternatives will have no affect on Lake Almanor water levels except Alternative 2c which would result in higher than historical lake levels due to significant flow reduction at the Prattville Intake.

**Table ES-2 Final Level 2 Alternatives to Achieve the 20°C Objective Target for Water Temperature along the NFFR
(Continued)**

Alternative Category	Alternative		Variations for Cooling Downstream Reaches			
	Alt.	Measures in reducing source water temperature to Belden Forebay	Additional measures for Belden Reach	Additional measures for Rock Creek Reach	Additional measures for Cresta Reach	Additional measures for Poe Reach
4. Reduce the temperature in Belden Forebay to 18.0 °C. (6 variations)	4a	<ul style="list-style-type: none"> Install Prattville thermal curtain Install a thermal curtain near Caribou Intake in Butt Valley Reservoir 	<ul style="list-style-type: none"> Convey warm water to 100 cfs from East Branch NFFR to Rock Creek Reservoir by diversion/pipeline <p>Note: This measure is designed to protect the lower Belden Reach.</p>	<ul style="list-style-type: none"> Construct Yellow Cr/ Belden PH bifurcation or, Convey Yellow Creek flows to 60 cfs by pipeline to Rock Creek Reservoir for plunging Construct low level outlet at Rock Creek Dam Dredge a submerged channel in Rock Creek Reservoir 	<ul style="list-style-type: none"> Convey cold Bucks Creek PH flows to 140 cfs to Cresta Reservoir for plunging by pipeline Construct low level outlet at Cresta Dam 	<ul style="list-style-type: none"> Increase Poe Dam release to 400 cfs Construct outlet/pipeline from the Poe Adit and release to 450 cfs of cooler water to the Poe Reach
	4b	<ul style="list-style-type: none"> Install Prattville thermal curtain Use Caribou #1 preferentially over Caribou #2 		<ul style="list-style-type: none"> Increase Rock Creek Dam release to 400 cfs 	<ul style="list-style-type: none"> Bypass cold Bucks Creek PH flows to 95 cfs around Cresta Reservoir by diversion/pipeline 	
	4c	<ul style="list-style-type: none"> Repair/modify Canyon Dam low level outlet and increase release to 600 cfs (and decrease Prattville Intake release commensurately) Use Caribou #1 preferentially over Caribou #2 		<ul style="list-style-type: none"> Construct 150 cfs capacity water chiller at Rock Creek Dam 	<ul style="list-style-type: none"> Construct 175 cfs capacity water chiller at Cresta Dam 	<ul style="list-style-type: none"> Construct 200 cfs capacity water chiller at Poe Dam
5. Reduce the temperature in Belden Forebay to 19.5 °C. (8 variations)	5a	<ul style="list-style-type: none"> Use Caribou #1 preferentially over Caribou #2 Repair/modify Canyon Dam low level outlet and increase release to 250 cfs or higher (and decrease Prattville Intake release commensurately) 	<ul style="list-style-type: none"> Convey cold Seneca Reach flows to 250 cfs to Belden Reservoir for plunging by diversion/pipeline Install a thermal curtain near Belden PH Intake Convey warm water to 100 cfs from East Branch NFFR to Rock Creek Reservoir by diversion/pipeline 	<ul style="list-style-type: none"> Construct Yellow Cr/ Belden PH bifurcation or, Convey Yellow Creek flows to 60 cfs by pipeline to Rock Creek Reservoir for plunging Convey lower Belden Reach flows to 140 cfs to Rock Creek Reservoir for plunging Dredge a submerged channel in Rock Creek Reservoir Construct low level outlet at Rock Creek Dam 	<ul style="list-style-type: none"> Convey cold Bucks Creek PH flows to 140 cfs to Cresta Reservoir for plunging by diversion/pipeline Dredge a submerged channel in Cresta Reservoir Construct low level outlet at Cresta Dam 	<ul style="list-style-type: none"> Increase Poe Dam release Construct outlet/pipeline from the Poe Adit and release the cooler water to the Poe Reach
	5b	<ul style="list-style-type: none"> Install thermal curtain near Caribou Intake in Butt Valley Reservoir Repair/modify Canyon Dam low level outlet and increase release to 250 cfs or higher (and decrease Prattville Intake release commensurately) 		<ul style="list-style-type: none"> Bypass Yellow Creek/Chips Creek flows to 80 cfs around Rock Creek Reservoir by diversion/pipeline 	<ul style="list-style-type: none"> Bypass cold Bucks Creek PH flows to 110 cfs around Cresta Reservoir by pipeline 	
	5c	<ul style="list-style-type: none"> Convey Butt Valley PH discharges to 2,000 cfs by pipeline to Butt Valley Res. near the Caribou Intake Repair/modify Canyon Dam low level outlet and increase release to 250 cfs or higher (and decrease Prattville Intake release commensurately) 	<ul style="list-style-type: none"> Operate Caribou PHs in strict peaking mode with several hours shut down Convey warm water to 100 cfs from East Branch NFFR to Rock Creek Reservoir by diversion/pipeline 	<ul style="list-style-type: none"> Increase Rock Creek Dam release to 600 cfs 	<ul style="list-style-type: none"> Increase Grizzly Creek releases to 100 cfs 	<ul style="list-style-type: none"> Construct 200 cfs capacity water chiller at Poe Dam
			<ul style="list-style-type: none"> Construct 150 cfs capacity water chiller at Rock Creek Dam 	<ul style="list-style-type: none"> Construct 175 cfs capacity water chiller at Cresta Dam 		

**Table ES-2 Final Level 2 Alternatives to Achieve the 20°C Objective Target for Water Temperature along the NFFR
(Continued)**

Alternative Category	Alternative		Variations for Cooling Downstream Reaches			
	Alt.	Measures in reducing source water temperature to Belden Forebay	Additional measures for Belden Reach	Additional measures for Rock Creek Reach	Additional measures for Cresta Reach	Additional measures for Poe Reach
6. Reduce temperatures in all downstream reaches. (eliminated)	6a	No	<ul style="list-style-type: none"> Repair/modify Canyon Dam low level outlet and increase release to 250 cfs Convey cold Seneca Reach flows to Belden Reservoir for plunging by diversion/pipeline Increase Belden Dam/Oak Flat PH release to 250 cfs Convey warm water to 100 cfs in East Branch NFFR to Rock Creek Reservoir by diversion/pipeline 	<ul style="list-style-type: none"> Bypass lower Belden Reach flows to 250 cfs around Rock Creek Reservoir by diversion/pipeline <p>Note: Must be combined with bypassing Seneca flows around Belden Reservoir.</p>	<ul style="list-style-type: none"> Bypass lower Rock Creek Reach flows to 250 cfs around Cresta Reservoir by diversion/pipeline <p>Note: Must be combined with bypassing Seneca flows around Belden Reservoir.</p>	<ul style="list-style-type: none"> Bypass lower Cresta Reach flows to 250 cfs around Poe Reservoir by diversion/ pipeline <p>Note: Must be combined with bypassing Seneca flows around Belden Reservoir.</p>
	6b		<ul style="list-style-type: none"> Increase Canyon Dam low level outlet release to 90 cfs or higher Operate Caribou PHs in strict peaking mode with several hours shut down Convey warm water to 100 cfs in East Branch NFFR to Rock Creek Reservoir by diversion/pipeline 	<ul style="list-style-type: none"> Construct 150 cfs capacity water chiller at Rock Creek Dam 	<ul style="list-style-type: none"> Construct 175 cfs capacity water chiller at Cresta Dam 	<ul style="list-style-type: none"> Construct 200 cfs capacity water chiller at Poe Dam
	6c		<ul style="list-style-type: none"> Convey cold water from Lake Oroville to below Belden Dam 	<ul style="list-style-type: none"> Convey cold water from Lake Oroville to below Rock Creek Dam 	<ul style="list-style-type: none"> Convey cold water from Lake Oroville to below Cresta Dam 	<ul style="list-style-type: none"> Convey cold Lake Oroville to below Poe D.

1.0 INTRODUCTION

1.1 PURPOSE AND SCOPE

The purpose of this Level 1 and 2 Report is to document the development and screening of *potentially* feasible water temperature reduction alternatives for seasonal cooling of water temperatures along the North Fork Feather River (NFFR) to achieve the water quality objective and protect the designated cold freshwater habitat beneficial use⁶. A subsequent Level 3 Report will expand on the water temperature reduction alternatives passing Level 2 screening, and will document the development of *confirmed* feasible water temperature reduction alternatives that could be incorporated into California Environmental Quality Act (CEQA) alternatives⁷ and carried forward in the CEQA process. The State Water Resources Control Board (State Water Board) will use this report and the subsequent Level 3 Report to support, in part, its actions regarding issuance of Clean Water Act (CWA) section 401 water quality certification and adoption of an adequate CEQA Environmental Impact Report (EIR) for the certification. The geographic extent of the water temperature reduction alternatives covers the NFFR and its tributaries from Lake Almanor to the point of discharge to Lake Oroville. Most of the water temperature reduction alternatives under consideration are located along the mainstem NFFR.

Portions of the NFFR do not meet the water quality standards for water temperature as set forth in the Water Quality Control Plan for the Central Valley Region (Basin Plan; California Regional Water Quality Control Board, Central Valley Region 2004, amended 2006). The State Water Board has determined that elevated water temperatures are impairing the cold freshwater habitat beneficial use of the NFFR, as designated in the Basin Plan. On October 25, 2006, in accordance with CWA Section 303(d), the State Water Board approved placement of the NFFR (below Lake Almanor) on the list of water quality limited segments (State Water Board Resolution No. 2006-0079). The State Water Board cited water temperature as a pollutant that is causing impairment to the cold freshwater habitat beneficial use, and specified hydromodification and flow regulation as potential sources of the impairment. On November 30, 2006, the U.S. EPA approved this 303(d) listing (U.S. EPA's 2004-2006 Clean Water Act Section 303(d) List of Water Quality Impaired Segments for California).

PG&E's hydroelectric facilities are known to contribute to warming of water in the NFFR. These facilities, including a series of dams and reservoirs, powerhouses, and diverted stream reaches, prolong the hydraulic residence time, modify the thermal structure of the river, and alter the magnitude and timing of stream flows. These variations from natural hydrologic conditions alter the heat exchange characteristics of the river and contribute to warming that impairs cold freshwater habitat beneficial use, particularly during the summer.

⁶ A *water temperature measure* is defined as a physical or operational modification implemented at a specific location that is intended to reduce water temperature. A *water temperature reduction alternative* is defined as a combination of individual water temperature measures that act collectively to reduce water temperature, achieve the water quality objective, and protect the designated cold freshwater habitat beneficial use along the NFFR.

⁷ Water temperature reduction alternatives are differentiated from comprehensive CEQA alternatives in the sense that water temperature reduction alternatives address only water temperature concerns. Comprehensive CEQA alternatives include water temperature reduction alternatives plus additional measures to address other environmental resource concerns.

PG&E submitted an application to the Federal Energy Regulatory Commission (FERC) for a new federal license for its Upper North Fork Feather River Project (UNFFR Project; FERC No. 2105). Prior to issuance of the new FERC license, CWA water quality certification must be obtained (18 C.F.R. §4.34, subd. (b)(5)(i)). Section 401 of the CWA (33 U.S.C. § 1341) requires certification that the Project will be in compliance with specified provisions of the CWA, including state water quality standards contained in the applicable Basin Plan (401 certification) and provides that the conditions of certification become conditions of the new federal license. The State Water Board is responsible for certifying hydroelectric projects in California (Wat. Code, § 13160; Cal. Code Regs., tit. 23, § 3855, subd. (b)), including the UNFFR Project.

The State Water Board's issuance of 401 certification is a discretionary action subject to compliance with CEQA. Because of project complexity, the level of controversy surrounding unresolved temperature issues on the UNFFR Project, and the likelihood of significant impacts, the State Water Board as the CEQA lead agency, made the decision to prepare an EIR. Consistent with CEQA, the EIR must evaluate a reasonable range of alternatives (CEQA Guidelines, § 15126, subd. (d)). The development of potentially feasible water temperature reduction alternatives documented in this report finishes an important initial stage toward defining comprehensive CEQA alternatives that could be analyzed in the EIR.

1.2 BACKGROUND

In deciding whether to issue 401 certification, the State Water Board will determine whether the UNFFR Project achieves the water quality objectives for affected water bodies and adequately protects the beneficial uses, as designated in the Basin Plan. The Basin Plan designates beneficial uses, including cold freshwater habitat, hydropower generation⁸ and others, for two discrete water bodies associated with the UNFFR Project, Lake Almanor and the NFFR⁹. The Basin Plan provides numeric and narrative objectives for water temperatures in the NFFR. The numeric objective states: "At no time or place shall the temperature be increased more than 5° Fahrenheit (°F) above the natural receiving water temperature." The narrative objective states: "The natural receiving waters shall not be altered unless it can be demonstrated to the satisfaction of the Regional Water Board that such alteration in temperature does not adversely affect beneficial uses." In order to meet this narrative temperature objective, a numeric requirement must be developed on a case-by-case basis that affords adequate protection to the designated beneficial uses for the specific water body.

The State Water Board's assessment of temperature conditions, for purposes of CWA section 303(d) determination of impairment to cold freshwater habitat beneficial uses, was based on values established in the Water Quality Control Policy for Developing California's CWA Section 303(d) List (State Water Board Resolution No. 2004-0063). In listing the NFFR for temperature impairment the State Water Board used the following water quality evaluation criteria:

- 7-day mean water temperature 17.0°C

⁸ The Basin Plan defines cold freshwater habitat as uses of water that support coldwater ecosystems that may include, but are not limited to, preservation and enhancement of aquatic habitats, vegetation, fish, and wildlife, including invertebrates. Hydropower generation is defined as uses of water for hydroelectric power generation.

⁹ Additional information concerning the Basin Plan and designated beneficial uses for these two water bodies and their tributaries is available at the following web site: <http://www.waterboards.ca.gov/centralvalley/>.

- Maximum weekly water temperature 19.6°C
- Maximum annual average water temperature 21.0°C

In determining the appropriate numeric temperature requirement as part of the 401 certification process, the State Water Board is not necessarily bound to follow the same criteria that it used in the 303(d) listing process, but the State Water Board will consider all of the information that supported development of the guidelines used during the 303(d) listing process, together with any other reliable information.

Achievement of water quality objectives depends on applying them to controllable water quality factors. The Basin Plan defines controllable water quality factors as those actions, conditions or circumstances resulting from human activities that may influence water quality, that are subject to the authority of the State or Regional Water Board, and that may reasonably be controlled. Accordingly, in deciding whether to issue 401 certification, the State Water Board will also consider feasible modifications to the UNFFR Project to address controllable factors contributing to seasonal warming of the NFFR. There may be feasible and effective temperature reduction methods other than modifications to the UNFFR Project available to PG&E to address controllable factors contributing to warming of the NFFR. These other methods may involve physical or operational modifications to PG&E’s other hydroelectric projects in the NFFR watershed, and some of these may have lesser adverse environmental impacts than measures within the UNFFR Project. Accordingly, consistent with the CEQA requirement that alternatives be considered that would eliminate or reduce adverse environmental impacts (CEQA Guidelines, § 15126.6, subd. (c)), development of temperature reduction methods other than feasible modifications to the UNFFR Project is also covered in this report.

Impacts of the UNFFR Project on downstream water temperatures have been recognized since 1980 when PG&E, along with the CDFG, began fishery and water temperature studies of the NFFR in connection with the relicensing of the Rock Creek–Cresta Project (FERC No. 1962). In that relicensing effort, a settlement agreement (Rock Creek–Cresta Relicensing Settlement Agreement, 2000) stipulated that additional studies be conducted to determine the feasibility of modifying UNFFR Project facilities, operations, or other measures to achieve desired water temperatures in the NFFR. Conditions of the settlement agreement and the recent FERC License No. 1962 (FERC 2001) establish goals for restoring water temperatures of 20°C or lower through the Rock Creek and Cresta Reaches of the NFFR to protect the cold freshwater habitat beneficial use.

FERC prepared a Final Environmental Impact Statement (EIS) for the relicensing of the UNFFR Project (FERC, 2005) pursuant to NEPA. The document evaluated the effects of continued Project operations in accordance with environmental measures presented in a partial settlement agreement, Project 2105 Relicensing Settlement Agreement (Partial Settlement; 2004) signed by various stakeholders in the Project 2105 Collaborative Licensing Group (Licensing Group). Although State Water Board staff provided guidance to the Licensing Group, the State Water Board was not a party to the Partial Settlement. The Licensing Group negotiated agreements on many Project-related resource issues, but it was unable to achieve consensus on matters related to water temperature, shoreline erosion, and wetlands. Thus, the Partial Settlement identifies several unresolved issues which fall within the jurisdictional mandates of the State Water Board, including water temperature. State Water Board staff have determined that the Final EIS is not adequate to support the 401 certification process because it does not address all water quality

impacts and other resource issues, and does not fully satisfy the requirements of CEQA. In fact, FERC selectively requested additional comments on the final EIS analysis of potential measures to provide colder water to the NFFR. Due to project complexity and the level of controversy surrounding the FERC relicensing efforts, the State Water Board has determined that an EIR is required to comply with CEQA and to fully disclose measures necessary for a 401 certification.

1.3 DESCRIPTION OF THE UNFFR PROJECT

For purposes of CEQA, the proposed project can be defined as the operation of the existing UNFFR Project as presented in PG&E's Application for License of the UNFFR Project (PG&E 2002) plus the protection, mitigation, and enhancement (PM&E) measures proposed for the UNFFR Project, as described in the Partial Settlement. The following section provides a brief overview of the UNFFR Project facilities, the operational configuration, and the changes to the existing UNFFR Project as proposed in the Partial Settlement.

The facilities of the UNFFR Project include three dams that impound water from the NFFR and Butt Creek, five powerhouses (PH), and three stream bypass reaches. Figures 1-1a and 1-1b show the locations and relationships of dams, impounded reservoirs, and bypass reaches associated with the UNFFR Project. Generation and transmission facilities are shown on these figures, as well as the recreational facilities located near the reservoirs and bypass reaches. The UNFFR Project also includes numerous roads and administrative facilities to support hydroelectric operation and maintenance activities.

UNFFR Project reservoirs include Lake Almanor (1,142,251 acre-feet), Butt Valley Reservoir (49,897 acre-feet), and Belden Forebay (2,477 acre-feet). Generation capacity is provided by Butt Valley PH (41 MW), Caribou No. 1 PH (75 MW), Caribou No. 2 PH (120 MW), Oak Flat PH (1.3 MW), and Belden PH (125 MW). Project dams at the three reservoirs regulate bypass flows released to the diverted reaches of the NFFR, including the Seneca Reach (below Canyon Dam) and Belden Reach (below Belden Forebay Dam). Butt Valley Dam, with no stream outlet structure, contributes minor leakage to lower Butt Creek in conjunction with a series of springs downstream of Butt Valley Dam.

Facilities of the UNFFR Project are operated in an integrated manner. Operation of the UNFFR Project is coordinated with other PG&E facilities in the NFFR watershed, including the upstream Hamilton Branch Project (unlicensed) and the downstream Rock Creek– Cresta (FERC No. 1962), Bucks Creek (FERC No. 619), and Poe (FERC No. 2107) Projects. Downstream of these hydroelectric projects, the waters of the NFFR flow into Lake Oroville, a feature of the FERC No. 2100 Project operated by the California Department of Water Resources, then into the Feather River, and ultimately into the Sacramento River system.

Under existing conditions, water levels in Lake Almanor, Butt Valley Reservoir, and Belden Forebay are controlled by License No. 2105 streamflow requirements and the operational decisions made by PG&E for power generation. Lake Almanor is managed to ensure that the lake level does not exceed the full-pool elevation of 4,504 feet in USGS Datum¹⁰ to avoid spill at Canyon Dam. Typically, outflows from Canyon Dam and the Prattville Intake are controlled in the spring to allow the lake to refill with snowmelt, though in dry years the lake may not

¹⁰ USGS Datum (NGVD 1929) = PG&E Datum + 10.2 feet.

completely fill. During the summer, the lake is managed for power generation and recreational opportunities. The Canyon Dam intake tower is designed to selectively draw from either the lower water column or higher in the lake strata, allowing some control over the temperature of flow releases¹¹. The Canyon Dam outlet structure has a maximum capacity of 2,100 cfs, but is generally operated to release only the required minimum instream flows to the Seneca bypass reach (Seneca Reach) of the NFFR. Although current minimum flow releases are established at 35 cfs, the Partial Settlement provides for a revised and variable flow release schedule that will be evaluated in the EIR.

Butt Valley Reservoir is operated to meet power system needs, while also providing recreational opportunities, including fishing, swimming, boating, and shoreline camping. Flow enters the reservoir from the upper reach of Butt Creek and from Lake Almanor through the Prattville diversion tunnel to the Butt Valley PH. Butt Valley Dam has no outlet structure for releasing water to the bypass reach of lower Butt Creek. Currently, there is no minimum instream flow requirement for Butt Creek, and all flow entering the reservoir is diverted through the Caribou PH No. 1 and No. 2 Intakes. A 1997 seismic retrofit of Butt Valley Dam altered the natural drainage course of Benner Creek, a tributary to Butt Creek located immediately below Butt Valley Dam, converting it from a perennial to an intermittent stream. Lower Butt Creek receives limited leakage from the bottom of the dam, and the operation of Caribou PH No. 1 (1,100 cfs capacity) and Caribou PH No. 2 (1,500 cfs capacity) prevent spill at the dam. The water surface elevation of Butt Valley Reservoir fluctuates by about 10 to 15 feet below the maximum water surface elevation of 4,142 feet (USGS datum) on an annual basis.

Belden Forebay functions as a regulating facility, buffering the effects of discharges from the Caribou PHs prior to intake of flows through the Belden tunnel or discharge through the Oak Flat PH at the toe of Belden Dam, to the Belden bypass reach (Belden Reach). Because it is a regulating impoundment, the operational parameters provide for daily surface-level fluctuations of up to 10 feet. These fluctuations may limit the type and quality of recreational opportunities at Belden Forebay. The Oak Flat PH, an integral part of Belden Dam, has a maximum capacity of 140 cfs and currently serves as the release structure for minimum flows to the Belden Reach. Minimum flow requirements for the Belden Reach are currently set at 60 cfs during fall and winter, with flow increases to 140 cfs during the spring and summer fishing season. Data indicate that summer water temperatures in the Belden Reach often exceed the thresholds protective of cold freshwater habitat. The Partial Settlement provides a revised flow release schedule, but does not include measures that fully address seasonal water temperature concerns.

In addition to the power generation beneficial use, the UNFFR Project facilities provide a range of recreational uses, including contact and non-contact water-based recreation. Lake Almanor and Butt Valley Reservoir offer a variety of recreational facilities, including campgrounds, marinas, and day-use areas. The Partial Settlement includes PM&E measures for recreation facilities at the reservoirs and along the NFFR that have been recommended for inclusion in a new license for the UNFFR Project.

¹¹ The Canyon Dam intake tower has three low level outlets gates – Gate #1, Gate #3, and Gate #5 – all located at elevation 4432 ft, about 72 ft below the maximum lake level elevation of 4504 ft USGS datum. These three low level gates are damaged or are in poor condition due to corrosion and long-term hydrostatic loading on the gates and gate-stems. PG&E inspections revealed the poor condition of the gate-stems, gate connections, and bolts. In August-October 2005 PG&E did repair work on Gate #5 and rehabilitated the gate and gate-stem connection. Gate #5 is the only low level gate that is currently operable, but its operation is limited and it can reliably and safely release up to only about 73 cfs.

1.4 OVERVIEW OF APPROACH TO THE DEVELOPMENT AND SCREENING OF POTENTIALLY FEASIBLE WATER TEMPERATURE REDUCTION ALTERNATIVES

This Level 1 and 2 Report documents the first two phases of a three-phased approach to the development of a reasonable range of feasible alternatives for achieving the water temperature objective and protection of the cold freshwater habitat beneficial use of the NFFR. Figure 1-2 presents the three-phased approach as a flow diagram.

To facilitate the analysis needed to develop alternatives that could address the temperature objectives established by the Basin Plan, a numerical value for the water temperature objective was deemed necessary (water temperature objective target or “temperature target”). In setting the temperature target value, it was recognized that it must be feasibly attainable through physical or operational modifications of the UNFFR Project, since the alternatives being developed are intended for support of the State Water Board’s 401 certification decision for relicensing of the FERC No. 2105 Project. Accordingly, for purposes of developing and screening water temperature reduction alternatives in this Level 1 and 2 Report, *a numerical value of 20°C maximum mean daily NFFR-wide was set as the water temperature objective target.*^{12,13} This initial numerical value could be modified in the subsequent Level 3 effort if, at that time, a different and more appropriate temperature target is determined to be feasibly attainable through modification or re-operation of the UNFFR Project.

Level 1 casts a “wide net” that captures most all of the possible water temperature reduction alternatives and then subjects these possible alternatives to the following coarse screening criteria:

- Effectiveness and reliability – Is there a reasonable potential that the alternative can effectively and reliably achieve the preliminary temperature target or, is the effectiveness and reliability of the alternative overly speculative?
- Technological feasibility and constructability – Can the alternative be implemented with currently available technology and construction methods?
- Logistics – Can the alternative be implemented when considering current legal obligations, regulatory permitting requirements, public safety needs, right-of-way and access needs, and other real world logistical constraints?
- Reasonability¹⁴ – Are there clearly more reasonable or superior alternatives available based on the other criteria? Is implementation of the alternative remote or highly speculative?

¹² This water temperature objective target was set only for purposes of developing and screening alternatives, and should not be construed as the numeric temperature requirement necessary to achieve compliance with the Basin Plan. The State Water Board will determine the appropriate numeric temperature requirement in its 401 certification decision.

¹³ The basis for this temperature target is further explained in Chapter 3.

¹⁴ An EIR need not consider an alternative whose effect cannot be reasonably ascertained and whose implementation is remote and speculative (CEQA Guidelines, § 15126, subd. (d)).

The set of alternative measures passing Level 1 screening represents a reasonable range of potentially effective and feasible water temperature reduction alternative measures that are carried forward to Level 2.

Level 2 screens-out (eliminates) those water temperature reduction alternatives passing Level 1 screening that, after closer examination, are ineffective, infeasible, or are clearly inferior to other alternatives. In Level 2 the alternatives are analyzed using the best resource information currently available. Water temperature reduction alternatives are modified or refined based on the analysis, and rough engineering designs and cost estimates are developed. The alternatives are subjected to the same screening criteria used in Level 1, plus the following additional criteria:

- Substantial Further Study - Is there sufficient information currently available or can it be readily developed in order to evaluate the potential effectiveness and feasibility of the alternative, or is substantial further investigation or study required?
- Environmental challenges – Are there obvious environmental consequences or problems associated with the alternative that would pose a major challenge to overcome?
- Economic feasibility – Can the alternative be implemented at a reasonable cost, including capital, O&M, and considering energy replacement costs?

The resulting Level 2 alternatives represent *the set of potentially effective and feasible water temperature reduction alternatives* that are advanced to Level 3. (A separate report will be prepared to document the Level 3 water temperature reduction alternatives analysis and screening efforts.)

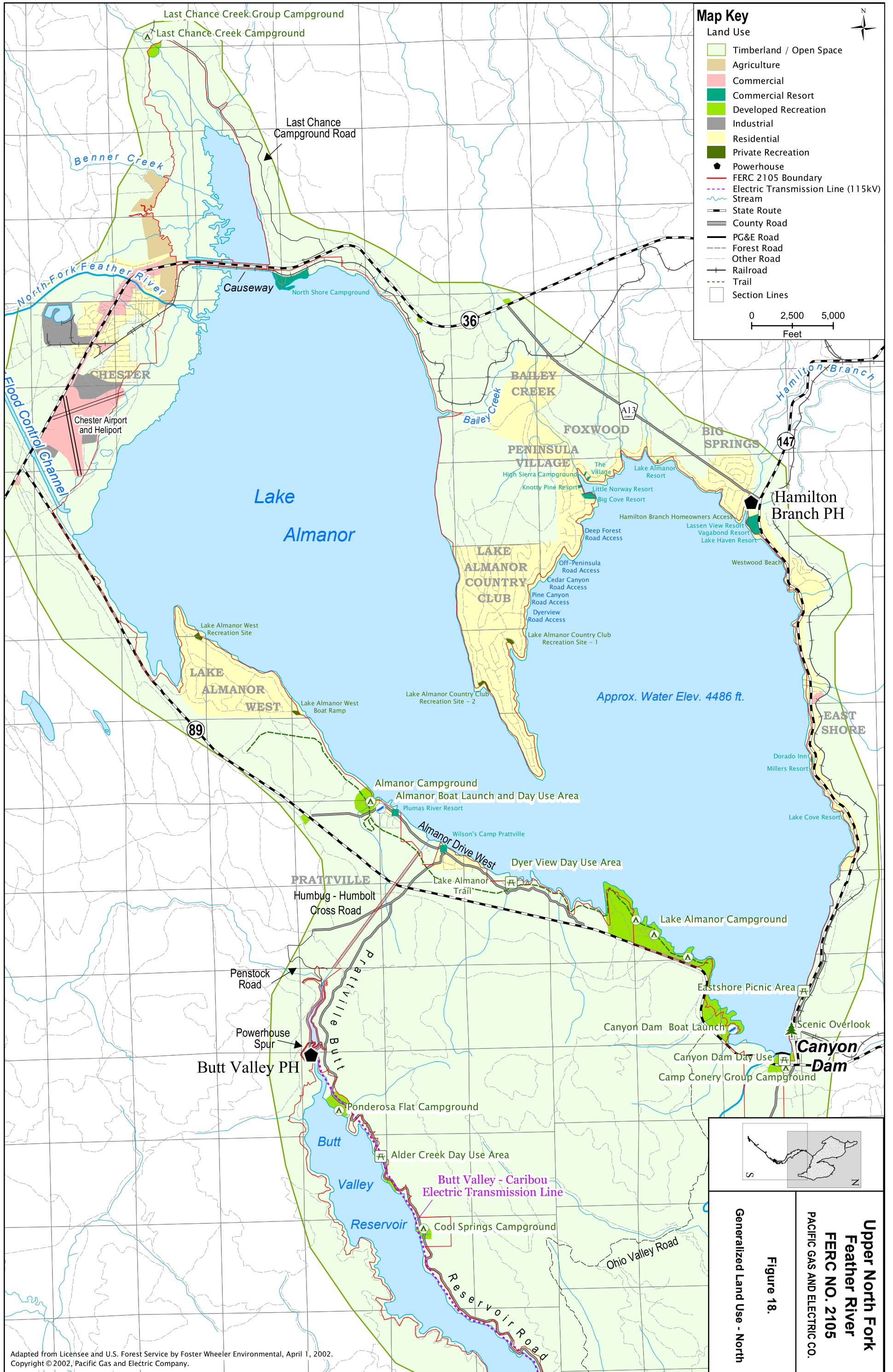
Prior to completing the Level 3 analysis and screening, additional detailed modeling, engineering design, and cost estimate work will be completed. This work will involve application of the newly developed water quality models and the newly modified existing hydrologic and temperature models in a detailed technical analysis. During Level 3 screening, these data and models will be used to carefully analyze the effectiveness, sustainability, and reliability of the water temperature reduction alternatives that advanced from Level 2. The temperature reduction alternatives may be further modified or refined based on the analysis, particularly if a new water temperature target is developed. The water temperature reduction alternatives verified to be effective, sustainable, and reliable will be designed to a feasibility-level of detail. The alternatives will then be screened based on the same screening criteria used in Level 1 and 2. The resulting set of water temperature reduction alternatives passing the Level 3 screening will represent *the set of effective and feasible water temperature reduction alternatives*. These water temperature reduction alternatives will be carried forward into the EIR as elements of the CEQA alternatives, where they may be augmented and/or modified to address potentially significant environmental impacts identified through the CEQA process.

1.5 OFF-SITE WATER TEMPERATURE MITIGATION

The County of Plumas has requested that the State Water Board analyze the “Watershed Restoration and Improvement Alternative (Watershed Alternative)” in the EIR for 401

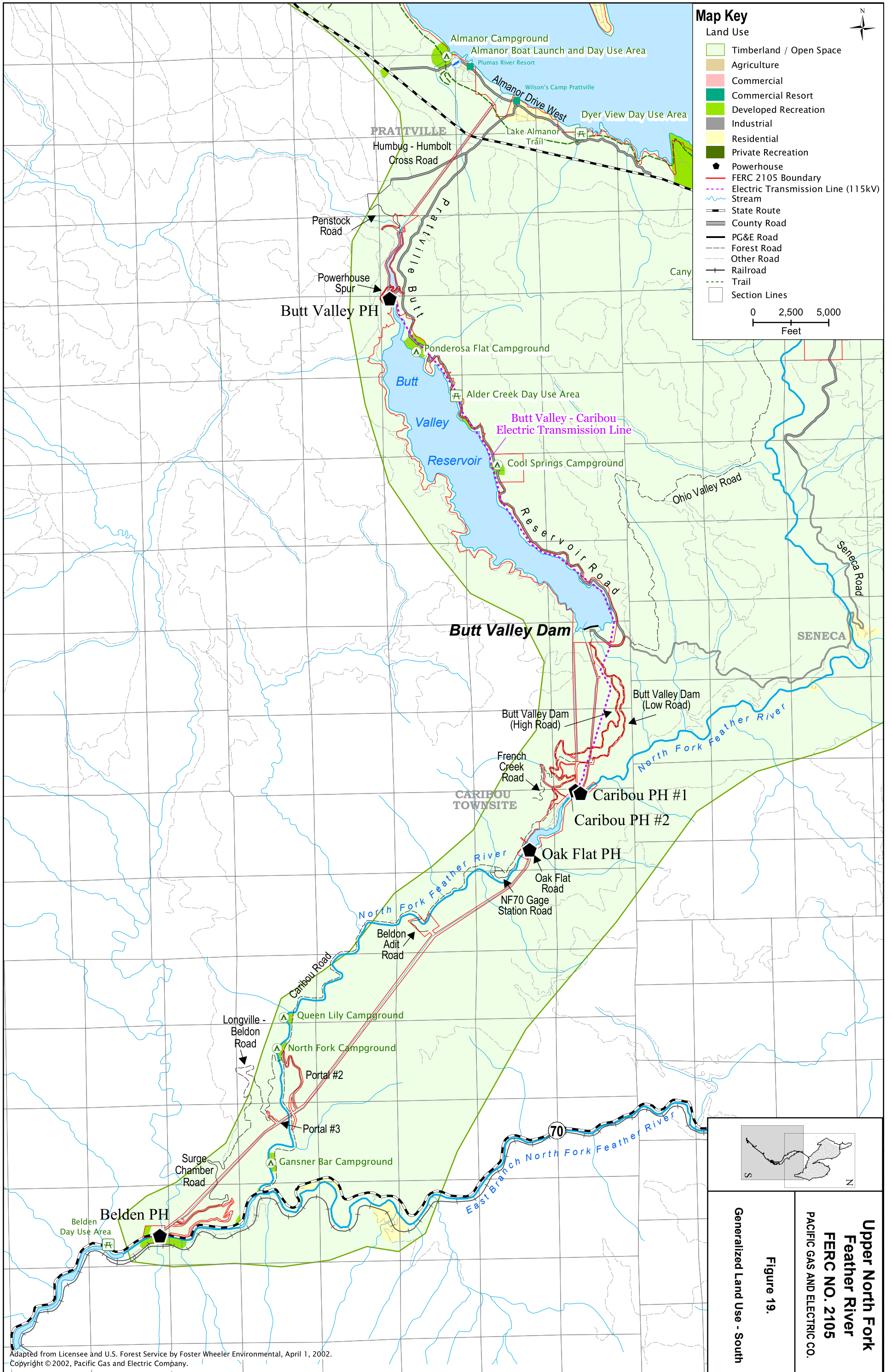
certification.¹⁵ The Watershed Alternative proposes “off-site mitigation” in the East Branch watershed in-lieu of achieving the water temperature objective and protecting cold freshwater habitat beneficial use in the NFFR through physical or operational modifications of the UNFFR Project. The State Water Board may consider the merits of this or other off-site compensatory mitigation in the future if all reasonable on-site temperature reduction alternatives are found to be infeasible, ineffective or unreasonable. However, in terms of quantifiable water temperature benefits in the NFFR, the Watershed Alternative provides no demonstration of effectiveness; therefore, it is not considered further in this Level 1 and 2 Report.

¹⁵ The Plumas County letter of request (October 17, 2005) and a description of the Watershed Alternative are provided in Appendix D.



Adapted from Licensee and U.S. Forest Service by Foster Wheeler Environmental, April 1, 2002.
 Copyright © 2002, Pacific Gas and Electric Company.

Upper North Fork Feather River FERC NO. 2105
PACIFIC GAS AND ELECTRIC CO.
Figure 18.
Generalized Land Use - North



Adapted from Licensee and U.S. Forest Service by Foster Wheeler Environmental, April 1, 2002.
 Copyright © 2002, Pacific Gas and Electric Company.

Upper North Fork Feather River
FERC NO. 2105
 PACIFIC GAS AND ELECTRIC CO.

Figure 19.
 Generalized Land Use - South

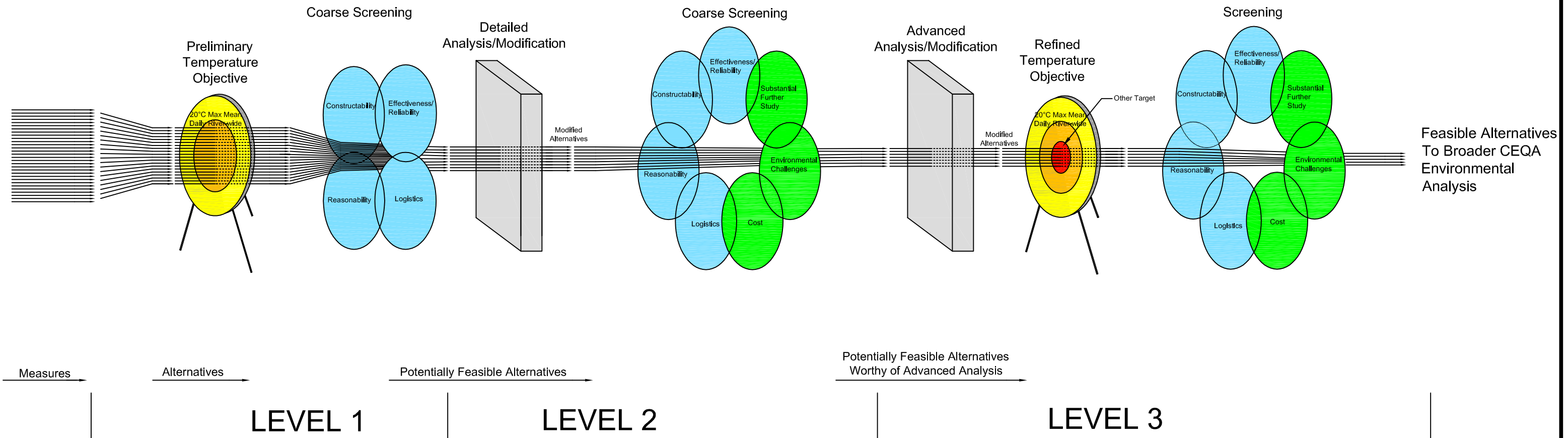


Figure 1-2

Upper North Fork Feather River: Alternatives Development and Evaluation Process Flow Diagram

2.0 THE SUMMER THERMAL REGIME OF THE NORTH FORK FEATHER RIVER AND THE RESPONSE TO THE INFUSION OF COLD WATER

This chapter characterizes the summer thermal regime of the NFFR and describes its response to the infusion of cold water. Infusion of cold water from some source will be necessary to achieve the Basin Plan temperature objective and protect the cold freshwater habitat beneficial use designated for the NFFR. The analysis and observations presented in this chapter are based on historical temperature data and recent data produced by PG&E through its special project re-operation and temperature testing and various NFFR monitoring efforts.

As discussed in Chapter 1, for purposes of this report a 20°C maximum mean daily water temperature throughout the NFFR is used as the water temperature objective target necessary for protection of cold freshwater habitat. Use of 20°C as the temperature target is consistent with the Rock Creek–Cresta Settlement Agreement and articles of FERC License No. 1962, which establish goals for restoring mean daily water temperatures of 20°C or lower in the Rock Creek and Cresta Reaches of the NFFR to protect the cold freshwater habitat beneficial use. Outside the summer months of most water years, water temperatures in the NFFR achieve the Basin Plan objective and are cool enough to protect cold freshwater habitat. But typically during the summer months, water temperatures below Belden Dam and downstream on the NFFR are warmer than 20°C.

2.1 GENERAL DESCRIPTION OF THE SUMMER THERMAL REGIME

The warming effects resulting from the PG&E hydroelectric facilities are first seen within the UNFFR Project at the upper end of the NFFR system and thermal effects intensify as flow passes through operations downstream. During the summer season, the upper layer of Lake Almanor warms to over 21°C. Water warmed in Lake Almanor is currently delivered to the NFFR through two pathways: (1) directly, by release at Canyon Dam to the NFFR and (2) indirectly, routed through Butt Valley Reservoir where it is further warmed before passing through the Caribou powerhouses to the NFFR. The water delivered to the NFFR through these two pathways is conveyed downstream and ultimately flows into Lake Oroville. As flow moves downstream, only about 10 percent of the water remains in the natural river channel; about 90 percent of the NFFR flow is diverted off-river and is conveyed downstream in large pipes or tunnels and run through an articulated system of powerhouses. The NFFR powerhouses discharge to four small regulating reservoirs; Belden, Rock Creek, Cresta, and Poe, where water is further warmed (Table 2-1 summarizes the physical characteristics of the NFFR reservoirs). Accretion flows from tributary sources enter the river as it courses downstream. The accretion flows are generally cool except for summer contributions from the East Branch, the largest tributary, which typically warms to greater than 20°C. Reservoir storage and the significant reduction in streamflow along diverted reaches increase heat exchange with the atmosphere which warms the water flowing in the river. Summer water temperatures in the NFFR from the Belden Reach below Belden Dam and downstream along every diverted reach to Lake Oroville are typically warmer than 20°C.

2.2 DETAILED DESCRIPTION OF THE SUMMER THERMAL REGIME BASED ON HISTORICAL MONITORING BY PG&E

Warming of the NFFR under current hydroelectric project operations is evident in data from an ongoing comprehensive water temperature monitoring program conducted by PG&E during summer months. The results of the 2002, 2003, and 2004 summer monitoring program are presented in Appendix A. The water temperature monitoring program for these years consisted of continuous stream flow and water temperature measurements at numerous stations along the NFFR. These monitoring stations are shown in Figure 2-1 and listed in Appendix A. In addition, PG&E performed temperature profile monitoring at all reservoirs along the lower NFFR in 1985. These data provide additional information on the thermal structures of the reservoirs and the availability of cold water at depth in each impoundment.

2.2.1 Summer Thermal Regime, 2002 – 2004

Water years 2002, 2003, and 2004 for the North Fork Feather River watershed were classified, in hydrologic terms, as “dry”, “normal”, and “normal” hydrologic years, respectively. The NFFR water temperature monitoring program results are summarized in Tables 2-2a and 2-2b (see also Appendix A). The number of days and calculated percentage of time that water temperatures exceeded the 20°C mean daily threshold are summarized in Tables 2-3a and 2-3b (see also Appendix B).

As shown in Table 2-3a, mean daily water temperatures in July and August exceeded the 20°C temperature target at all monitoring sites along the Belden, Rock Creek, Cresta, and Poe Reaches. The mean daily water temperature in the Belden Reach below Belden Dam (NF5) exceeded 20°C 100 percent of the time in August 2002 and 2004, with maximum mean daily water temperatures of 21.2°C in August 2002 and 21.8°C in August 2004 (Table 2-2a). High water temperatures in Belden Dam releases to the NFFR resulted from warm water discharges from the Caribou PHs (the primary source of water to Belden Reservoir). Caribou No. 2 PH had a mean daily discharge water temperature exceeding 20°C 100 percent of the time in both August 2002 and 2004 (Table 2-3b) and maximum mean daily discharge water temperatures of 23.7°C in August 2002 and 22.7°C in August 2004 (Table 2-2b). High discharge temperatures at the Caribou PHs resulted from high water temperature in the Butt Valley PH discharge (the primary source of water to Butt Valley Reservoir). Butt Valley PH discharges exceeded 20°C 100 percent of the time (Table 2-3b) and had a maximum mean daily discharge water temperature of 21.9°C in August 2002 and 21.8°C in August 2004 (Table 2-2b).

Table 2-3a shows that the mean daily water temperature in the Belden Reach above Belden PH (NF8) was significantly higher than other monitoring sites in the reach (Table 2-2a). This can be attributed to the warming effect of accretion flows from the East Branch, which had maximum mean daily water temperatures of 25.5°C, 26.4°C, and 24.8°C in 2002, 2003, and 2004, respectively (see Table A-1 in Appendix A).

2.2.2 Severe Summer Thermal Regime, July 2002

Water temperatures recorded during the month of July 2002 reflect the lowest flows, most extreme heat-inducing atmospheric conditions and, consequently, the warmest water

temperatures of the 2002 – 2004 summer monitoring period. A longitudinal temperature profile along the NFFR was developed based on the “worst case scenario” conditions represented by July 2002 measurements. Mass balance mixing and SNTMP modeling was used to enhance the detail of the profile where tributary stream inflows significantly influenced river temperatures (Figure 2-2). The observations below describe river segments where temperatures exceeded the water temperature target in the NFFR and bring to light the causal factors of temperature target exceedences.

- a. The Seneca Reach met the temperature target, generally exhibiting temperatures lower than 17°C. Inflow from Butt Creek had a cooling effect, but there was still considerable warming of about 4°C along the Seneca Reach as water traveled from Canyon Dam downstream to Belden Reservoir. This warming, however, was not a major causal factor of downstream target exceedences because Seneca flows represented a small proportion of the total inflow into Belden Reservoir (see next).
- b. The obvious jump in the temperature profile between the downstream end of the Seneca Reach and the beginning of the Belden Reach (below Belden Dam) reflects the warming of Belden Reservoir caused by releases from the Caribou PHs. These releases dominated the temperature of Belden Reservoir and, ultimately, the temperatures of releases from Belden Dam and beyond. In July 2002, Caribou PH releases contributed an average daily flow of about 617 cfs or 89% of the total inflow into Belden Reservoir while the Seneca Reach contributed an average daily flow of only about 75.9 cfs or 11% of the total inflow.
- c. The Belden Reach above the East Branch generally met the temperature target, but exceedences were frequent. Inflow from the East Branch (EB1 average temperature was 23.8°C; average flow was 80 cfs) had a considerable warming effect on the NFFR of about 1.5°C. This warming further contributed to downstream temperature target exceedences. Discounting the effects of the East Branch, the Belden Reach otherwise exhibited little atmospheric warming, limited to about 0.4°C.
- d. Compared to the jump in the temperature profile at Belden Reservoir, there was little change in the profile across Rock Creek Reservoir. This may be explained by the fact that Belden Reservoir was the dominant source for both the Belden Reach and Rock Creek Reservoir (delivered through Belden PH). Additionally, the effects of cold water inflow from Yellow Creek/Chips Creek moderated temperatures in Rock Creek Reservoir. In July 2002, Belden PH releases contributed an average daily flow of about 518 cfs or 63 % of the total inflow into Rock Creek Reservoir, while the Yellow Creek/Chips Creek contributed an average daily flow of only about 82.6 cfs or 10 % of the total inflow, and Belden Reach contributed an average daily flow of only about 227.5 cfs or 27 % of the total inflow.
- e. The Rock Creek Reach consistently exceeded the temperature target. Inflow from Bucks Creek and Bucks Creek PH had a considerable cooling effect of about 1°C. This cooling was sufficient to mask the atmospheric warming of about 0.5°C, but it was not sufficient to prevent downstream temperature target exceedences.
- f. Similar to Rock Creek Reservoir, there was little change in the temperature profile across Cresta Reservoir. This may be explained by the fact that Rock Creek Reservoir was the dominant source for both the Rock Creek Reach and Cresta Reservoir (delivered through

Rock Creek PH). In July 2002, Rock Creek PH releases contributed an average daily flow of about 756 cfs or 70 % of the total inflow into Cresta Reservoir while the Rock Creek Reach contributed an average daily flow of only about 324.2 cfs or 30 % of the total inflow.

- g. The Cresta Reach consistently exceeded the temperature target. Inflow from Grizzly Creek averaged 24 cfs or 9 % of the total flow in the Cresta Reach, and had a very small cooling effect of about 0.1°C (GR1 average temperature was 19.3°C). This cooling was not sufficient to mask the atmospheric warming of about 0.5°C, nor prevent downstream temperature target exceedences.
- h. Similar to Rock Creek and Cresta Reservoirs, there was little change in the temperature profile across Poe Reservoir. This may be explained by the fact that Cresta Reservoir was the dominant source for both the Cresta Reach and Poe Reservoir (delivered through Cresta PH). In July 2002, Cresta PH releases contributed an average daily flow of about 820 cfs or 76 % of the total inflow into Poe Reservoir while the Cresta Reach contributed an average daily flow of only about 265 cfs or 24 % of the total inflow.
- i. The Poe Reach consistently exceeded the temperature target. There was no significant source of cool surface inflow to the Poe Reach; considerable warming of about 2 to 3°C occurred as flow traveled from the Poe Dam downstream to the Poe PH. During July 2002, the maximum mean daily temperature was 24.7°C and the average mean daily temperature was 23.7°C.
- j. The maximum mean daily temperatures in July 2002 were higher than the average mean daily temperatures along the entire NFFR as follows: about 0.7°C higher on Seneca Reach, 1.7°C higher on Belden Reach, 1.2°C higher on Rock Creek Reach, 1.0°C higher on Cresta Reach, and 1.0°C higher on Poe Reach.

2.2.3 Reservoir Water Temperature Profiles

Historical temperature profile data from monitoring conducted at Belden, Rock Creek, Cresta, and Poe Reservoirs was examined to assess the potential for thermal stratification and the availability of cooler waters at depth. In 1985, as part of the cold water feasibility study for the Rock Creek-Cresta Project (Woodward-Clyde Consultants 1986), PG&E performed temperature monitoring of all reservoirs along the NFFR. The monitoring results are illustrated in Figures 2-3 – 2-6 and summarized by reservoir below:

- a. The June 21, 1985 temperature profiles in Belden Reservoir indicated a relatively well-developed thermal structure, including a relatively well mixed epilimnetic layer with surface water temperature at about 22°C and a cold hypolimnion with bottom water temperature at about 11°C (Figure 2-3a). This may have resulted from cold water left over from the winter-spring period since increased fish-flow releases from the low level outlet at Oak Flat PH were not made until late June. Because there was considerably less cold water entering the reservoir over the summer (the only source of cold water entering the reservoir would have been from the Seneca Reach, which would have been about 65 cfs – 75 cfs with a water temperature of about 15 – 16°C in July), there was a weakening trend in the thermal stratification as the summer months progressed (Figures 2-3b and 2-3c).

- b. The temperature profiles in Rock Creek Reservoir showed a very weak thermal structure (Figure 2-4). Overall temperature differences between the top and bottom of the reservoir were less than 2°C. Yellow Creek and Chips Creek are the cold water sources to the reservoir. Flows from these two creeks in July are approximately 60 - 90 cfs and 25 - 40 cfs, respectively.
- c. The temperature profiles in Cresta Reservoir (Figure 2-5) and Poe Reservoir (Figure 2-6) indicated that the two reservoirs were well mixed vertically. There were no cold water sources to these two reservoirs during the summer of 1985.
- d. The weak stratification in Belden Reservoir and Rock Creek Reservoir could be affected by selective ON/OFF peaking operations of Caribou PHs and Belden PH, respectively. Cold water from the Seneca Reach generally mixes with warm water discharges from Caribou PHs during on-peak hours; and, during off-peak hours when it doesn't mix, the cold water will plunge to the bottom of Belden Reservoir. This phenomenon is demonstrated in Figure 2-7 which shows that the release water temperature from the low-level outlet at Oak Flat PH during Caribou PH off-peak hours is about 1°C cooler than during on-peak hours (Note: diurnal air temperature cycle would be a very minor contributing factor to the variation of water temperature at NF5 because the water is released from the reservoir bottom). Similarly, cold water from Yellow Creek probably mixes with warm water discharges from Belden PH during on-peak hours and partially mixes with warm water from the Belden Reach. The release temperature at Rock Creek Dam shows a trend similar to Belden Dam release temperature with respect to on-peak and off-peak operations (Figure 2-8).

2.3 THERMAL RESPONSE TO THE INFUSION OF COLD WATER

The infusion of cold water from an appropriate source will likely be necessary to achieve the temperature objective target of 20°C for protection of the cold freshwater habitat beneficial use along the NFFR. To assess the thermal response of the river to the infusion of cold water, PG&E carried out special tests in 2003 and 2006. The tests consisted of modifying the operations of certain NFFR hydroelectric project facilities to infuse cold water into the river, coupled with monitoring of flow and temperature at strategic points along the river to measure the thermal response. The test results yielded important information that will be used in the development of water temperature reduction measures and alternatives that may be considered as possible solutions to the NFFR temperature concerns.

2.3.1 July 2003 Caribou PH Special Test

In July 2003, PG&E conducted a special short duration test of Caribou PH intake operations. The primary purpose of the special test was to investigate the effectiveness of preferential use of Caribou PH No. 1 over Caribou PH No. 2, as a measure to reduce temperatures in Belden Reservoir and downstream. But, the special test also provided the unique opportunity to observe and track the thermal response of the greater NFFR system to the introduction of cold water from the upstream source as might occur under an actual temperature reduction scheme.

The special test was carried out in three parts: Part 1 covered the six day period, 7/12-7/17/03, and involved almost exclusive use of Caribou PH No. 2; Part 2 covered the eight day period, 7/18-7/25/03, and involved almost exclusive use of Caribou PH No. 1; and Part 3 covered the five day period, 7/26-7/30/03, and involved use of both Caribou PHs No. 1 and No. 2 simultaneously, as is often PG&E's operating practice. Throughout the special test PG&E continued with the comprehensive water temperature and streamflow monitoring program (Table 2-4 and Figure 2-9), the results are summarized below:

- a. During Part 1 Caribou PH No. 2 was operated preferentially, flows ranged from about 1,076 to 1,270 cfs. The day 1 temperature of discharge to Belden Reservoir was 20.1°C, and increased to 21.0°C on day 6. Caribou PH No. 1 flows ranged from 0 to 66 cfs.
- b. During Part 2 Caribou PH No. 1 was operated preferentially, flows ranged from about 564 to 997 cfs. The day 1 temperature of discharge to Belden Reservoir was 16.4°C, and increased steadily to 18.4°C by day 8 as the cold water pool in Butt Valley Reservoir was depleted. Caribou PH No. 2 flows ranged from 0 to 67 cfs.
- c. The initial drop of 4.6°C during the transition from Caribou PH No. 2 operation to Caribou PH No. 1 operation was the largest difference measured between Parts 1 and 2. As Part 2 of the special test progressed, the temperature in the discharge to Belden Reservoir increased.
- d. During the initial three days of Part 2, in response to cooler inflow from Caribou PH No. 1, Belden Reservoir (BD1) temperature dropped to a minimum of 17.3°C on day 3 (a drop of 3°C from the last day of part 1). Thereafter, Belden Reservoir temperature steadily rose; suggesting a response to increasing temperature in the Caribou PH No. 1 discharge with depletion of the cold water pool in Butt Valley Reservoir.
- e. Temperatures in the NFFR below Belden Dam (NF5) showed a trend similar to that measured in Belden Reservoir; that is, an initial drop followed by a steady rise during Part 2. In response to cooler inflow from Caribou PH No. 1, which caused Belden Reservoir temperature to drop, the NFFR below Belden Dam temperatures dropped to a minimum of 17.1°C on day 3 (a drop of 2.5°C from the last day of Part 1). Thereafter, temperatures in the NFFR below Belden Dam steadily rose; again, presumably, partially in response to increasing temperature in the Caribou PH No. 1 discharge which caused a rise in Belden Forebay Reservoir.
- f. Farther downstream the temperatures followed a similar trend, but the reduction effect of selectively using Caribou PH No. 1 dampened and diminished.
 - i) Temperatures in the NFFR above the East Branch (NF7) dropped to a minimum of 18.5°C on day 3 (a drop of 1°C from the last day of Part 1), and thereafter steadily rose.
 - ii) Temperatures in the NFFR above Yellow Creek (but below East Branch; NF8) showed no discernible effect from the Part 2 test, probably due to the masking effect of warmer water from the East Branch.
 - iii) Temperatures in the NFFR below Rock Creek Dam (NF9) dropped to a minimum of 19.1°C on day 3 (a drop of 1.1°C from the last day of Part 1), and thereafter steadily rose.
 - iv) Temperatures in the NFFR below Cresta Dam (NF14) dropped to a minimum of 19.6°C on day 3 (a drop of 0.3°C from the last day of Part 1), and thereafter rose.

- v) Temperatures in the NFFR below Poe Dam dropped to a minimum of 20°C on day 3 (a drop of 0.3°C from the last day of Part 1), and thereafter rose.
- g. The special test data also indicated possible thermal stratification and the availability of cooler water at depth in Belden Reservoir. Comparison of temperature measured at Belden Reservoir (BD1; temperature probe is at a depth of 20-30 ft, reflecting temperatures near the surface) and NFFR below Belden Dam (NF5; reflecting temperatures released from Oak Flat PH which release water at a depth of 90-100 ft) indicated possible stratification when temperatures in Belden Reservoir (as measured at BD1) were higher than 19°C. Oak Flat PH release temperatures were about 1 – 2°C lower than Belden Reservoir temperatures when the reservoir temperatures were higher than 19°C. The difference was less than 1°C when reservoir temperatures were lower than 19°C (Figure 2-10). During Part 2, as there were no significant water temperature differences between Caribou PH No.1 discharges and Seneca Reach flows, Oak Flat PH release temperatures were close to Belden Reservoir temperatures.
- h. The special test data also show that temperatures at NFFR below Rock Creek Dam were higher than estimated temperatures in Rock Creek Reservoir, indicating that warming occurred in Rock Creek Reservoir¹⁶. This warming was estimated at about 1°C when Rock Creek Reservoir was lower than about 19 °C (which occurred when the Belden Reservoir temperature was about 18°C or lower). The warming ceased when the Rock Creek Reservoir and Belden Forebay were both about 19.5°C or higher (Figure 2-11). Total warming from Belden Reservoir Dam to Rock Creek Reservoir was influenced by two factors; one was the warming along the lower Belden Reach due primarily to the East Branch, and the other was the warming within Rock Creek Reservoir. Total warming was about 2°C during the Caribou PH special test when the Belden Reservoir temperature was about 17.5 -18.0°C. This total warming resulted in minimal water temperature reduction along the Cresta and Poe Reaches during the July 2003 Caribou PH special test.

2.3.2 Summer 2006 Special Test

Further special testing of the thermal response of the river to project re-operation and the infusion of cold water was conducted during the summer of 2006¹⁷. The summer 2006 special test was designed to fill additional water temperature data needs determined after careful examination of the available historical data. Specifically, the objectives of the summer 2006 special testing were:

- To further assess the thermal response of the river to the infusion of cool water, and to evaluate, through actual operation and field measurement, the effectiveness of certain water temperature reduction measures; and,

¹⁶ Since temperature measurements were not taken in Rock Creek Reservoir, the reservoir temperature was estimated by mass balance mixing calculations using flow and temperature data from the four reservoir inflow sources; Yellow Creek above Belden Powerhouse (YC1), Belden Powerhouse (BD2), NFFR above Yellow Creek (NF8), and Chips Creek (CHIP1).

¹⁷ Refer to 2006 North Fork Feather River Special Testing Data Report (Stetson and PG&E 2007) for detailed information on the Summer 2006 Special Test.

- To provide data to support development of new or enhancement of existing computer simulation models of water temperature for evaluating water temperature reduction measures.

2.3.2.1 Description of the Special Test

This special test actually consisted of six separate special tests. All tests were conducted during summer 2006. Following are descriptions of the tests:

- **Special Tests 1, 2 and 4 - Increased Canyon Dam Release Test with Restricted Peaking Operations for Caribou PH No. 2**

The purpose of these special tests was to better understand the effects of increased release of cold water from the Canyon Dam low level outlets on the thermal structure at Belden Reservoir under conditions that avoided disturbance and mixing with warm Caribou PH discharges. Additionally, these special tests were designed to (1) evaluate Belden Reservoir thermocline development and sustainability as the cold water density current moved through the reservoir, (2) monitor the water temperature of Belden Dam releases through Oak Flat PH, and (3) characterize the thermal responses in the downstream reaches of the NFFR (e.g., Rock Creek, Cresta, and Poe reaches).¹⁸ Special Test 1 released cold water at 90 cfs; Special Test 2 released cold water at 250 cfs; and Special Test 4 released cold water at 600 cfs.

The design of these special tests was based on the hypothesis that denser cold water released from the Canyon Dam low level outlet, if undisturbed by Caribou PH discharge turbulence, would plunge as a density current into the bottom of Belden Reservoir during the Caribou PH No. 2 off-peaking hours. The plunged water would then move along the bottom of the reservoir toward Belden Dam, partially mixing with the ambient reservoir water along the way. During Caribou PH No. 2 on-peaking hours, the cold water from the Canyon Dam low level outlet would completely mix with warmer water discharged from Caribou PH No. 2.

- **Special Test 3 - Extended Off-Peaking Hours Test for Caribou PH No. 2 Concurrent with Increased Canyon Dam Release at 250 cfs**

The purpose of this special test was to better understand the influence that the duration of peaking operations at the Caribou PH No. 2 may have on the thermal structure of Belden Reservoir and the water temperature of Oak Flat PH releases. This special test was designed to assess whether extending off-peaking hours (3 additional hours off) of the Caribou PH No. 2 would cause a greater volume of cold water released from the Canyon Dam low level outlet to plunge to the bottom of Belden Reservoir, thereby strengthening the thermocline and enlarging the pool of cold water available for release from Oak Flat PH.

- **Special Test 5 - Caribou Special Test with Reduced Butt Valley PH Flows**

Data collected by PG&E during testing conducted August 1-5, 1994, suggested that decreasing the rate of Butt Valley PH discharge to below 800 cfs by reducing approach velocities at the Prattville Intake would, in effect, selectively withdraw water from the

¹⁸ Another element of Special Test 4, Yellow Creek flow bifurcation from Belden PH discharges, was deferred due to the long lead time that would have been needed to design and obtain the required regulatory permits for the instream bifurcation structure.

Lake Almanor hypolimnion and reduce the discharge water temperature.¹⁹ The purpose of Special Test 5 was to better understand the relationship between the rate and water temperature (and the associated dissolved oxygen level) of the Butt Valley PH discharge. This special test was also intended to help evaluate whether the cold water released from the Butt Valley PH (through a reduction in discharge rate) would plunge and travel the 5-miles through Butt Valley Reservoir to become available for withdrawal at the Caribou PH No. 1 Intake. This special test was designed to include collection of physical water quality data (temperature, dissolved oxygen and velocity) to better characterize hydraulic conditions within the reservoir with changes in water delivery temperature.

- **Special Test 6 - Increased Grizzly Creek Release Test**

The purpose of Special Test 6 was to better understand the effect that increasing the Grizzly Creek release rate may have on reducing warming along the creek to its confluence with the NFFR and, in addition, the resulting potential temperature reduction benefits available to the Cresta Reach. Historical flow releases from the Grizzly Forebay Dam low level outlet during the summer have been about 6 cfs. PG&E conducted water temperature monitoring along Grizzly Creek in the summer of 2002 at three locations: above Grizzly Forebay, below Grizzly Forebay, and near the mouth of Grizzly Creek. The measured mean daily flow near the mouth of Grizzly Creek in July and August 2002 ranged from 15 cfs to 28 cfs, which indicated a flow accretion of about 10 – 20 cfs. The measured water temperature below Grizzly Forebay in July and August 2002 ranged from 12°C to 15°C at the release rate of 6 cfs. The measured average warming in July and August 2002 from Grizzly Forebay to the mouth of Grizzly Creek was about 5.0°C. If increased release from Grizzly Forebay could shorten the travel time and thereby effectively reduce warming along the creek, water arriving at the confluence of Grizzly Creek with the NFFR should be significantly cold than the Cresta Reservoir releases to the NFFR. Thus, increasing Grizzly Creek releases should effectively reduce water temperatures along the Cresta Reach for some distance downstream.

In conjunction with the special tests, monitoring was carried out in compliance with Condition 4C of FERC License No. 1962 for the Rock-Creek-Cresta Project. The monitoring covered from Lake Almanor downstream to the Cresta PH and provided data to enhance understanding of the thermal responses of the entire NFFR system to cold water infusion during the special tests, changing reservoir operations, and meteorological conditions. Additional data was gathered from April through October as follows:

- Continuous monitoring of stream flow and water temperature at selected stations;
- Continuous monitoring of reservoir stage and water temperature at about 5 foot depth intervals in Lake Almanor, Butt Valley, Belden, and Rock Creek Reservoirs, as well as periodic water temperature profile monitoring at more refined intervals;
- Continuous monitoring of local meteorological conditions using PG&E's existing meteorology stations at Prattville Intake and Rock Creek Dam.

2.3.2.2 Observations from the Special Test

Following are summaries of the major findings of the special tests.

¹⁹ Source: Figure 7 in North Fork Feather River Study Data and Informational Report on Water Temperature Monitoring and Additional Reasonable Water Temperature Control Measures, PG&E, Amended September 2005.

- Special Tests 1 - 4 verified that the cold water plunge process will occur in Belden Reservoir during the Caribou PH No. 2 “off-peaking” hours, and the cold water will then move along the bottom to Belden Dam for release, partially mixing with ambient reservoir water along the way. Figure 2-13 shows the plunge test results observed at Belden Reservoir on July 22, 2006 (see Figure 2-12 for Belden Reservoir water temperature monitoring sites and transect x-section locations).

During July 22 monitoring, Caribou PH No. 1 was operating while Caribou PH No. 2 was totally shutdown. Under this re-operation test, cold water from Caribou PH No. 1 mixed with cold Seneca reach flows (about 14.0°C) and plunged into the bottom of Belden Reservoir. This plunging process is demonstrated in Figure 2-13. At transect X1, located about 500 ft upstream of data buoy BDR1 and approximately 700 ft below Caribou PH No. 2, the water temperature profile was uniform at about 14.2°C. Farther downstream at transect X2, located about 150 ft upstream of data buoy BDR1, stratified behavior was first observed in the water temperature profile. Field velocity profiles measured on July 22 during this stratified behavior showed higher velocity measurements near the reservoir bottom, indicating that the cold water plunged and moved along the reservoir bottom. In addition, slow reversal in surface water movement near the cold water plunging location (between transect X2 and transect X3) during the July 22 testing was observed and video recorded.

- Special Tests 1 – 4 demonstrated that entrainment and mixing of the ambient warm water of Belden Reservoir into the denser, cold inflowing water stream occurs both in the region of the plunge and after the cold inflow has assumed the form of a density current. Field test results have shown that the entrainment and mixing of ambient warm water into the cold inflowing current occurs mainly in the upstream portion of Belden Reservoir. As shown in Figure 2-13, bottom water temperature increased from about 14.3°C at transect X2 to about 16.3°C at transect X6. Downstream of transect X6, little warming was observed in the reservoir bottom water temperature. This indicates that entrainment and mixing of ambient warm surface water mainly occurred between transects X2 and transect X6. This suggests that conveying the cold Seneca flows directly to a location between transect X5 and transect X6 would help reduce the amount of warm water entrainment and mixing, and thereby preserve the cold water benefits of lower temperatures in releases from Belden Dam.
- During Special Tests 1 – 4, a thermally stratified condition was created in Belden Reservoir and the release water temperature at Belden Dam was relatively low compared to the warm surface water temperature. Figure 2-14 presents mean daily water temperatures at different depths in Belden Reservoir near Belden Dam (BDR2). Before the special tests, relatively weak stratification existed with water temperature decreasing linearly from water surface to bottom. During the special tests, the stratification was greatly strengthened, with an apparent hypolimnion layer below the 50 ft depth. After completion of the special tests, the defined stratification gradually returned back to the generally mixed condition observed before the special tests. It is important to note that, the Belden PH Intake did not access the cold water pool; instead, it withdrew warm water from the surface of the reservoir. The Belden PH discharge is the primary source of water to the downstream Rock Creek, Cresta, and Poe Reaches. This suggests that to reduce water temperatures in the downstream reaches, a measure that would cause the Belden PH Intake to draw from the deeper cold water pool would be effective.

- During the Special Tests 1 – 4, little stratification was observed in Rock Creek Reservoir (Figure 2-15). A longitudinal warming of 0.5 - 1.0°C through Rock Creek Reservoir was observed.
- Special Test 5 verified that decreasing the rate of Butt Valley PH discharge to below 800 cfs would selectively withdraw cold water from the Lake Almanor hypolimnion and lower discharge water temperatures to Butt Valley Reservoir. During this special test, the Butt Valley PH discharge was reduced from about 1,800 cfs to about 500 cfs, and measured water temperatures decreased from about 16.5°C to 12.5°C-13.0°C (Figure 2-16).
- Special Test 5 demonstrated that the cold water from Butt Valley PH (through a reduction in discharge rate to about 500 cfs) would plunge at a location near the Butt Valley Reservoir entrance. Figure 2-18 shows water temperature profiles collected from the upper portion of Butt Valley Reservoir during Special Test 5 (see Figure 2-17 for Butt Valley Reservoir water temperature monitoring sites and transect x-section locations). Water temperature profiles at transects X1 and X2 were generally uniform. Water temperature profiles at transects X3 and X4 showed relatively strong stratification, indicating that the cold water plunged at a location upstream of transect X3. Field observation indicated that the plunging location actually occurred immediately upstream of transect X3, where the wind-induced surface turbulence showed an interfacial line with the colder plunging water.
- During the Special Test 5, field efforts to trace the cold water plume in Butt Valley Reservoir were conducted. The intent was to capture and document the mixing process by measuring temperature and dissolved oxygen profiles at various points along the pathway of the cold water plume. A deeper channel was identified along the west side of the reservoir entrance above the Boat Ramp, but measurements could not locate the course of a distinct channel downstream of the Boat Ramp.
- Temperature stratification measurements in Butt Valley Reservoir indicated that the cold water that plunged moved primarily along the deeper channel with little entrainment or mixing with warm surface water. However, the mixing with warm surface water was relatively high from the Boat Ramp area, where the deeper channel began to disappear, to Cool Springs. This suggests that extending the deeper channel along the reservoir bottom toward the Caribou Intake structures may help reduce mixing with warm surface water during the movement of cold water along the reservoir bottom.
- Special Test 6 demonstrated that increasing the Grizzly Creek release rate would significantly reduce warming along the creek. During Special Test 6, increasing flow from 6 cfs to 20-50 cfs reduced the rate of warming in Grizzly Creek by about 2°C – 2.5°C. The cooler water contributions from Grizzly Creek to the NFFR reduced water temperature slightly in the Cresta Reach. It would be expected that higher releases to Grizzly Creek would further reduce warming along the creek and further reduce water temperatures in the Cresta Reach.

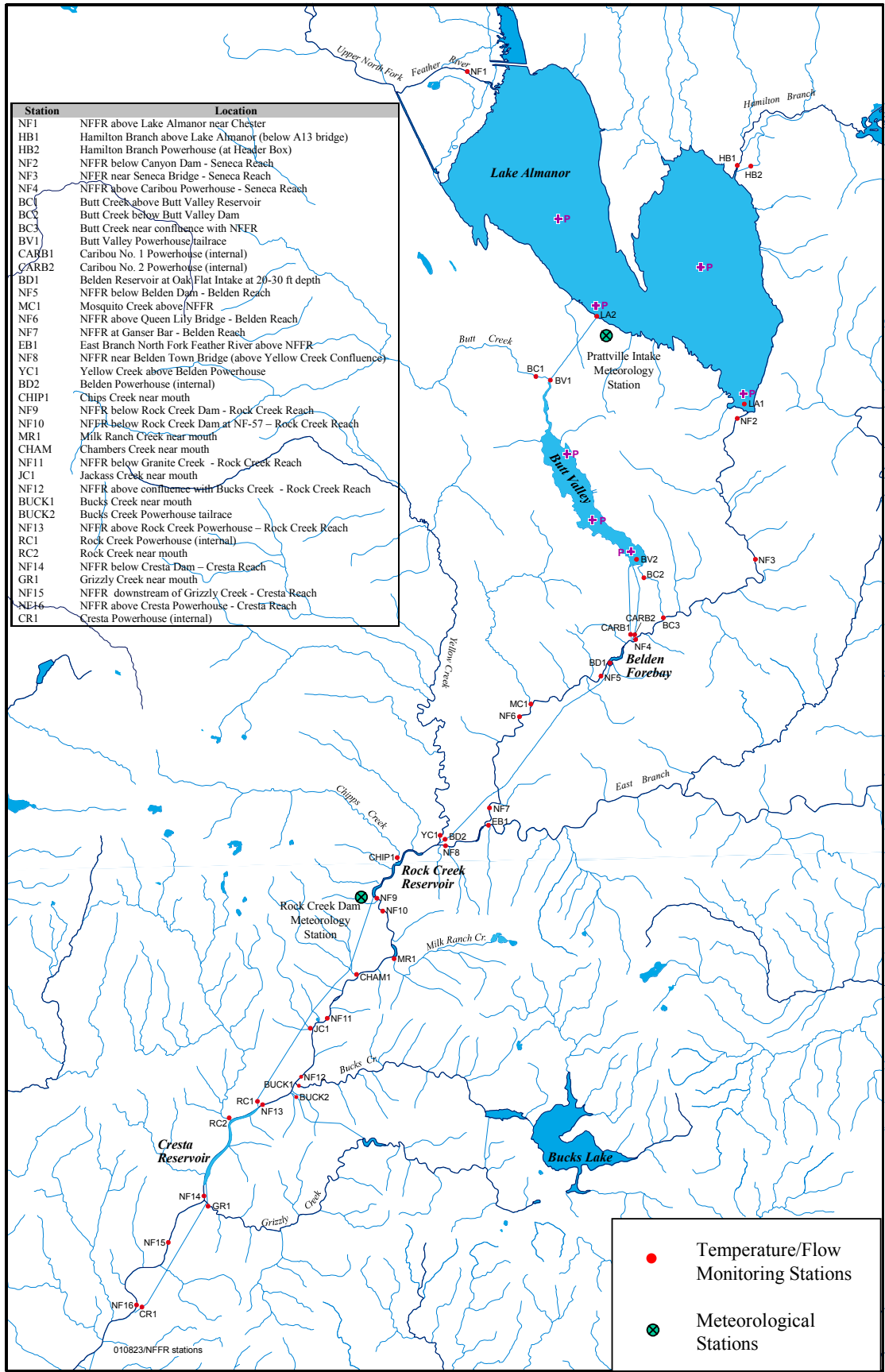
Table 2-1 Physical Characteristics of Reservoirs along the NFFR

Reservoir	Normal Maximum Water Surface Elevation (ft, USGS Datum)	Storage Capacity (acre-ft)	Surface Area at Maximum Water Surface Elevation (acres)	Average Depth (ft)	Maximum Depth (ft)	Hydraulic Residence Time³ (days)
Lake Almanor	4,504	1,142,251	27,000	42	100	265
Butt Valley Reservoir	4,142	49,897	1,600	31	60	10
Belden Reservoir	2,985	2,477	42	59	105	0.5
Rock Creek Reservoir ¹	2,216	4,400	118	37	100	0.7
Cresta Reservoir ²	1,681	4,140	95	44	100	0.5
Poe Reservoir	1,391	1,203	53	23	45	0.2

Notes:

- 1) *Rock Creek Reservoir's original capacity of 4,400 acre-ft has been reduced more than 50% by sedimentation that occurred in the 1980s.*
- 2) *The original capacity of Cresta Reservoir (4,140 acre-ft) has also been decreased by sedimentation.*
- 3) *Hydraulic residence time was estimated based on the powerhouse discharge capacity plus dam release.*

Figure 2-1 NFFR Stream Temperature Monitoring Locations



**Table 2-2a Summary of 2002 - 2004 Mean Daily Water Temperatures
along the NFFR Reaches (°C)**

Station	Month	2002			2003			2004		
		Max	min	mean	max	min	mean	max	min	mean
Belden Reach										
NF5	June	18.9	15.9	17.4	18.2	14.1	16.8	19.1	15.2	17.0
	July	21.1	17.8	19.4	20.8	17.1	18.5	21.6	18.7	20.3
	Aug	21.2	20.2	20.7	20.5	18.4	19.8	21.8	20.8	21.4
	Sep	20.9	16.8	18.8	20.5	17.6	19.0	20.8	17.1	18.8
NF6	June	19.0	15.7	17.1	17.9	14.3	16.6	18.8	15.1	16.9
	July	21.1	18.1	19.5	20.6	17.3	18.5	21.2	18.5	20.0
	Aug	21.1	19.6	20.3	20.3	18.0	19.3	21.4	20.2	20.8
	Sep	20.9	19.3	18.0	19.9	16.7	17.9	20.2	16.1	17.7
NF7	June	19.3	16.2	17.5	18.4	14.9	16.9	19.0	14.7	17.1
	July	21.3	18.5	19.7	20.9	17.3	18.9	21.2	18.5	20.0
	Aug	21.1	19.1	20.1	20.5	17.9	19.3	21.3	19.9	20.5
	Sep	20.5	16.1	17.6	20.0	16.3	17.6	19.9	15.4	17.4
NF8	June	21.2	17.1	19.4	20.5	16.5	18.7	20.8	15.5	18.9
	July	22.9	20.4	21.4	22.9	18.8	21.0	22.9	20.2	21.5
	Aug	22.3	19.5	20.7	22.0	19.2	20.4	22.0	20.1	21.0
	Sep	21.0	16.1	18.0	21.1	16.4	18.2	20.2	15.1	17.6
Rock Creek Reach										
NF10	June	20.7	20.1	20.3	19.1	14.9	17.6	19.9	14.1	17.7
	July	22.5	20.0	21.3	22.1	18.1	19.9	21.9	19.5	20.9
	Aug	22.1	20.5	21.2	21.6	19.9	20.4	21.9	20.6	21.3
	Sep	21.2	17.6	19.1	20.7	17.3	18.8	20.6	16.6	18.5
NF11	June	20.9	16.0	18.6	19.3	14.1	17.1	20.1	14.3	17.8
	July	22.8	20.2	21.5	22.6	17.9	20.2	22.2	19.7	21.1
	Aug	22.5	19.8	21.0	21.7	19.6	20.3	21.9	20.3	21.1
	Sep	21.0	17.3	18.8	20.9	17.0	18.6	20.4	16.3	18.3
NF12	June	21.0	15.9	18.6	19.3	14.2	17.2	20.2	14.4	17.9
	July	22.9	20.2	21.6	22.7	17.8	20.3	22.3	19.8	21.2
	Aug	22.6	19.7	21.0	21.8	19.6	20.3	22.0	20.4	21.2
	Sep	21.1	17.2	18.8	21.0	16.8	18.6	20.5	16.3	18.3
NF13	June	21.0	15.8	18.6	17.9	13.3	15.7	19.3	13.3	16.5
	July	22.8	19.4	20.7	23.0	15.4	18.7	21.1	18.6	19.5
	Aug	21.8	17.6	19.3	22.0	16.3	18.4	19.0	17.3	18.1
	Sep	18.1	15.0	16.3	17.1	14.2	15.6	19.2	15.7	17.2
Cresta Reach										
NF14	June	20.8	16.7	18.4	18.5	14.1	16.9	19.8	14.0	17.2
	July	22.2	20.3	21.2	22.2	17.4	19.6	21.6	19.4	20.7
	Aug	21.9	19.6	20.7	21.8	19.2	20.0	21.3	20.0	20.6
	Sep	20.5	17.1	18.5	20.1	16.8	18.2	20.0	16.5	18.3
NF15	June	20.9	16.2	18.4	18.6	14.0	16.9	19.7	14.3	17.3
	July	22.1	20.4	21.3	22.4	17.3	19.8	21.7	19.4	20.7
	Aug	22.0	19.5	20.6	21.9	19.3	20.0	21.3	19.9	20.6
	Sep	20.5	16.9	18.4	20.3	16.7	18.2	19.9	16.3	18.1
NF16	June	21.2	16.4	18.7	18.9	14.4	17.2	20.0	14.7	17.6
	July	22.6	20.9	21.7	22.7	17.7	20.1	22.1	19.7	21.1
	Aug	22.4	19.6	20.9	22.1	19.5	20.2	21.6	20.2	20.9
	Sep	20.7	17.1	18.5	20.6	16.5	18.3	20.2	16.5	18.3

**Table 2-2a Summary of 2002 - 2004 Mean Daily Water Temperatures
along the NFFR Reaches (°C) (Continued)**

Station	Month	2002			2003			2004		
		Max	min	mean	Max	min	mean	max	min	mean
Poe Reach										
NF17	June	21.0	16.7	18.7	18.7	14.1	17.0	20.0	14.5	17.5
	July	22.5	20.7	21.6	22.5	17.6	19.9	21.9	19.7	21.0
	Aug	22.3	20.1	21.0	22.2	19.5	20.3	21.5	20.2	20.9
	Sep	20.7	17.5	18.8	20.2	17.0	18.4	20.3	18.4	19.6
NF18	June	23.2	17.8	21.0	21.0	17.6	19.7	22.4	17.5	20.1
	July	24.7	22.9	23.7	24.5	19.6	22.1	24.4	21.4	22.9
	Aug	24.1	20.9	22.3	23.5	20.5	21.5	22.9	21.1	22.1
	Sep	22.1	18.6	19.6	21.9	17.0	19.2	21.2	18.7	20.2

Notes:

- 1) *All values are mean daily water temperatures computed from hourly temperature measurements. Monthly statistics represent the maximum, minimum, and mean daily water temperatures based on the hourly temperature measurements. For example, the maximum June temperature represents the maximum mean daily temperature measured in June.*
- 2) *Refer to Figure 2-1 for station locations.*
- 3) *NF17: NFFR below Poe Dam.*
- 4) *NF18: NFFR above Poe PH.*

**Table 2-2b Summary of 2002 - 2004 Mean Daily Water Temperatures
at the NFFR Powerhouse Discharges (°C)**

Powerhouse	Month	2002			2003			2004		
		Max	Min	Mean	Max	Min	Mean	Max	Min	Mean
Butt Valley PH	June	16.1	14.8	15.5	16.3	11.7	14.1	18.7	14.7	17.4
	July	21.7	17.8	20.2	19.1	15.4	17.4	21.3	18.4	19.7
	Aug	21.9	20.4	21.2	20.4	19.3	19.8	21.8	20.2	21.1
	Sep	21.3	17.9	19.3	20.6	17.8	18.9	20.3	16.8	18.6
Caribou #1 PH	June	13.3	12.3	12.7	11.2	10.9	11.0	18.0	16.4	17.2
	July	21.0	16.3	19.3	19.1	16.4	18.1	21.1	18.0	19.9
	Aug	21.9	21.2	21.4	20.0	17.5	19.5	21.7	20.8	21.2
	Sep	21.3	18.2	19.7	20.1	18.0	19.1	20.8	16.8	19.1
Caribou #2 PH	June	21.5	17.4	19.3	19.3	16.7	18.2	21.0	17.7	19.6
	July	24.0	21.9	23.2	23.4	18.4	20.4	22.7	21.0	22.0
	Aug	23.7	21.5	22.5	21.9	21.0	21.4	22.7	21.4	22.1
	Sep	22.1	18.3	19.9	21.8	19.2	20.2	21.4	17.4	19.4
Belden PH	June	18.7	17.7	18.0	19.2	15.6	18.1	20.0	16.6	18.8
	July	22.5	19.0	21.2	21.7	17.4	19.3	22.0	19.4	20.9
	Aug	22.6	21.4	21.8	21.1	20.3	20.7	22.2	21.1	21.7
	Sep	21.7	18.3	19.8	21.1	18.2	19.5	21.1	17.3	19.2
Rock Creek PH	June	20.1	16.1	18.1	19.6	14.8	17.7	20.1	14.3	17.8
	July	22.6	19.6	21.3	22.3	18.5	20.1	22.3	19.8	21.3
	Aug	22.6	21.0	21.7	22.0	20.4	20.9	22.5	21.4	21.9
	Sep	21.7	18.4	19.8	21.2	18.1	19.5	21.4	17.4	19.7
Cresta PH	June	20.8	16.3	18.5	18.5	13.9	16.8	19.8	13.8	17.1
	July	22.5	20.4	21.4	22.3	17.4	19.7	21.5	19.4	20.7
	Aug	22.5	20.1	21.0	22.0	19.5	20.2	21.2	20.1	20.7
	Sep	20.7	17.3	18.7	20.1	17.0	18.3	20.1	16.7	18.5

Table 2-3a Summary of 2002 - 2004 Mean Daily Water Temperature Comparison with the 20°C Level along the NFFR Reaches

Station	Month	2002			2003			2004		
		Days Greater than 20°C	Total Data Days	Percent Greater than 20°C	Days Greater than 20°C	Total Data Days	Percent Greater than 20°C	Days Greater than 20°C	Total Data Days	Percent Greater than 20°C
Belden Reach										
NF5	June	0	30	0%	0	30	0%	0	30	0%
	July	7	31	23%	4	31	13%	18	31	58%
	Aug	31	31	100%	10	31	32%	31	31	100%
	Sep	6	30	20%	6	30	20%	4	30	13%
NF6	June	0	30	0%	0	30	0%	0	30	0%
	July	7	31	23%	4	31	13%	17	31	55%
	Aug	23	31	74%	1	31	3%	31	31	100%
	Sep	2	30	7%	0	30	0%	1	30	3%
NF7	June	0	30	0%	0	30	0%	0	30	0%
	July	13	31	42%	4	31	13%	19	31	61%
	Aug	18	31	58%	2	31	6%	28	31	90%
	Sep	2	30	7%	1	30	3%	0	30	0%
NF8	June	8	30	27%	4	30	13%	10	30	33%
	July	31	31	100%	22	31	71%	31	31	100%
	Aug	23	31	74%	23	31	74%	31	31	100%
	Sep	3	30	10%	6	30	20%	1	30	3%
Rock Creek Reach										
NF10	June	5	5	100%	0	30	0%	0	30	0%
	July	29	31	94%	13	31	42%	26	31	84%
	Aug	31	31	100%	27	31	87%	31	31	100%
	Sep	5	30	17%	6	30	20%	2	30	7%
NF11	June	6	30	20%	0	30	0%	3	30	10%
	July	31	31	100%	20	31	65%	28	31	90%
	Aug	29	31	94%	22	31	71%	31	31	100%
	Sep	4	30	13%	6	30	20%	2	30	7%
NF12	June	6	30	20%	0	30	0%	4	30	13%
	July	31	31	100%	20	31	65%	29	31	94%
	Aug	28	31	90%	21	31	68%	31	31	100%
	Sep	4	30	13%	6	30	20%	2	30	7%
NF13	June	6	30	20%	0	30	0%	0	30	0%
	July	26	31	84%	4	31	13%	6	31	19%
	Aug	10	31	32%	7	31	23%	0	31	0%
	Sep	0	30	0%	0	30	0%	0	30	0%
Cresta Reach										
NF14	June	4	30	13%	0	30	0%	0	30	0%
	July	31	31	100%	10	31	32%	24	31	77%
	Aug	27	31	87%	11	31	35%	30	31	97%
	Sep	4	30	13%	2	30	7%	0	30	0%
NF15	June	5	30	17%	0	30	0%	0	30	0%
	July	31	31	100%	14	31	45%	24	31	77%
	Aug	26	30	84%	12	31	39%	29	31	94%
	Sep	4	30	13%	4	30	13%	0	30	0%
NF16	June	6	30	20%	0	30	0%	1	30	3%
	July	31	31	100%	17	31	55%	28	31	90%
	Aug	28	31	90%	14	31	45%	31	31	100%
	Sep	4	30	13%	5	30	17%	2	30	7%

Table 2-3a Summary of 2002 - 2004 Mean Daily Water Temperature Comparison with the 20°C Level along the NFFR Reaches (Continued)

Station	Month	2002			2003			2004		
		Days Greater than 20°C	Total Data Days	Percent Greater than 20°C	Days Greater than 20°C	Total Data Days	Percent Greater than 20°C	Days Greater than 20°C	Total Data Days	Percent Greater than 20°C
Poe Reach										
NF17	June	5	30	17%	0	30	0%	1	30	3%
	July	31	31	100%	15	31	48%	29	31	94%
	Aug	31	31	100%	19	31	61%	31	31	100%
	Sep	4	27	15%	5	30	17%	2	15	13%
NF18	June	24	30	80%	12	30	40%	15	30	50%
	July	31	31	100%	28	31	90%	31	31	100%
	Aug	31	31	100%	31	31	100%	31	31	100%
	Sep	4	26	15%	7	30	23%	9	15	60%

Notes:

- 1) Refer to Figure 2-1 for station locations
- 2) NF17: NFFR below Poe Dam.
- 3) NF18: NFFR above Poe PH.

Table 2-3b Summary of 2002 - 2004 Mean Daily Water Temperature Comparison with the 20°C Level at the NFFR Powerhouse Discharges

Powerhouse	Month	2002			2003			2004		
		Days Greater than 20°C	Total Data Days	Percent Greater than 20°C	Days Greater than 20°C	Total Data Days	Percent Greater than 20°C	Days Greater than 20°C	Total Data Days	Percent Greater than 20°C
Butt Valley PH	June	0	4	0%	0	28	0%	0	22	0%
	July	20	29	69%	0	31	0%	13	31	42%
	Aug	31	31	100%	9	31	29%	31	31	100%
	Sep	5	30	17%	5	27	19%	3	30	10%
Caribou #1 PH	June	0	5	0%	0	2	0%	0	2	0%
	July	10	29	34%	0	14	0%	15	31	48%
	Aug	31	31	100%	0	31	0%	31	31	100%
	Sep	8	31	27%	4	25	16%	6	21	29%
Caribou #2 PH	June	8	30	27%	0	30	0%	14	30	47%
	July	28	28	100%	13	24	54%	26	26	100%
	Aug	31	31	100%	31	31	100%	31	31	100%
	Sep	13	30	43%	14	30	47%	13	30	43%
Belden PH	June	0	7	0%	0	30	0%	0	20	0%
	July	25	29	86%	9	31	29%	26	31	84%
	Aug	31	31	100%	31	31	100%	31	31	100%
	Sep	NA	NA	NA	10	30	33%	10	30	33%
Rock Creek PH	June	1	30	3%	0	30	0%	3	30	10%
	July	29	31	94%	17	31	55%	29	31	94%
	Aug	31	31	100%	31	31	100%	31	31	100%
	Sep	11	30	37%	10	30	33%	18	30	60%
Cresta PH	June	5	30	17%	0	30	0%	0	30	0%
	July	30	30	100%	13	31	42%	24	31	77%
	Aug	31	31	100%	16	31	52%	31	31	100%
	Sep	5	30	17%	2	30	7%	2	30	7%

Table 2-4 Summary of Observed Mean Daily Water Temperatures during July 2003 Caribou Special Test

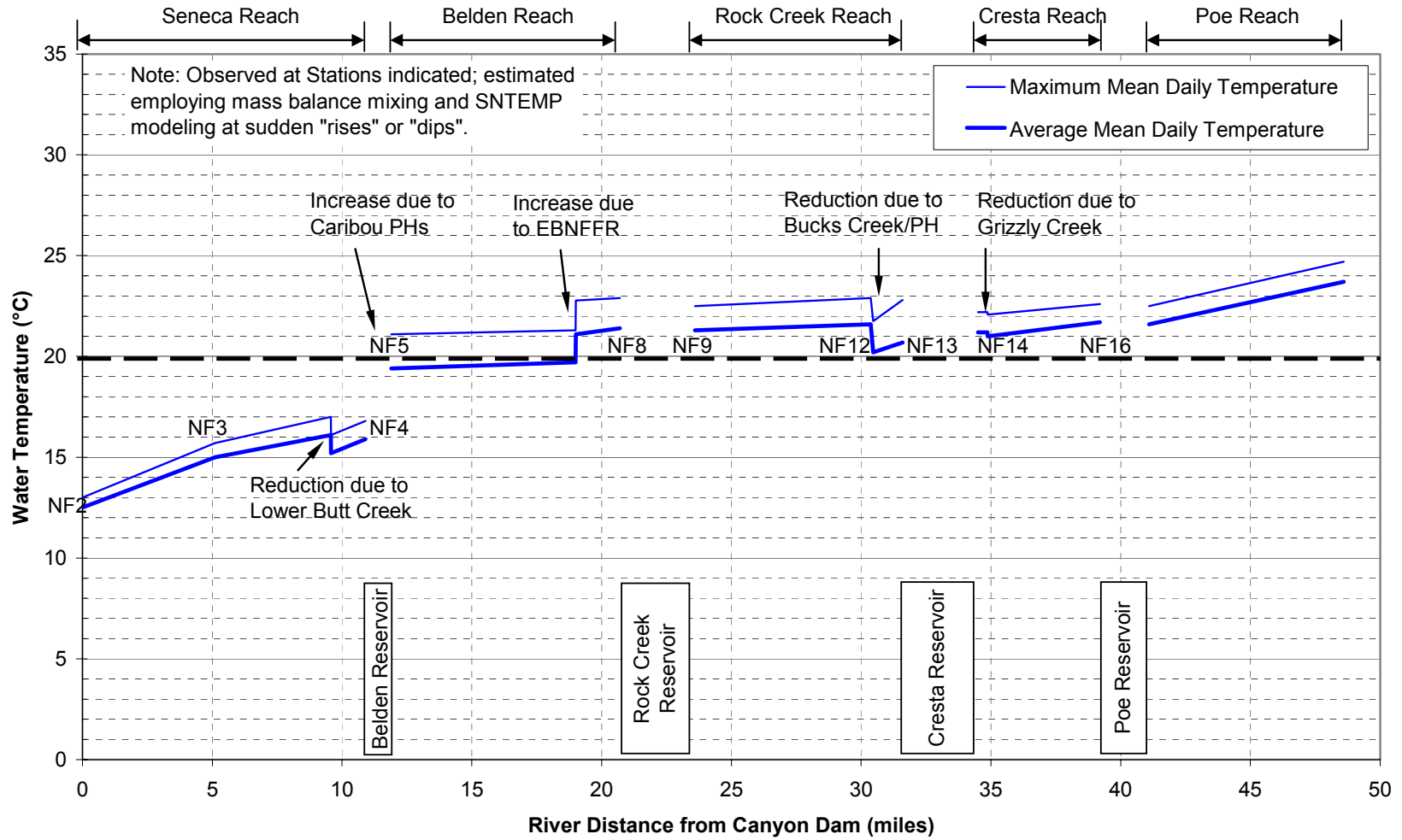
Date	Caribou No. 1		Caribou No. 2		Resultant Caribou Blend *	Belden Forebay (BD1) (°C)	NFFR below Belden Dam (NF5) (°C)	NFFR above EBNFFR (NF7) (°C)	EBNFFR above NFFR (EB1) (°C)	NFFR above Belden PH (NF8) (°C)	Remarks
	Temperature (°C)	Flow (cfs)	Temperature (°C)	Flow (cfs)							
	07/12/03	---	9	20.1							
07/13/03	---	7	20.0	1172	20.0	19.8	19.0	18.9	22.4	20.7	Part 1
07/14/03	---	0	20.2	1214	20.2	19.8	19.2	19.1	22.3	20.7	Part 1
07/15/03	---	14	20.5	1270	20.5	20.1	19.4	19.3	22.5	20.9	Part 1
07/16/03	---	57	20.6	1191	20.6	20.2	19.4	19.4	22.7	21.1	Part 1
07/17/03	---	66	21.0	1250	21.0	20.3	19.6	19.5	22.8	21.1	Part 1
07/18/03	16.4	893	---	67	16.4	19.1	18.3	19.1	23.2	21.3	Part 2
07/19/03	16.8	940	---	21	16.8	17.5	17.2	18.6	23.8	21.2	Part 2
07/20/03	17.0	994	---	12	17.0	17.3	17.1	18.5	24.4	21.4	Part 2
07/21/03	17.5	996	---	0	17.5	17.6	17.2	18.8	25.4	22.0	Part 2
07/22/03	17.8	996	---	0	17.8	17.8	17.4	19.0	25.8	22.1	Part 2
07/23/03	18.0	997	---	9	18.0	18.1	17.6	19.0	26.4	22.3	Part 2
07/24/03	18.4	992	---	3	18.4	18.4	17.8	19.0	25.8	22.0	Part 2
07/25/03	18.4	564	---	3	18.4	19.8	18.1	19.0	25.1	21.8	Part 2
07/26/03	18.4	628	23.0	897	21.1	20.9	18.5	19.1	24.7	21.6	Part 3
07/27/03	18.8	495	23.0	1001	21.6	21.3	19.4	19.6	24.5	21.7	Part 3
07/28/03	19.1	495	23.0	842	21.5	21.4	20.0	20.4	24.9	22.4	Part 3
07/29/03	19.0	552	23.4	904	21.7	21.5	20.1	20.6	25.4	22.9	Part 3
07/30/03	19.1	460	23.2	874	21.8	21.7	20.5	20.7	25.6	23.0	Part 3

* Based on mass balance calculations.

Table 2-4 Summary of Observed Water Temperatures during July 2003 Caribou Special Test (Continued)

Date	Belden PH		NFFR below Rock Creek Dam	NFFR Above Bucks Creek	NFFR above Rock Creek PH	NFFR below Cresta Dam	NFFR above Cresta PH	NFFR below Poe Dam	NFFR above Poe PH	Remarks
	Temperature (°C)	Flow (cfs)	(NF9) (°C)	(NF12) (°C)	(NF13) (°C)	(NF14) (°C)	(NF16) (°C)	(°C)	(°C)	
	07/12/03	19.6	984	19.8	20.1	18.2	19.4	19.8	19.6	
07/13/03	19.8	1086	19.9	20.2	18.2	19.5	20.0	19.9	21.9	Part 1
07/14/03	19.8	1172	19.8	20.0	18.1	19.6	19.9	19.9	21.9	Part 1
07/15/03	20.1	1140	20.1	20.3	18.3	19.7	20.1	19.9	22.0	Part 1
07/16/03	20.2	1221	20.2	20.5	18.4	19.9	20.2	20.2	22.1	Part 1
07/17/03	20.3	1199	20.2	20.5	18.4	19.9	20.3	20.3	22.1	Part 1
07/18/03	19.5	900	20.4	20.7	18.5	20.0	20.4	20.3	22.3	Part 2
07/19/03	17.8	913	19.7	21.1	18.8	20.2	20.8	20.5	22.7	Part 2
07/20/03	17.4	903	19.1	21.0	18.7	19.6	20.6	20.2	22.7	Part 2
07/21/03	17.6	957	19.3	21.3	19.0	19.6	20.9	20.0	23.4	Part 2
07/22/03	17.9	962	19.6	21.5	19.2	19.8	21.0	20.1	23.6	Part 2
07/23/03	18.2	944	19.9	21.7	19.3	20.1	21.2	20.4	23.9	Part 2
07/24/03	18.4	932	19.8	21.4	19.1	20.1	21.2	20.5	23.6	Part 2
07/25/03	19.5	1352	19.9	21.1	18.8	19.9	21.0	20.3	23.3	Part 2
07/26/03	20.8	1441	20.7	21.1	18.8	20.1	20.5	20.4	23.1	Part 3
07/27/03	21.3	1323	21.2	21.2	19.8	20.6	21.0	20.8	22.8	Part 3
07/28/03	21.4	1318	21.5	21.8	20.5	21.4	21.7	21.4	23.2	Part 3
07/29/03	21.5	1413	21.7	22.4	22.3	21.7	22.2	22.0	23.9	Part 3
07/30/03	21.7	1361	22.0	22.7	23.0	22.1	22.7	22.4	24.5	Part 3

**Figure 2-2 Observed and Estimated July 2002 (Dry Year) Water Temperature Profile along NFFR
(Observed Average Mean Daily Temperature at BD1 (Belden Forebay) = 21.5°C)**



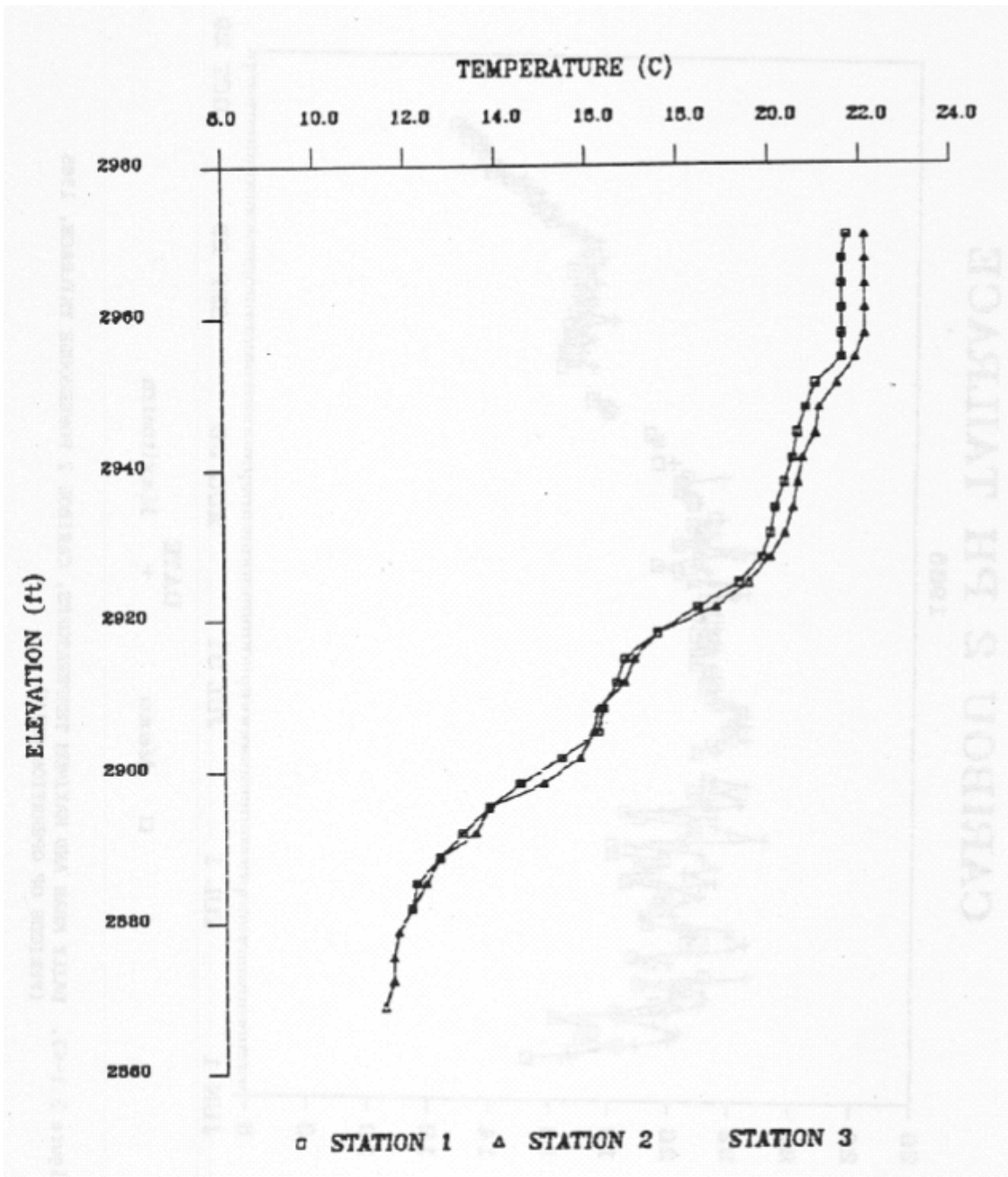


Figure 2-3a Belden Reservoir Temperature Profiles, June 21, 1985
 (Source: Woodward-Clyde Consultants, 1986)

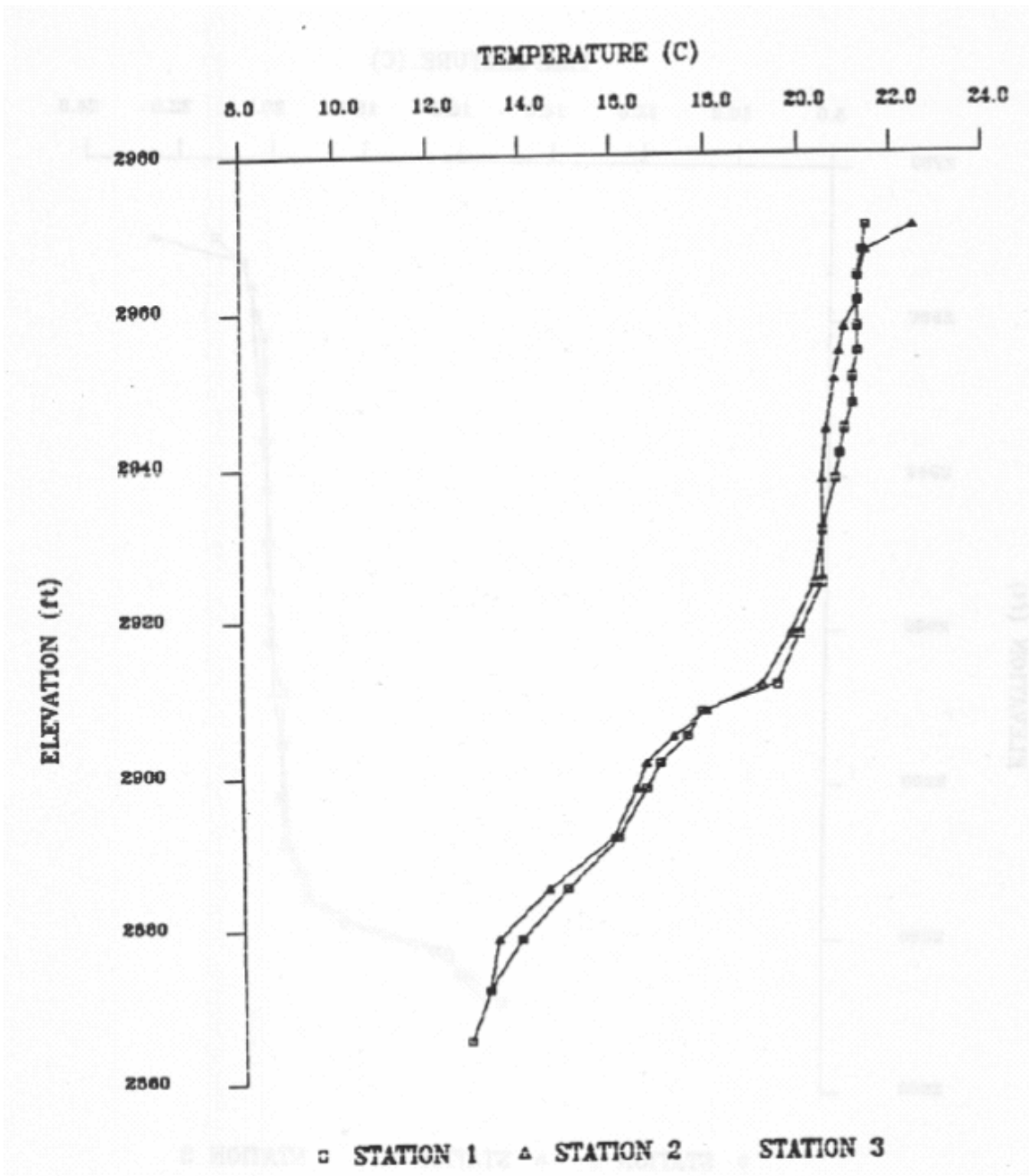


Figure 2-3b Belden Reservoir Temperature Profiles, July 12, 1985
 (Source: Woodward-Clyde Consultants, 1986)

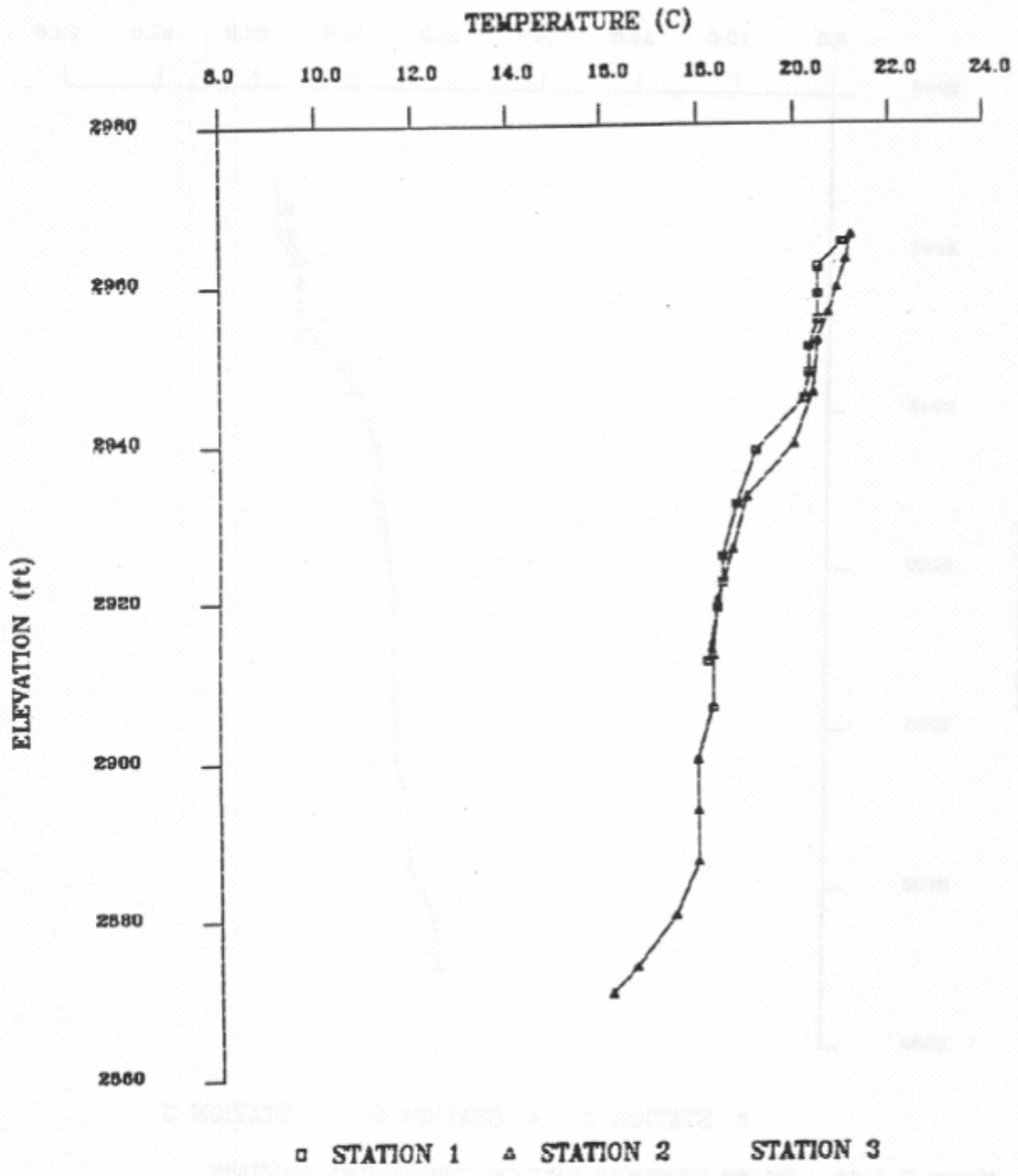


Figure 2-3c Belden Reservoir Temperature Profiles, August 20, 1985
 (Source: Woodward-Clyde Consultants, 1986)

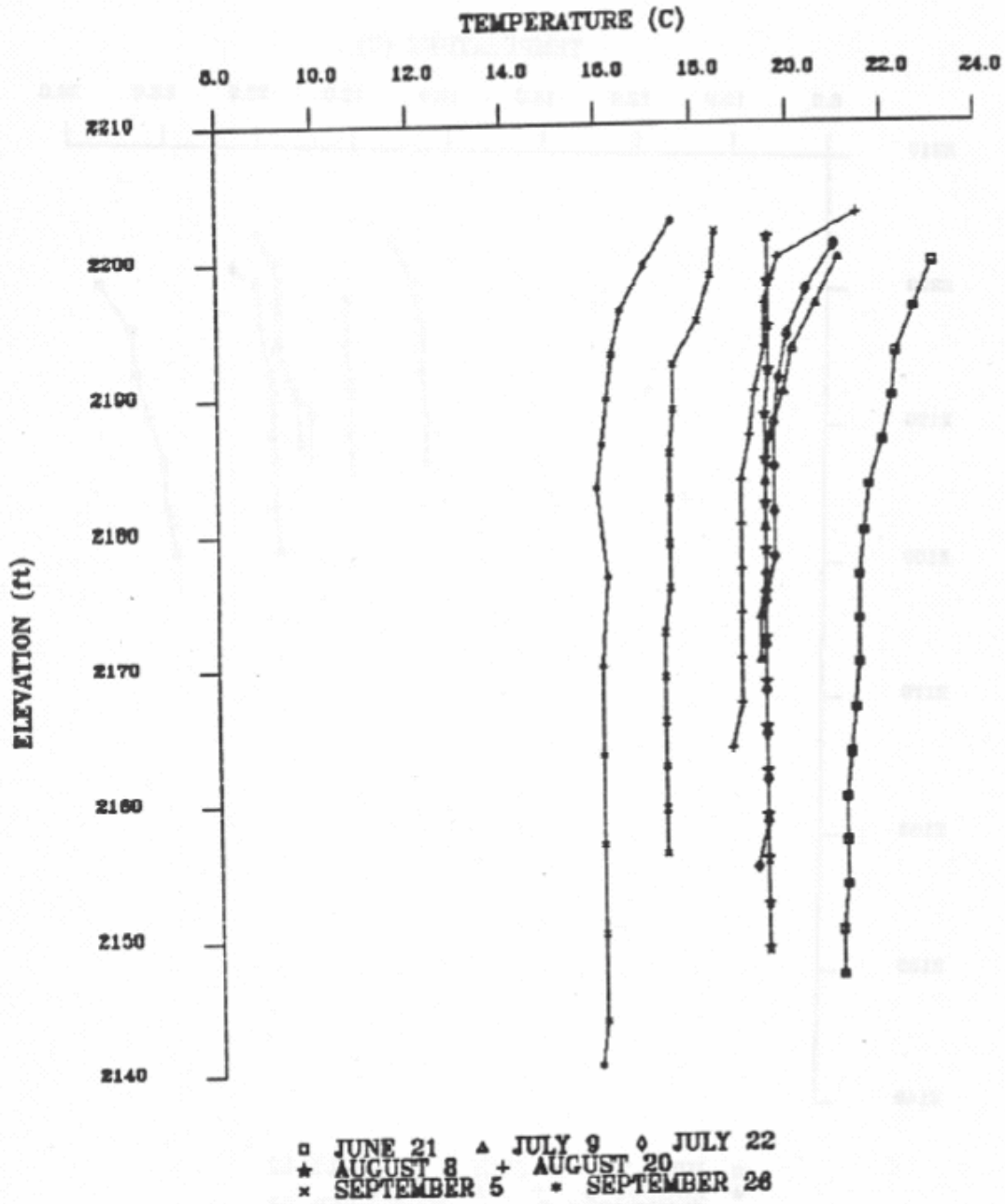


Figure 2-4 Rock Creek Reservoir Temperature Profiles near Rock Creek Dam, 1985
 (Source: Woodward-Clyde Consultants, 1986)

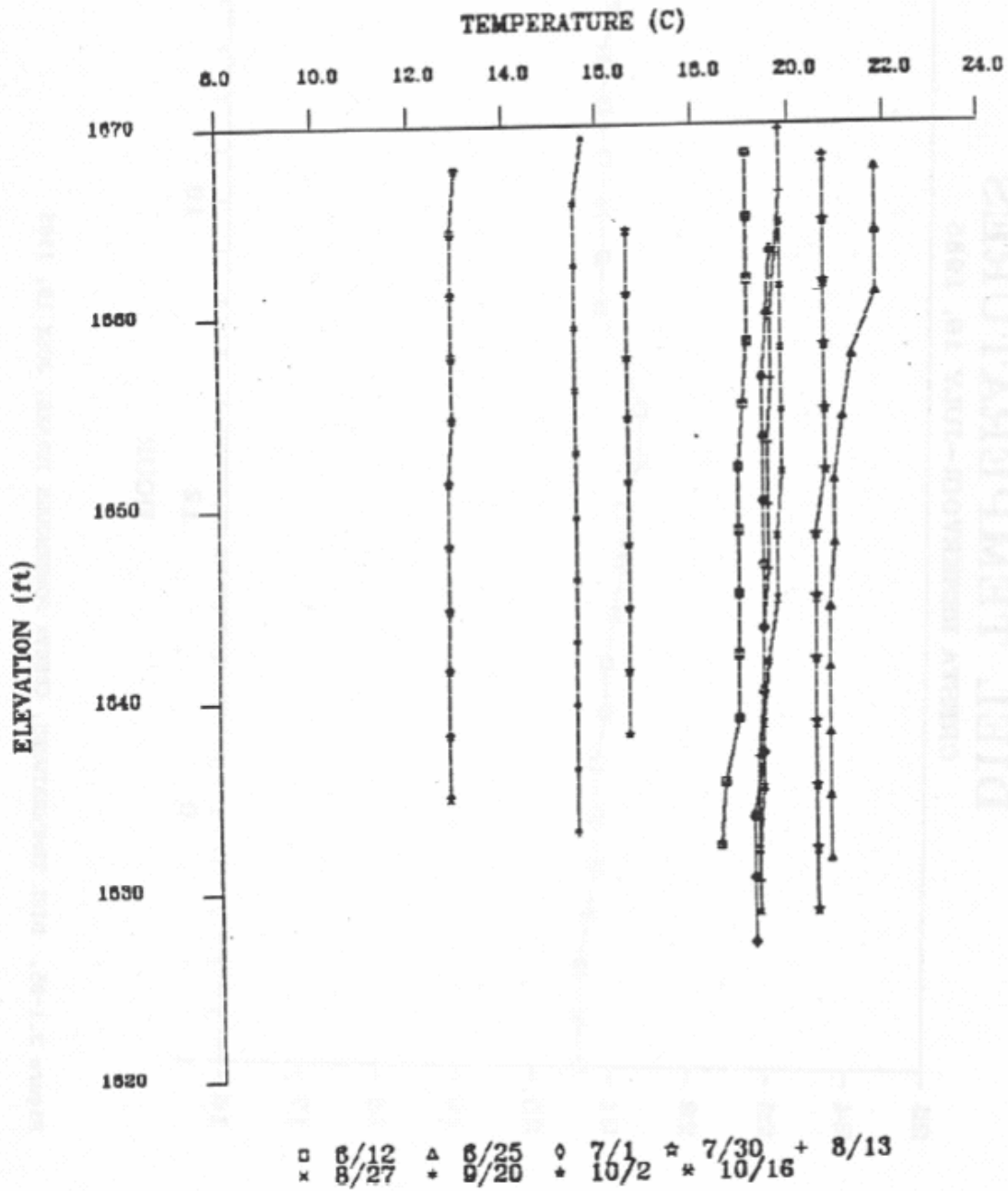


Figure 2-5 Cresta Reservoir Temperature Profiles near Cresta Dam, 1985
 (Source: Woodward-Clyde Consultants, 1986)

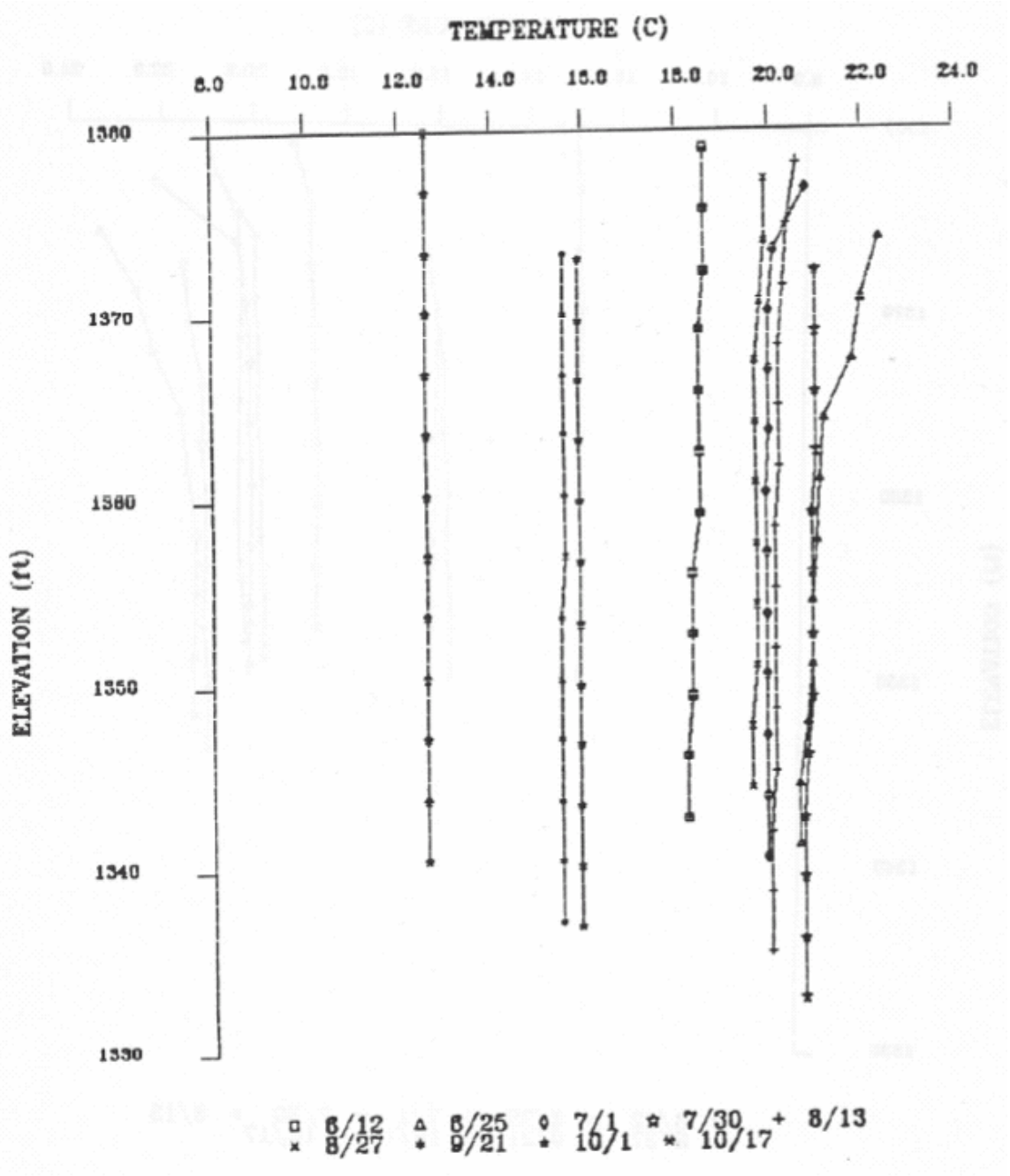


Figure 2-6 Poe Reservoir Temperature Profiles near Poe Dam, 1985
 (Source: Woodward-Clyde Consultants, 1986)

Figure 2-7 Hourly Inflows to Belden Reservoir on 7/21 - 7/ 31, 2002

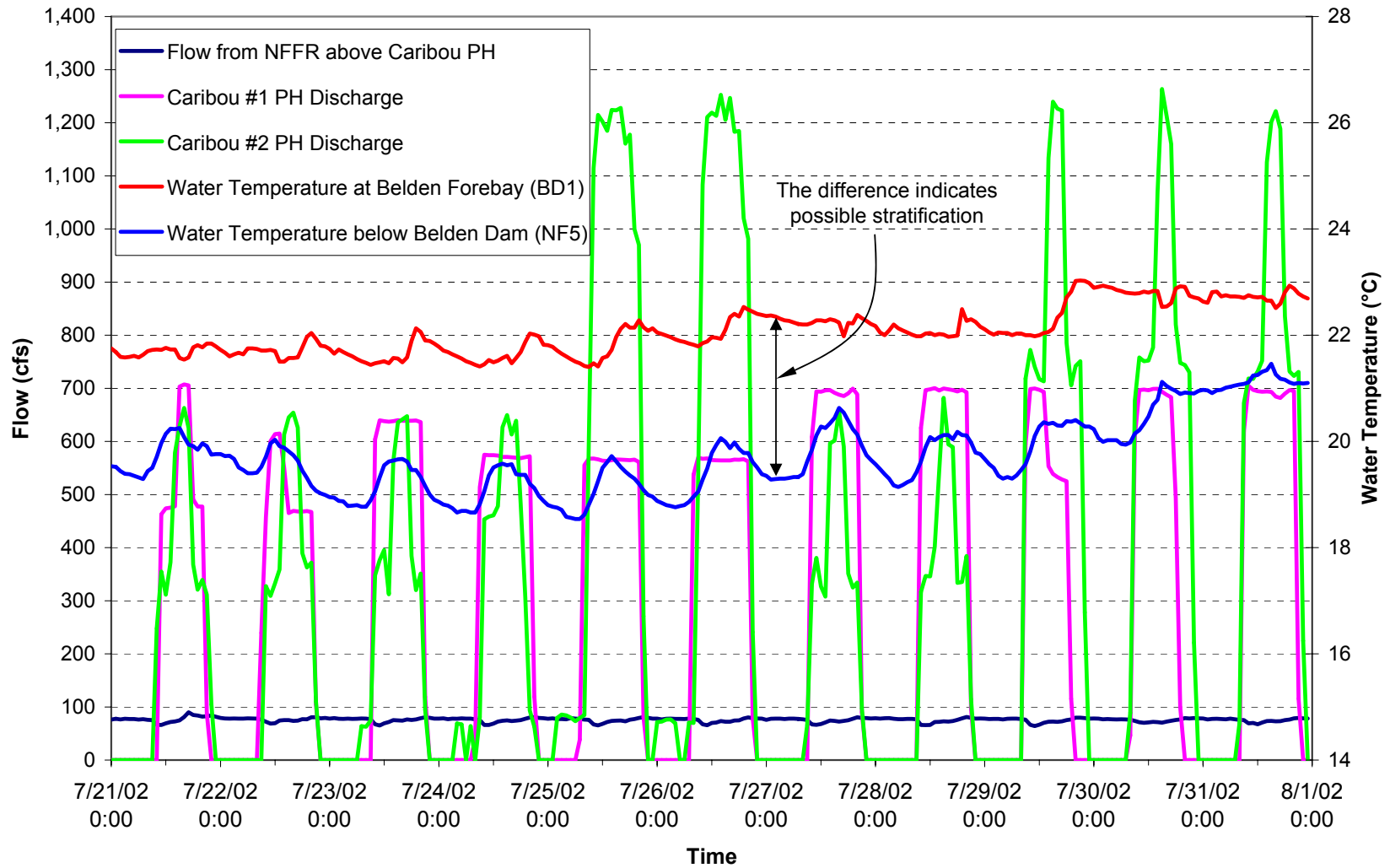


Figure 2-8 Hourly Inflows to Rock Creek Reservoir on 7/21 - 7/31, 2002

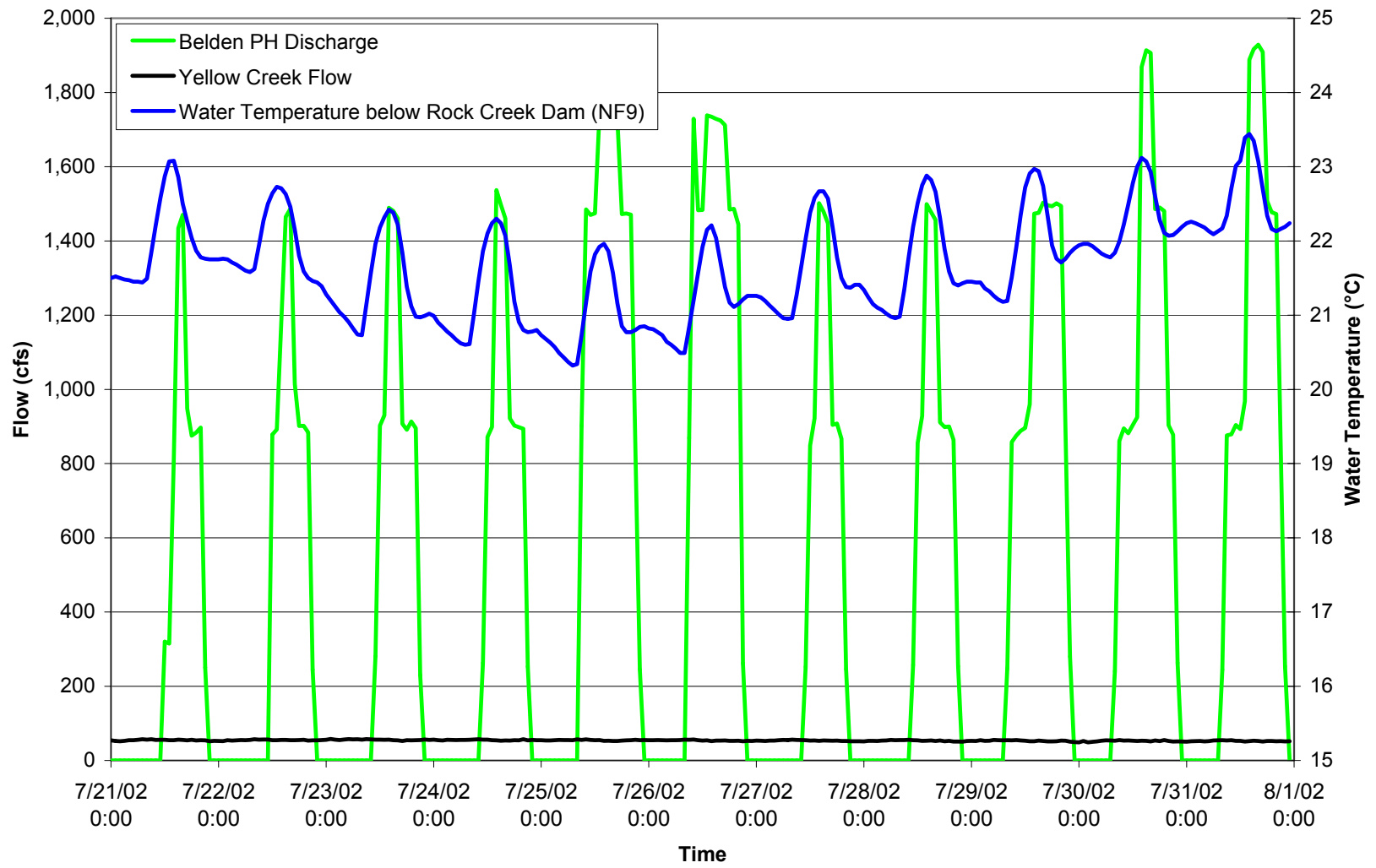


Figure 2-9 Observed Mean Daily Temperatures along NFFR during July 2003 Caribou Special Test

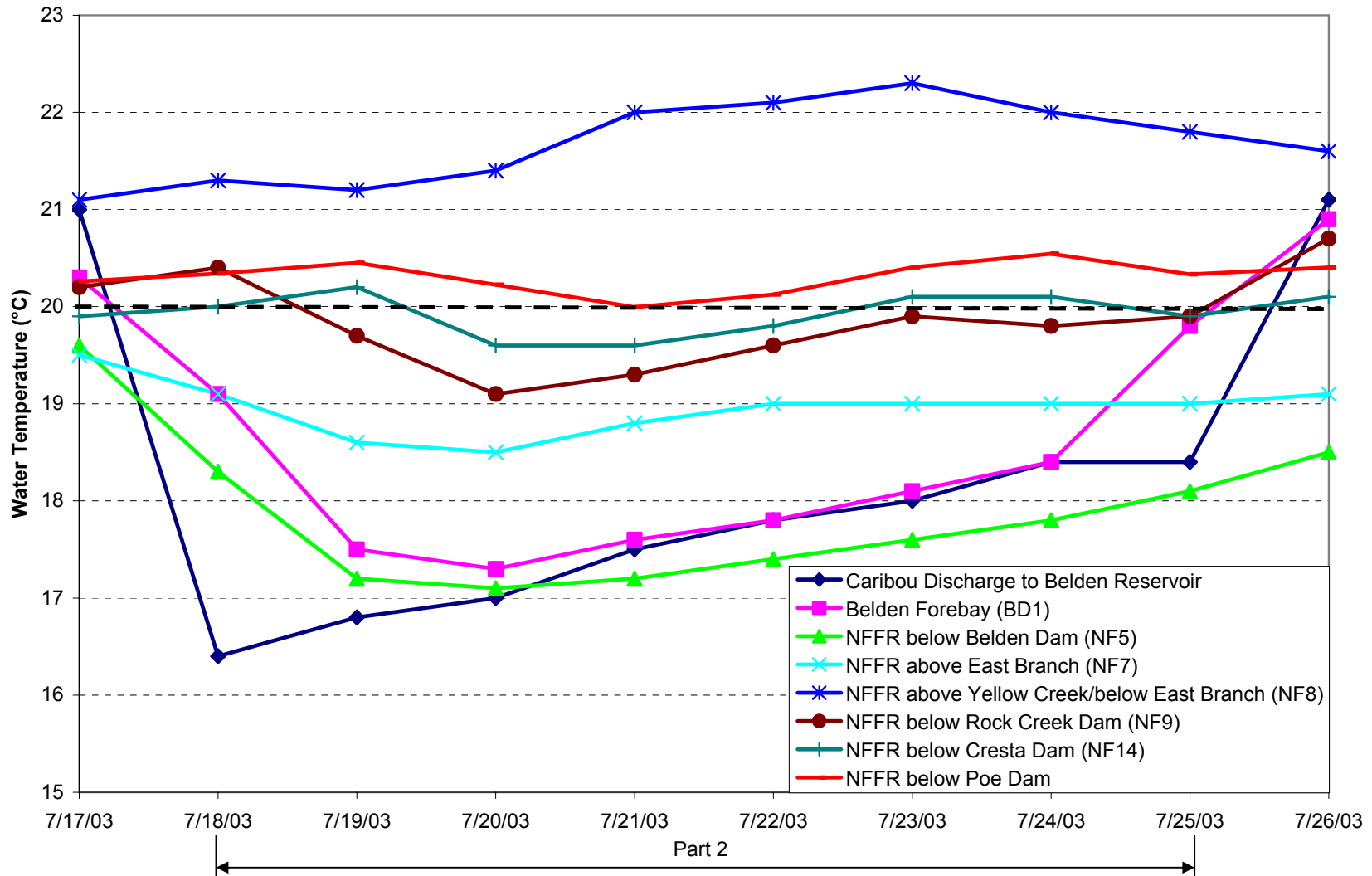


Figure 2-10 Observed Mean Daily Temperatures Indicating Possible Belden Reservoir Stratification during July 2003 Caribou Special Test

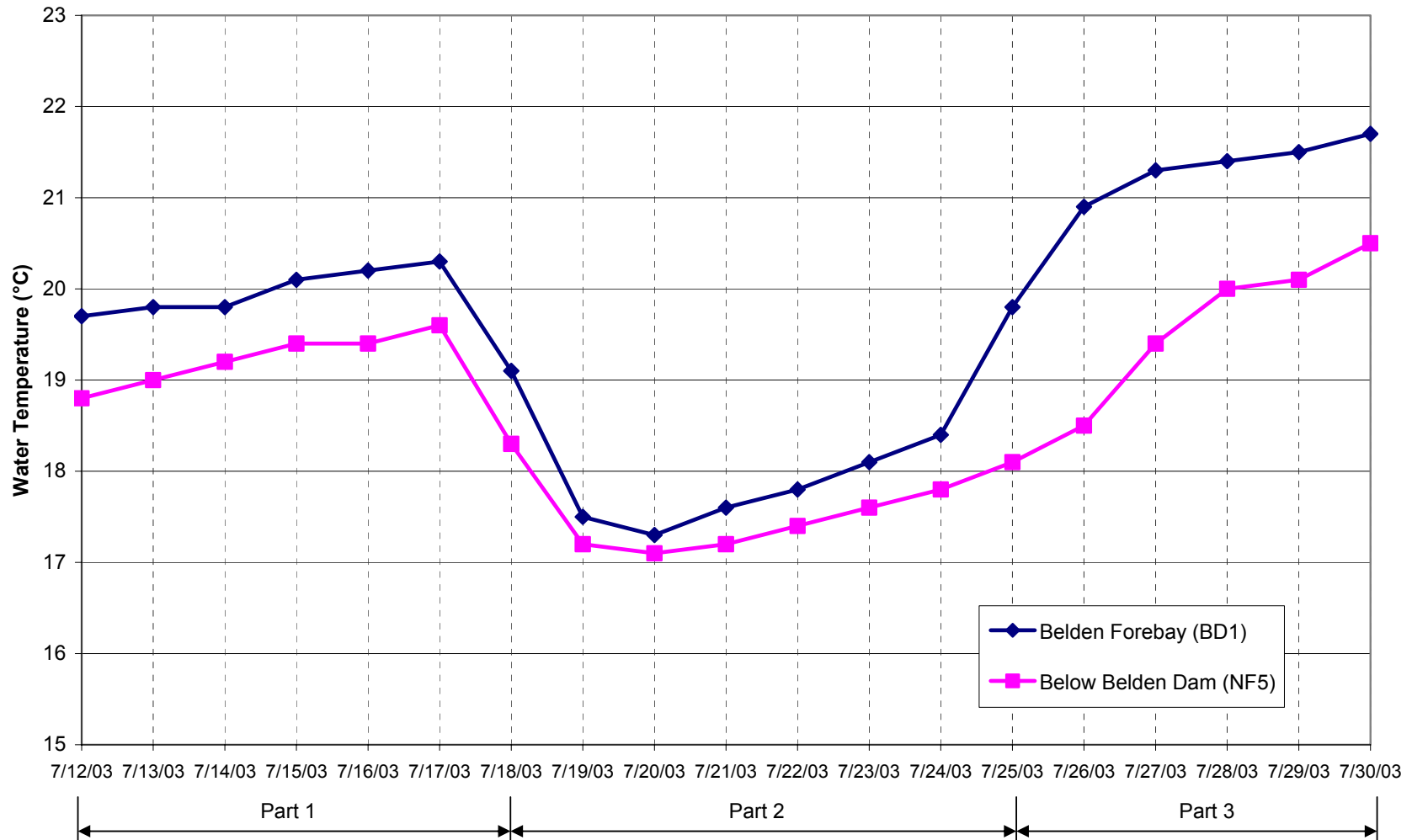


Figure 2-11 Observed Mean Daily Temperatures Indicating Possible Rock Creek Reservoir Warming during July 2003 Caribou Special Test

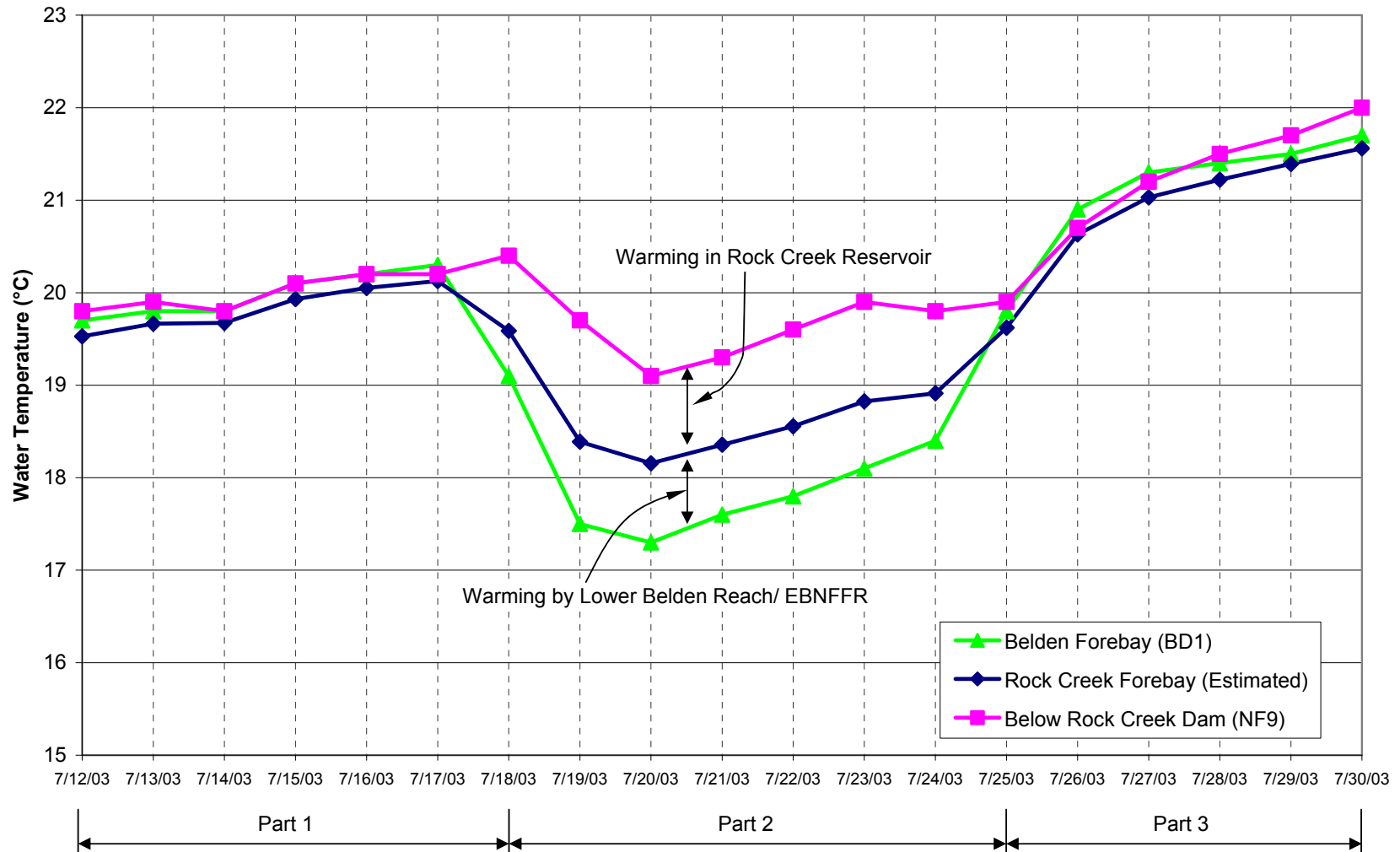
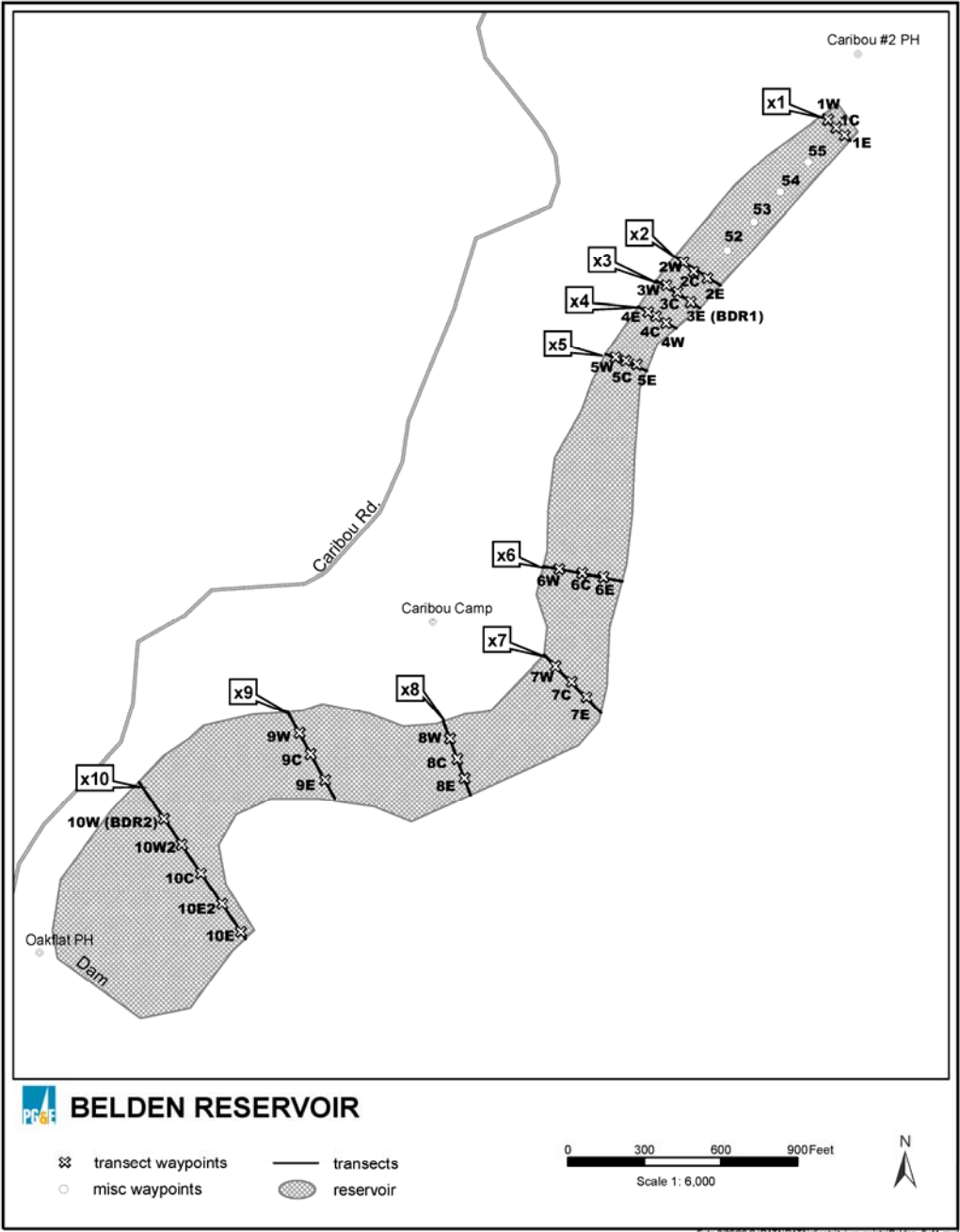


Figure 2-12 Belden Reservoir Water Temperature Profile Monitoring Sites and Current Velocity Transects during Summer 2006 Special Test



Exit 9/30/06 C:\DATA\GIS\Belden\waypoints\Belden_bx11.mxd

**Figure 2-13 Belden Reservoir Temperature Profiles along the Centerline of the Upper Portion of the Reservoir during Summer 2006 Special Test (Caribou #2 was shutdown; Caribou #1 was operating at 527 cfs)
July 22, 2006, 11:00 am
(Refer to Figure 2-12 for monitoring locations)**

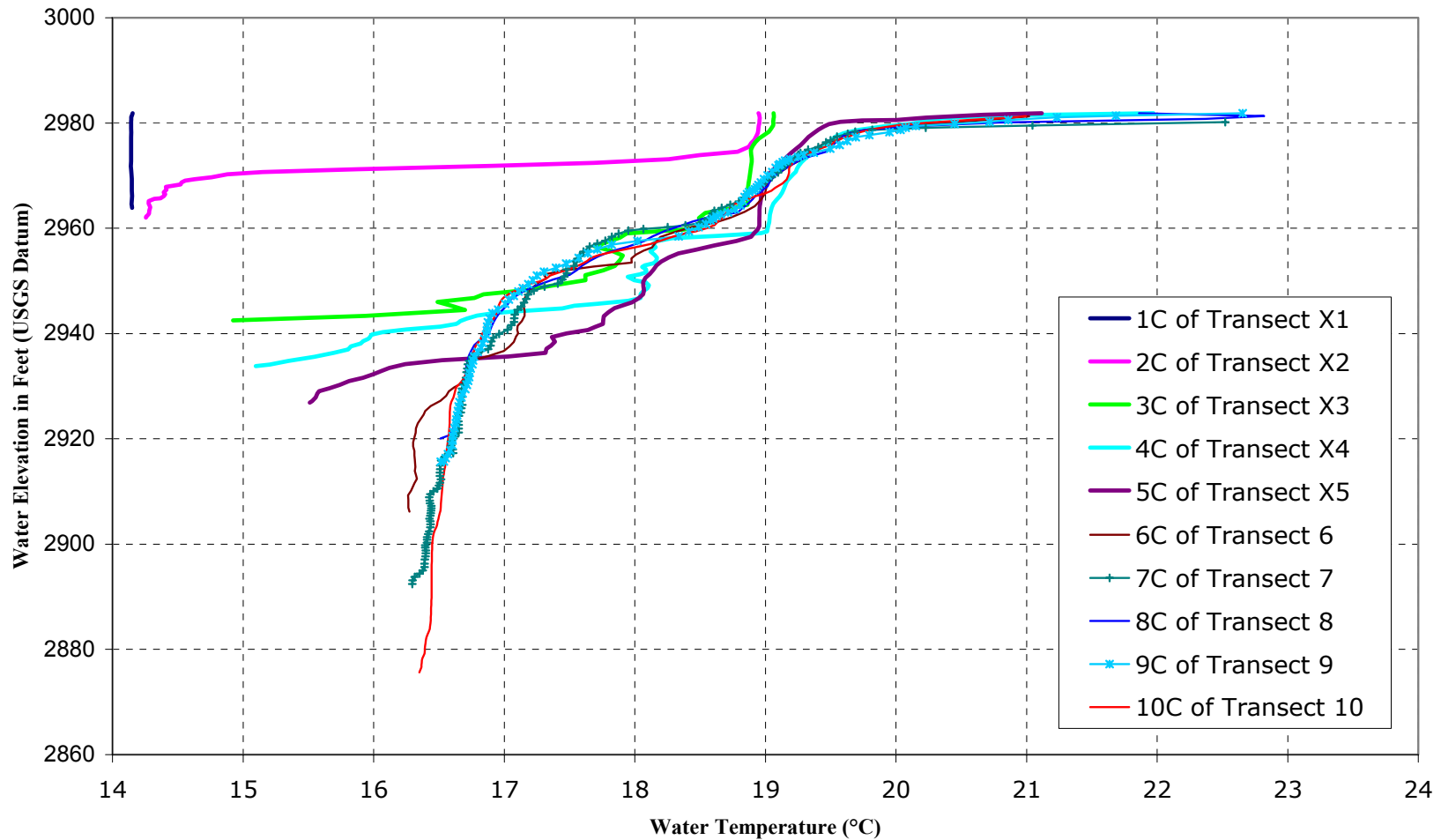


Figure 2-14 Observed Mean Daily Water Temperatures at Various Strata of Belden Reservoir near Dam (BDR2) during Summer 2006 Special Test
 (Refer to Figure 2-12 for monitoring location BDR2)

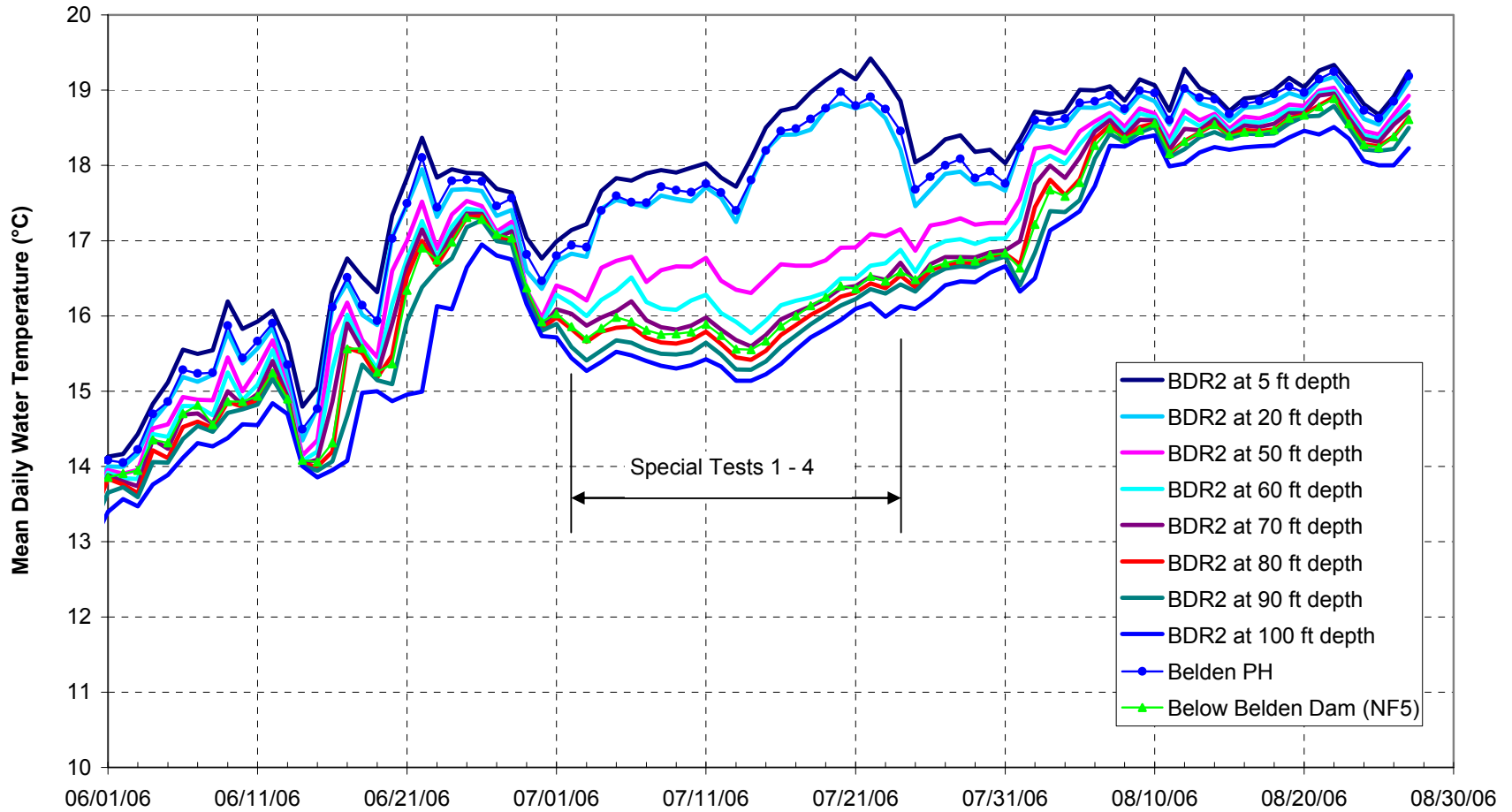


Figure 2-15 Observed Temperature Profiles of Rock Creek Reservoir near Dam during Summer 2006 Special Test

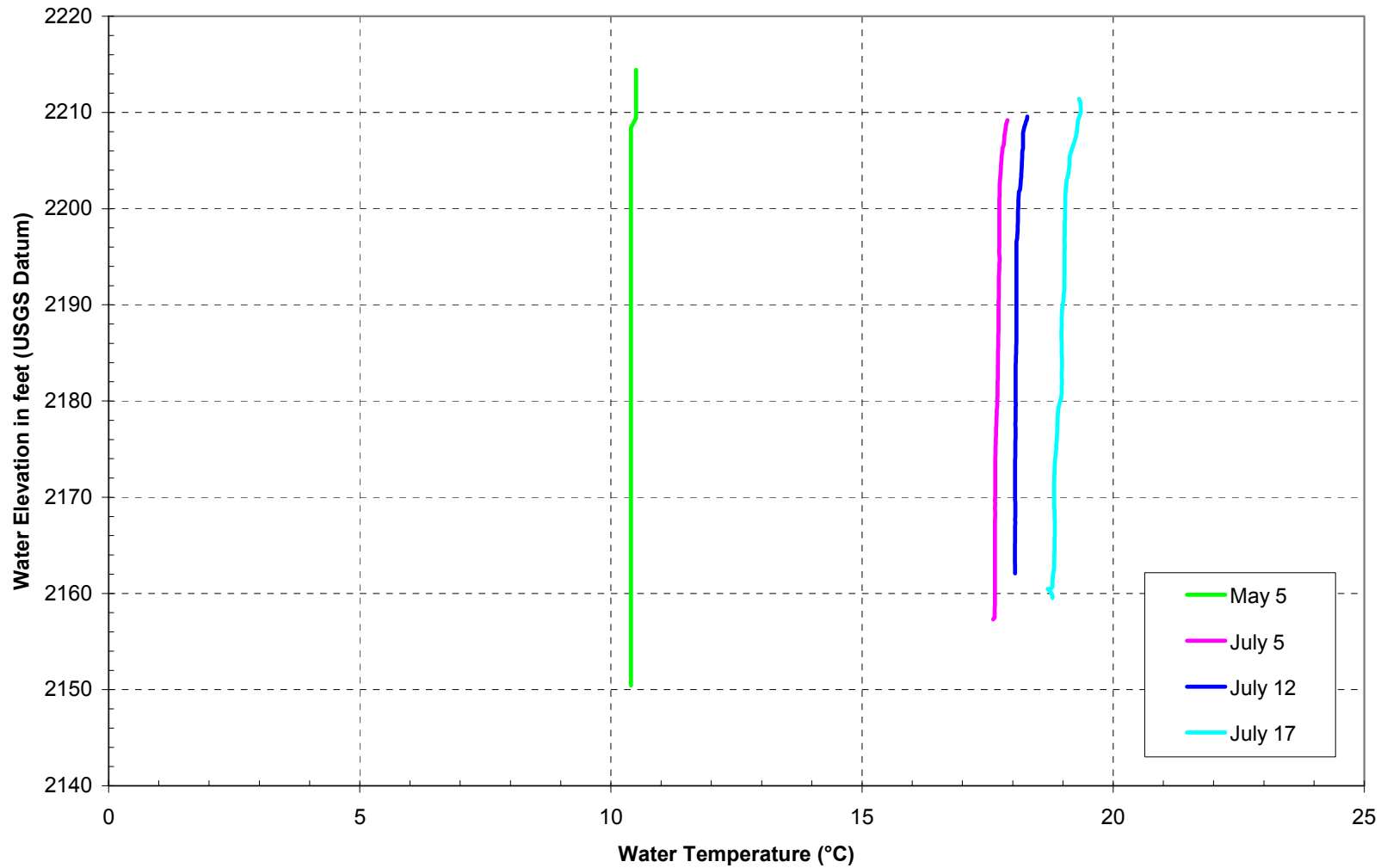


Figure 2-16 Observed Butt Valley PH Mean Daily Discharges and Discharge Water Temperatures during Summer 2006 Special Test

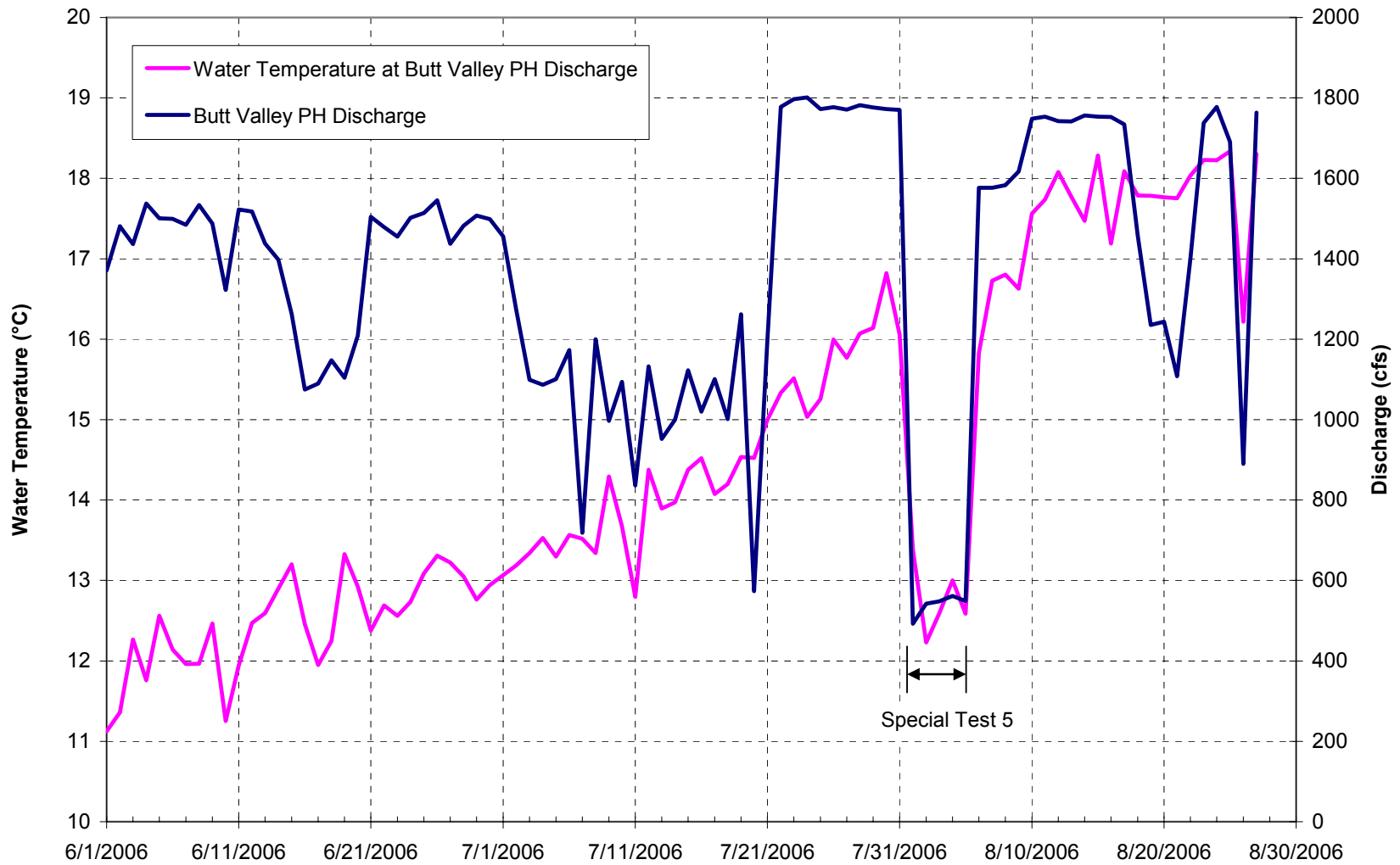


Figure 2-17 Butt Valley Reservoir Temperature Profile Monitoring Sites and Current Velocity Transects during Summer 2006 Special Test

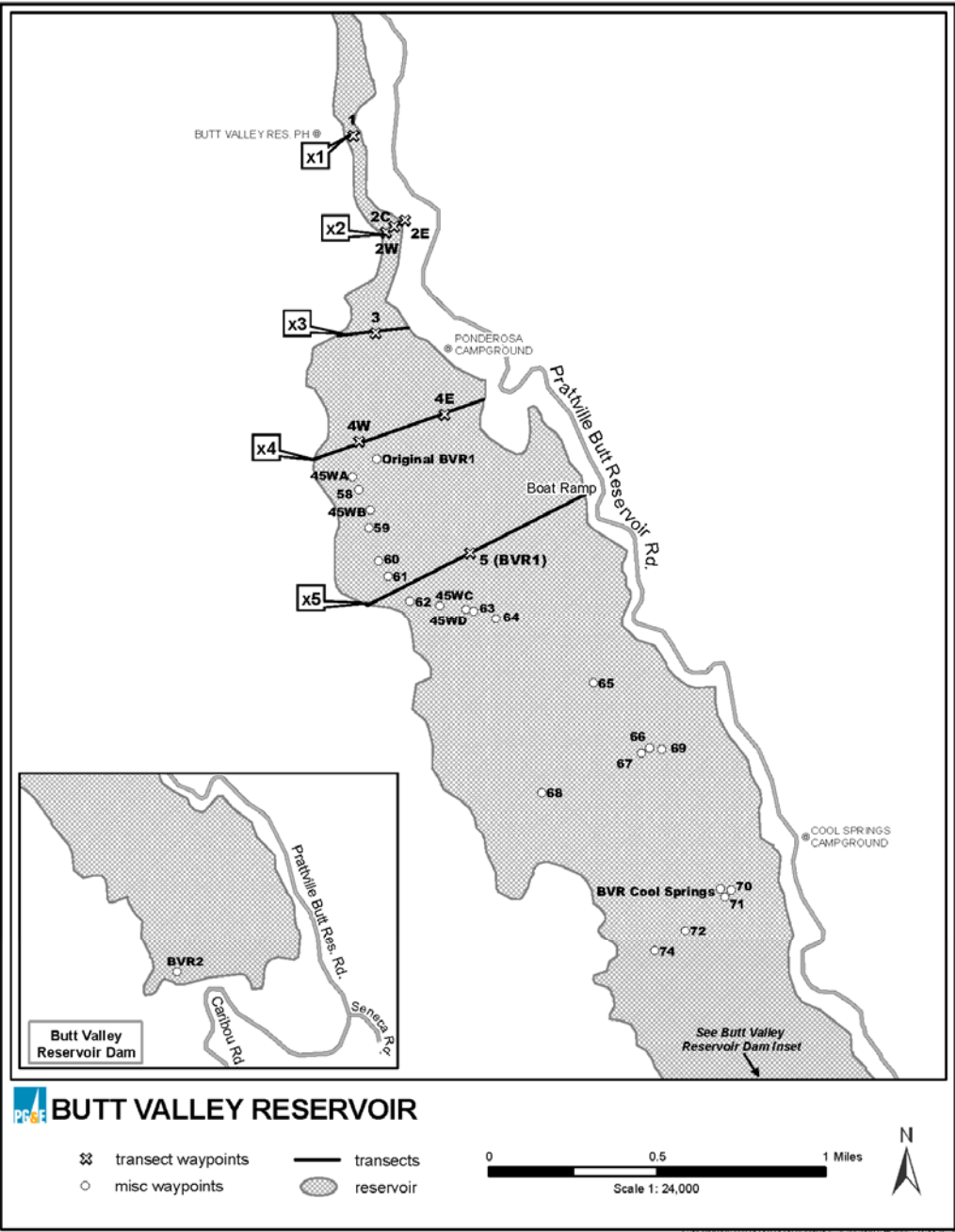
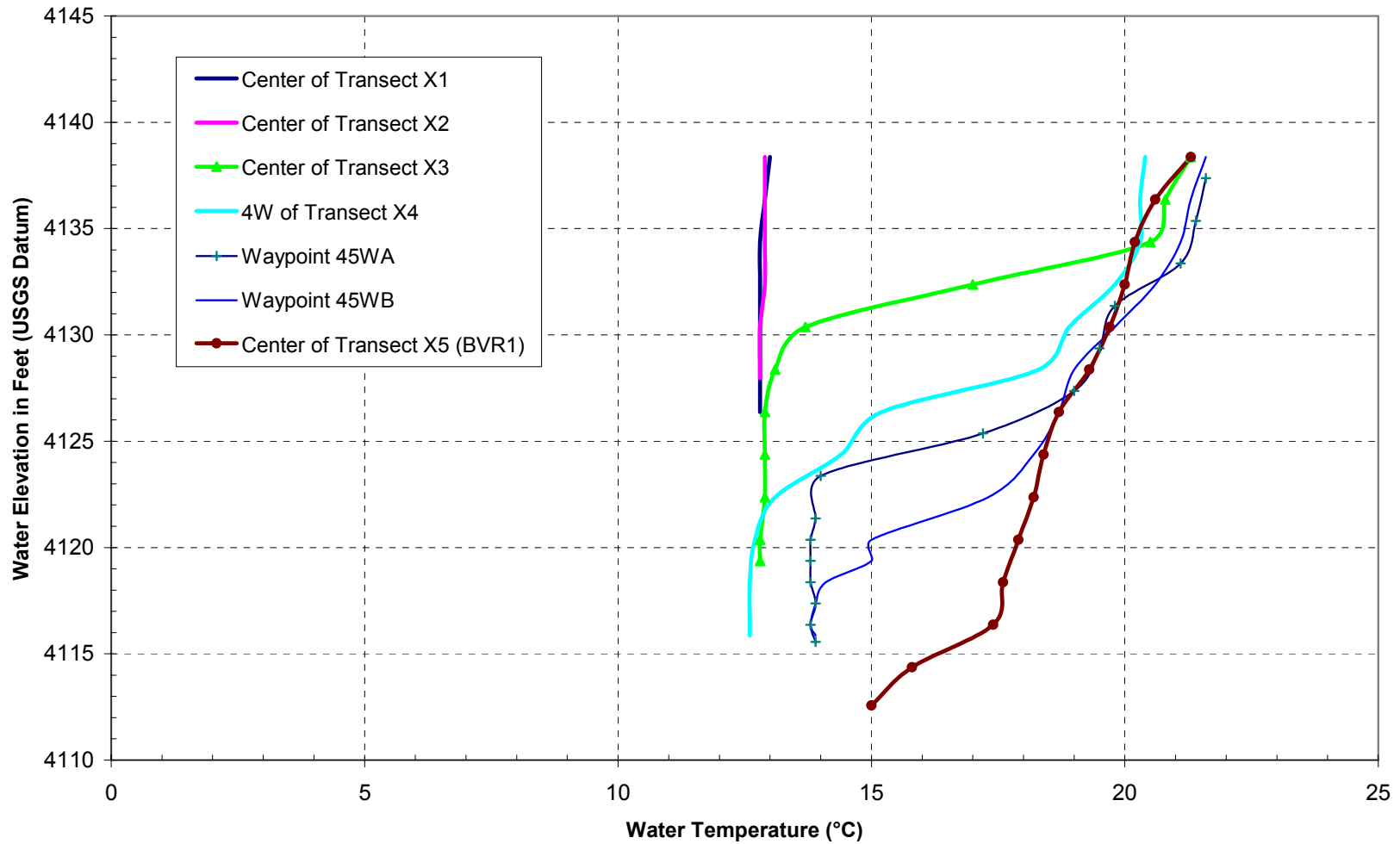


Figure 2-18 Observed Water Temperature Profiles along the Upper Portion of Butt Valley Reservoir
August 3, 2006
 (Refer to Figure 2-17 for monitoring locations)



3.0 FRAMEWORK FOR DEVELOPING AND SCREENING WATER TEMPERATURE REDUCTION ALTERNATIVES

Consistent with preparing an EIR, the CEQA alternative development process requires that alternatives evaluated in the EIR should be reasonable, feasible and implementable. The complexity of the NFFR system hydrology and thermal regime and the large number of potential water temperature reduction measures under consideration demands that a systematic approach be followed to develop and screen potential water temperature reduction alternatives (refer to Appendix C for presentation of potential water temperature reduction measures). This chapter describes the framework used for such an approach and introduces the resulting categories of potential water temperature reduction alternatives initially considered by the State Water Board in the Level 1 evaluation.

A temperature value of 20°C *maximum* mean daily²⁰ was used as the water temperature target in the framework for developing Level 1 water temperature reduction alternatives. Using this screening target assured that 20°C mean daily temperature would be accomplished on all days comprising the analysis period. Use of an *average* mean daily temperature of 20°C as the target was considered, but this would have meant that in some days 20°C mean daily temperature could be exceeded (provided that such exceedences were offset by days with mean daily temperatures less than 20°C). Using a 20°C *maximum* mean daily as the temperature target offers greater assurance that the water temperature reduction alternatives would be protective of cold freshwater habitat under all ambient conditions at specified locations within the NFFR. Further, 20°C *maximum* mean daily is consistent with the target temperature required in the Rock Creek and Cresta Reaches under the Rock Creek – Cresta Relicensing Settlement Agreement.²¹ As discussed in section 1.4, use of 20°C *maximum* mean daily as the temperature target assumes that 20°C is feasibly attainable through modifications to the UNFFR Project. This temperature target may be modified following Level 3 screening if, after advanced analysis, a different and more appropriate temperature target is identified as feasibly attainable through modification or re-operation of the UNFFR Project.

The month of July 2002 was used as the analysis period²² in the framework. Data from this month represents the most adverse conditions for achieving the temperature target, as compared to all months during PG&E's summer 2002 – 2004 monitoring period. Any water temperature reduction alternative that could achieve the target during July 2002 could likely do so during the summer months of any wet, normal, and most dry years.²³

²⁰ It is important to distinguish between two terms that are used in this report; *maximum* mean daily temperature and *average* mean daily temperature. Mean daily temperature is defined as the computed mean value for a given calendar day based on the 24 hourly temperature measurements. In a month, there are 30 or 31 mean daily temperature values. The *maximum* mean daily temperature for a month is the highest of the 30 or 31 mean daily temperature values, and the *average* mean daily temperature is the computed average of the 30 or 31 mean daily temperatures values.

²¹ The Rock Creek – Cresta Relicensing Settlement Agreement states: "In order to reasonably protect cold freshwater habitat, Licensee shall maintain mean daily water temperatures of 20 degrees Celsius or less in the Rock Creek and Cresta Reaches, to the extent that Licensee can reasonably control such temperatures".

²² The thermal regime of the NFFR during PG&E's summer 2002 – 2004 monitoring period and, in particular, during July 2002 is explained in Chapter 2.

²³ Using the long-term meteorological data synthesized by PG&E for the Prattville Intake station from 1948 to 2001 and the observed meteorological data from 2002 to 2004, it is estimated that July 2002 meteorological conditions were more heat inducing than the 5% exceedance condition.

3.1 FRAMEWORK

The “framework concept” approaches the problem of reducing water temperatures along the entire NFFR by developing solutions on a reach-by-reach scale. Solutions identified in each reach become available as interchangeable measures that can be combined as necessary, constituting a comprehensive water temperature reduction alternative for the NFFR. The framework provides alternatives that focus on reducing the temperature of water delivered to and discharged from Belden Reservoir, then builds from this point by adding measures as necessary to satisfy the temperature needs in all reaches of the NFFR. Because most of the water delivered to the downstream reaches is dispatched from Belden Reservoir, it follows that temperature reduction at Belden Reservoir is central to temperature reduction in the downstream reaches. Other factors influence downstream NFFR temperatures, including warming due to inflows from the East Branch and atmospheric effects. Nonetheless, the cooler the water available for discharge from Belden Reservoir, the less the water needs to be cooled downstream to meet the target. Conversely, the warmer the water discharged from Belden Reservoir is, the more the water needs to be cooled downstream to meet the target. The framework provides alternatives that further reduce the temperature, as needed to achieve the temperature target along each of the four downstream reaches. Use of the framework concept allows for the formulation, analysis, and evaluation of a full range of alternative ways to reduce the temperature of water in Belden Reservoir combined with additional cooling along the downstream reaches. Since water temperature reduction at Belden Reservoir is central to temperature reduction in the downstream reaches, the framework defines and differentiates alternatives primarily by the amount and method of temperature reduction achieved at Belden Reservoir.

Because the temperature of water discharged from Belden Reservoir drives the amount of cooling required in the downstream reaches, an analysis was performed to determine, over a range of starting water temperatures in Belden Reservoir, the additional cooling that would be needed to achieve the temperature target in all downstream reaches. July 2002 water temperature profiles for the NFFR were estimated for a range of starting water temperatures in Belden Reservoir. The profiles were estimated based on July 2002 meteorological conditions, observed temperature changes in the Belden and Rock Creek Reservoirs, and use of temperature modeling of the Belden, Rock Creek, Cresta, and Poe Reaches, as described below:

- a. PG&E developed SNTMP models for all the NFFR reaches (i.e., Seneca, Belden, Rock Creek, Cresta, and Poe Reaches). The SNTMP models were used to estimate the July 2002 water temperature profiles for a range of starting temperatures in Belden Reservoir.

July 2002 meteorological data collected at the Prattville Intake station were used in the SNTMP models for the Belden Reach, and data collected at the Rock Creek Dam meteorological station were used for the Rock Creek and Cresta Reaches. PG&E did not collect data at the Poe station in 2002, but did collect data in 1999, 2000, and 2003. Poe station humidity, solar radiation, and wind speed for July 2002 were estimated by averaging the data for July 1999, 2000, and 2003 – these were all normal water years. Poe station air temperature for July 2002 was estimated based on the July 2002 and 2003 air temperatures at the Rock Creek Dam station and the July 2003 air temperature at Poe station according to the following equation:

$$\text{Temperature}_{\text{Poe 2002}} = \text{Temperature}_{\text{RC 2002}} + (\text{Temperature}_{\text{Poe 2003}} - \text{Temperature}_{\text{RC 2003}})$$

Measured and calculated meteorology data used in the SNTMP models is summarized in Table 3-1.

The SNTMP models were run for one single time period, July 2002, using observed average mean daily flows and water temperatures. The results of the model runs were compared against the observed July 2002 average mean daily temperatures at stations along the NFFR (Table 3-2). The errors were in the range of -0.3°C to $+0.2^{\circ}\text{C}$. For purposes of this effort, errors in this range were considered acceptable by Stetson and the State Water Board and the SNTMP models were considered tested and verified.

- b. Using the verified SNTMP models, July 2002 average mean daily temperature profiles of the NFFR were estimated for a range of starting temperatures in Belden Reservoir. Flow and temperature inputs into the models consisted of observed July 2002 average mean daily flows and temperatures at the powerhouses and tributaries. Flow releases from dams that were input into the models were as follows:
 - i) Belden Dam releases to Belden Reach were those given in the Partial Settlement, for Dry year conditions;
 - ii) Rock Creek Dam releases to the Rock Creek Reach and Cresta Dam releases to the Cresta Reach were those given in the 2000 Relicensing Settlement Agreement for Rock Creek-Cresta, First 5-year Dry year conditions;
 - iii) Poe Dam releases to the Poe Reach were those given in the 2005 Draft 4(e) Conditions, Dry year conditions for Poe (Figure 3-1).
- c. The temperature profiles incorporate the following assumptions based on previously described observations from the July 2003 Caribou special test (Section 2.3.1):
 - i) Temperatures below Belden Dam were assumed 1.0°C lower than Belden Forebay when the forebay temperature was 19.5°C ; 0.5°C lower when the forebay temperature was 18.5°C ; and no difference when the forebay temperature was 17.5°C or lower;
 - ii) Temperatures in the lower (farther downstream) part of Rock Creek Reservoir were assumed 0.6°C warmer than the upper part when the Belden Forebay temperature was 18.5°C ; 1.0°C warmer when the forebay temperature was 17.5°C ; and no difference when the forebay temperature was 19.5°C or higher.
- d. Temperature profiles for July 2002 maximum mean daily temperature were estimated by first increasing the July 2002 average mean daily temperatures at the starting points of respective reaches by the same amounts of difference that were observed during the July 2002 monitoring. Then the profiles for the rest of the reaches were estimated using the SNTMP models. The estimated average mean daily/maximum daily temperatures for specified Belden Reservoir temperatures are shown in Figures 3-2a – 3-2g and a summary of average mean daily temperatures for the range of specified Belden Reservoir temperatures is shown in Figure 3-3).
- e. The temperature profiles show the following:

- i) When the Belden Forebay temperature is 12.5°C or lower, the target (average and maximum mean daily) is achieved along all reaches of the NFFR without the need for additional temperature reduction below Belden Reservoir (Figure 3-2g);
- ii) When the Belden Forebay temperature is 14.5°C the target (average and maximum mean daily) is achieved along all reaches of the NFFR without the need for additional temperature reduction below Belden Reservoir (Figure 3-2f), except for
 - the lower portion of the Belden Reach below East Branch where the maximum mean daily temperature may exceed the target by up to 0.6°C; and,
 - the lower portion of the Poe Reach where the maximum mean daily temperature may exceed the target by up to 0.8°C.
- iii) When the Belden Forebay temperature is 15.5°C the target (average and maximum mean daily) is achieved along all reaches of the NFFR without the need for additional temperature reduction below Belden Reservoir (Figure 3-2e), except for
 - the portion of the Belden Reach below the East Branch where the maximum mean daily temperature may exceed the target by about 1.0°C;
 - the lower portion of the Cresta Reach where the maximum mean daily temperature may exceed the target by about 0.4°C; and,
 - the lower portion of the Poe Reach where both the average mean daily and maximum mean daily temperatures may exceed the target.
- iv) When the Belden Forebay temperature is 16.5°C the target (average mean daily) is achieved along all reaches of the NFFR without the need for additional temperature reduction below Belden Reservoir (Figure 3-2d), except for
 - the portion of the Belden Reach below the East Branch where the average mean daily temperature may exceed the target slightly and the maximum mean daily temperature may exceed the target by about 1.4°C;
 - the Rock Creek Reach where the maximum mean daily temperature may exceed the target by up to 0.5°C;
 - the Cresta Reach where the maximum mean daily temperature may exceed the target by up to 0.7°C; and,
 - the Poe Reach where both the maximum mean daily and average mean daily temperatures may exceed the target throughout the reach.
- v) When the Belden Forebay temperature is either 17.5°C or 18.5°C the target (average mean daily and maximum mean daily) is generally achieved only along the upper Belden Reach above the East Branch – although a Belden Forebay temperature of 18.0°C would assure that the maximum mean daily temperature meets the target. In all reaches of the NFFR below the East Branch, the target is generally exceeded. (Figured 3-2b and 3-2c).
- vi) When the Belden Forebay temperature is 19.5°C the target temperature (average mean daily) is achieved only along the upper Belden Reach above the East Branch
 - the maximum mean daily temperature exceeds the target. Below the East Branch the target is generally exceeded. (Figure 3-2a).
- vii) Reducing the Belden Forebay temperature from 19.5°C to 17.5°C has little benefit to downstream reaches (except that this causes the upper Belden Reach to meet the maximum mean daily target; Figure 3-3) because when the Belden Forebay

temperature is reduced (1) warming in Rock Creek Reservoir occurs and (2) diminished stratification occurs in Belden Reservoir.

- viii) Reducing the Belden Forebay temperature by 1°C from a starting temperature of 17.5°C results in the following reductions in average mean daily temperatures downstream (Figure 3-3):
- Belden Reach above the East Branch, 0.8°C;
 - Rock Creek Reach above Bucks Creek/Buck PH, 0.6°C;
 - Cresta Reach above Cresta PH, 0.5°C; and,
 - Poe Reach above Poe PH, 0.4°C.
- f. The SNTMP models for July 2002 were further used to estimate the release temperatures at each dam that would be required to achieve the target (average mean daily and maximum mean daily) for the respective downstream reaches (Figure 3-4a). The average/maximum mean daily July 2002 release temperatures required to achieve the temperature target are:
- i) Belden Dam to Belden Reach, 13.0°C/14.7°C (If the lower portion of the Belden Reach is sacrificed, then the required release temperature from Belden Dam is raised by 5°C to 18.0°C/19.7 °C (Figure 3-4b).);
 - ii) Rock Creek Dam to Rock Creek Reach, 17.8°C/19.0 °C;
 - iii) Cresta Dam to Cresta Reach, 17.3°C/18.3 °C; and,
 - iv) Poe Dam to Poe Reach, 16.4°C/17.4 °C.
- g. The following uncertainties exist in the above analysis. More detailed analysis using mathematical models is needed to address these uncertainties.
- i) In the analysis, temperatures below Belden Dam were assumed 1.0°C lower than Belden Forebay when the forebay temperature was 19.5°C; 0.5°C lower when the forebay temperature was 18.5°C; and no difference when the forebay temperature was 17.5°C or lower. These assumptions were solely based on observations during the July 2003 Caribou special test. Further detailed analysis is needed since the extent of Belden Reservoir stratification would depend on peaking operations and discharge rates of the Caribou powerhouses and the rate of cool water inflow from Seneca Reach.
 - ii) In the analysis, temperatures in the lower part of Rock Creek Reservoir (near the dam) were assumed 0.6°C warmer than the upper part when the Belden Forebay temperature was 18.5°C; 1.0°C warmer when the forebay temperature was 17.5°C or lower; and no difference when the forebay temperature was 19.5°C or higher. In fact it would be expected that the warming at Rock Creek Reservoir would be more pronounced when the inflow water temperature was lower than 17.5°C.

3.2 WATER TEMPERATURE REDUCTION ALTERNATIVE CATEGORIES

Results of the above-described modeling work formed the basis for the formulation of six categories of water temperature reduction alternatives (Table 3-3). The categories are differentiated by the amount of temperature reduction at Belden Reservoir. A higher numbered

category means that more temperature reduction is required in reaches downstream. The water temperature reduction alternative categories are described below:

- a. **Water Temperature Reduction Alternative Category 1: Reduce the temperature in Belden Forebay to 12.5°C.** This category includes alternatives consisting of measures that would significantly reduce the temperatures of the source waters to the Belden Forebay without the need for additional temperature reduction below the dam. Measures in this category are included in Appendix C under the headings “Measures Above or at Lake Almanor” and “Measures At Butt Valley Reservoir”.
- b. **Water Temperature Reduction Alternative Category 2: Reduce the temperature in Belden Forebay to 14.5°C combined with additional temperature reduction along the Poe Reach.** This category includes measures that would also significantly reduce the temperatures of the source waters to the Belden Forebay (but not as much as Category 1) combined with measures that would reduce temperatures along the lower portion of the Poe Reach – no additional measures would be necessarily needed for the Belden, Rock Creek and Cresta Reaches, although measures along these reaches that would also reduce temperatures along the Poe Reach would also work. Measures in this category are included in Appendix C under the headings “Above or at Lake Almanor” and “At Butt Valley” combined with other headings, particularly “Measures Along Poe Reach”.
- c. **Water Temperature Reduction Alternative Category 3: Reduce the temperature in Belden Forebay to 16.0°C combined with additional temperature reduction along the lower Belden, Cresta, and Poe Reaches.** This category includes measures that would also significantly reduce the temperatures of the source waters to the Belden Forebay (but not as much as Category 2) combined with measures that would reduce temperatures along the lower Belden Reach and the lower portions of the Cresta and Poe Reaches – no additional measures would be necessarily needed for the upper Belden and Rock Creek Reaches. Measures in this category are included in Appendix C under the headings “Above or at Lake Almanor” and “At Butt Valley” combined with other headings, particularly “Along Poe Reach” and “Along Cresta Reach”.
- d. **Water Temperature Reduction Alternative Category 4: Reduce the temperature in Belden Forebay to 18.0°C combined with additional temperature reduction along the lower Belden, Rock Creek, Cresta, and Poe Reaches.** This category includes measures that would moderately reduce the temperatures of the source waters to the Belden Forebay combined with measures that would reduce temperatures along the lower Belden, Rock Creek, Cresta, and Poe Reaches. No additional measures would necessarily be needed for the upper Belden Reach. Measures in this category are included in Appendix C under the headings “Above or at Lake Almanor” and “At Butt Valley” combined with other headings for downstream reaches.
- e. **Water Temperature Reduction Alternative Category 5: Reduce the temperature in Belden Forebay to 19.5°C combined with additional temperature reduction along all downstream reaches.** This category includes measures that would slightly reduce the temperatures of the source waters to the Belden Forebay combined with measures that would reduce temperatures along all downstream reaches. Measures in this category are included in Appendix C under the headings “Above or at Lake Almanor” and “At Butt Valley” combined with other headings for all downstream reaches.

- f. **Water Temperature Reduction Alternative Category 6:** Reduce temperatures in all downstream reaches. This category includes measures that would focus on temperature reduction in the downstream reaches, and does not necessarily require measures at Lake Almanor and Butt Valley Reservoir. However, absent measures at Lake Almanor and Butt Valley, temperature reduction in the downstream reaches would be very difficult and costly. Measures in this category are included in Appendix C under the headings “Along Belden Reach”, “Along Rock Creek Reach”, “Along Cresta Reach”, and “Along Poe Reach.”

Table 3-1 Meteorology Data in July 2002

	Prattville Intake Station	Rock Creek Dam Station	Poe Station
Mean Air Temperature (°C)	20.6	26.0	25.8
Mean Relative Humidity (%)	45	34	52
Mean Solar Radiation (watts/s)	286	279	278
Mean Wind Speed (mph)	1.10	3.01	1.61

Note: Meteorology data for the Prattville Intake and Rock Creek Dam stations were observed; meteorology data for the Poe station were estimated.

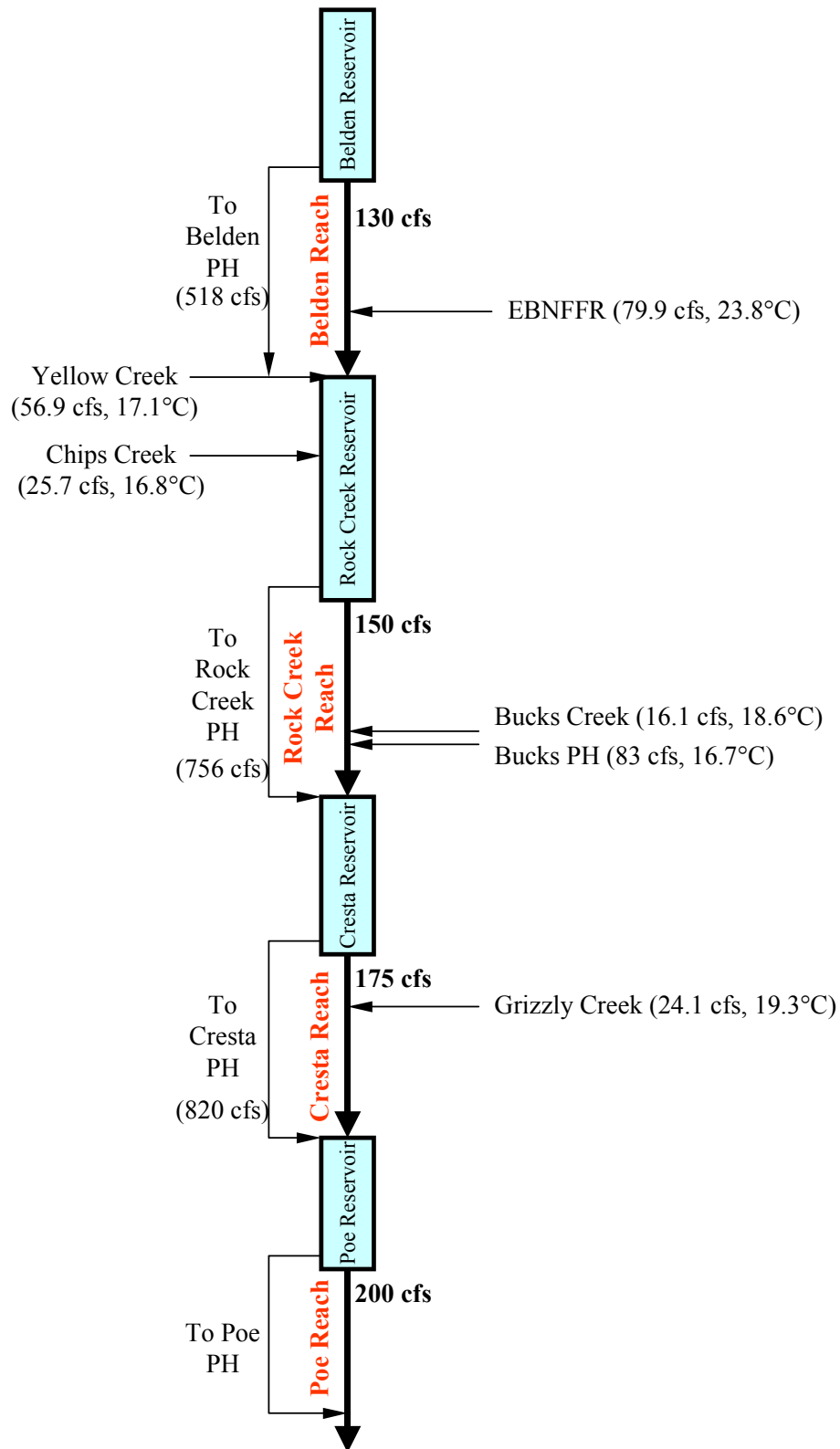
Table 3-2 SNTMP Model Verification Results Using July 2002 Data

River Reach	Calibration Station	Observed Mean Temperature (°C)	Simulated Mean Temperature (°C)	Difference (°C)
Seneca Reach	Seneca Bridge (NF3)	15.0	14.8	-0.2
	Above Caribou PH (NF4)	15.9	15.7	-0.2
Belden Reach	Above Queen Lily (NF6)	19.5	19.5	0.0
	Gansner Bar (NF7)	19.7	19.6	-0.1
	Above Belden PH (NF8)	21.4	21.4	0.0
Rock Creek Reach	Above Granite Creek (NF11)	21.5	21.6	0.1
	Above Bucks Creek (NF12)	21.6	21.8	0.2
	Above Rock Ck PH (NF13)	20.7	20.5	-0.2
Cresta Reach	Below Grizzly Ck. (NF15)	21.3	21.0	-0.3
	Above Cresta PH (NF16)	21.7	21.6	-0.1
Poe Reach	Above Poe PH	23.7	23.5	-0.2

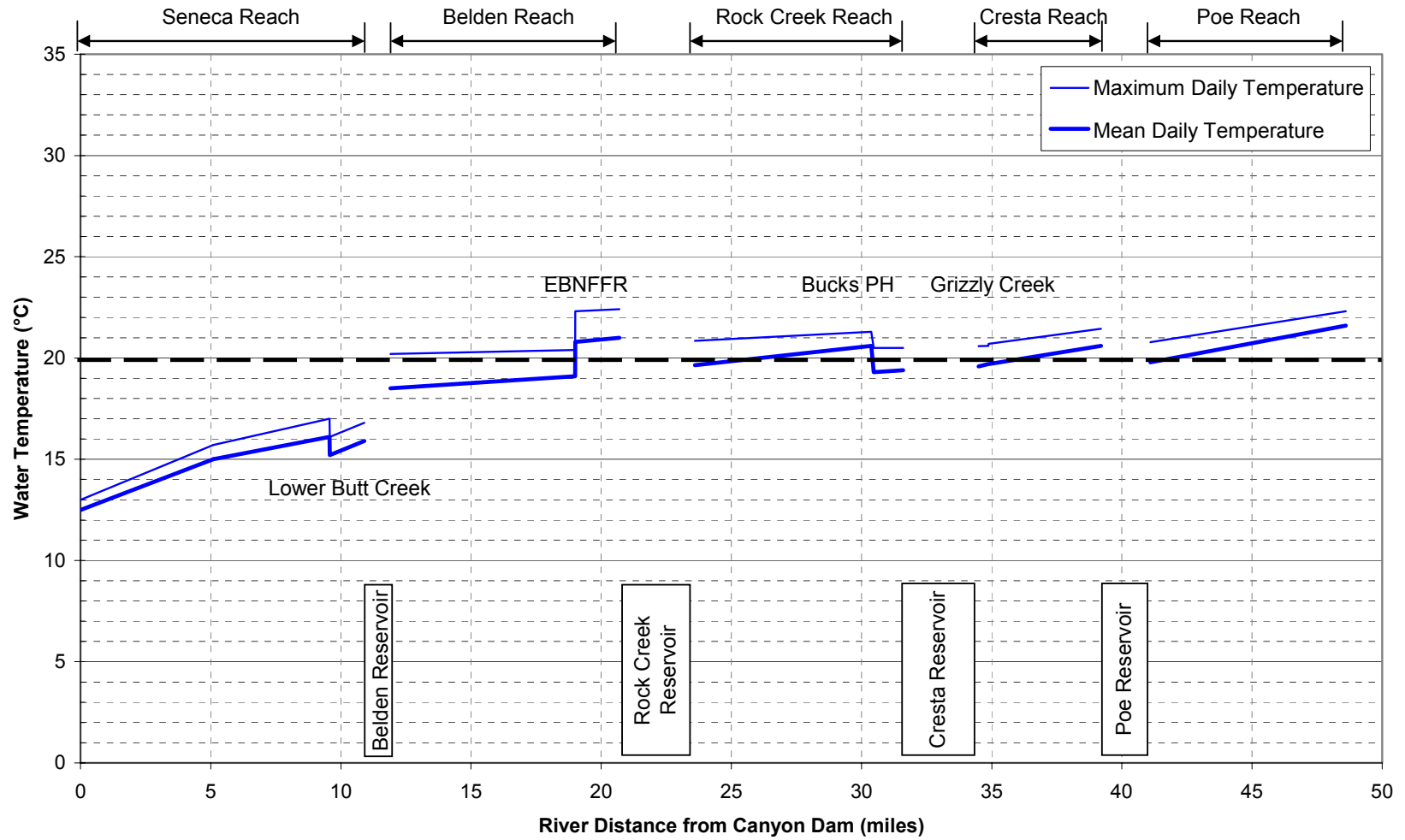
Table 3-3 Summary of Alternative Categories and Requirements

Alternative Category		Belden Reach	Rock Creek Reach	Cresta Reach	Poe Reach
1	Cold Water from Lake Almanor/Butt Valley Reservoir	Reduce inflow temperature at Belden Forebay to 12.5°C			
	Additional Cold Water Needed?	No	No	No	No
2	Cold Water from Lake Almanor/Butt Valley Reservoir	Reduce inflow temperature at Belden Forebay to 14.5°C			
	Additional Cold Water Needed?	No	No	No	Yes
3	Cold Water from Lake Almanor/Butt Valley Reservoir	Reduce inflow temperature at Belden Forebay to 16.0°C			
	Additional Cold Water Needed?	No (except for lower Belden reach)	No	Yes	Yes
4	Cold Water from Lake Almanor/Butt Valley Reservoir	Reduce inflow temperature at Belden Forebay to 18.0°C			
	Additional Cold Water Needed?	No (except for lower Belden reach)	Yes	Yes	Yes
5	Cold Water from Lake Almanor/Butt Valley Reservoir	Reduce inflow temperature at Belden Forebay to 19.5°C			
	Additional Cold Water Needed?	Yes	Yes	Yes	Yes
6	Cold Water from Lake Almanor/Butt Valley Reservoir	No			
	Additional Cold Water Needed?	Yes	Yes	Yes	Yes

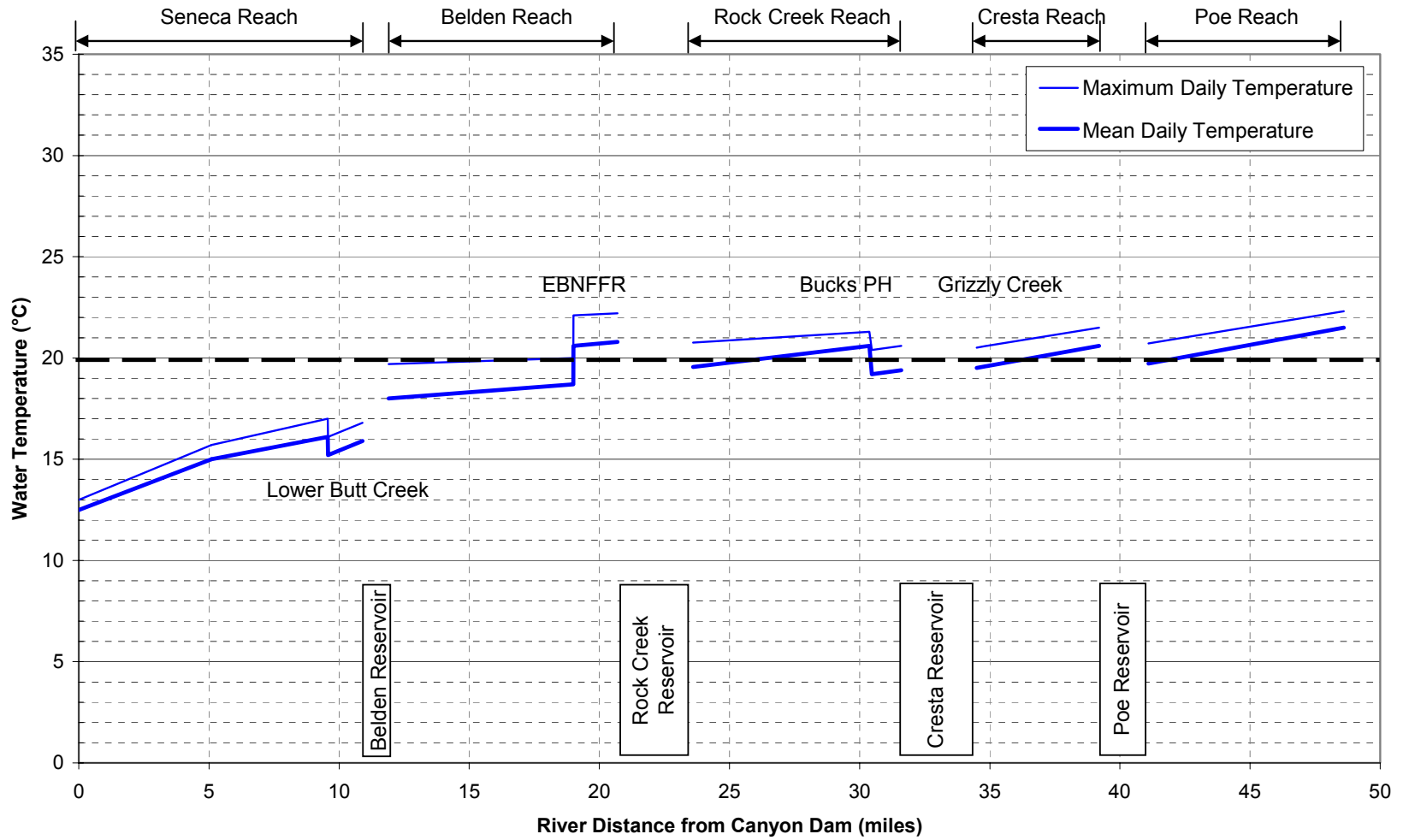
Figure 3-1 Hydrology and Temperature Data Used as Inputs in the SNTMP Modeling Analysis



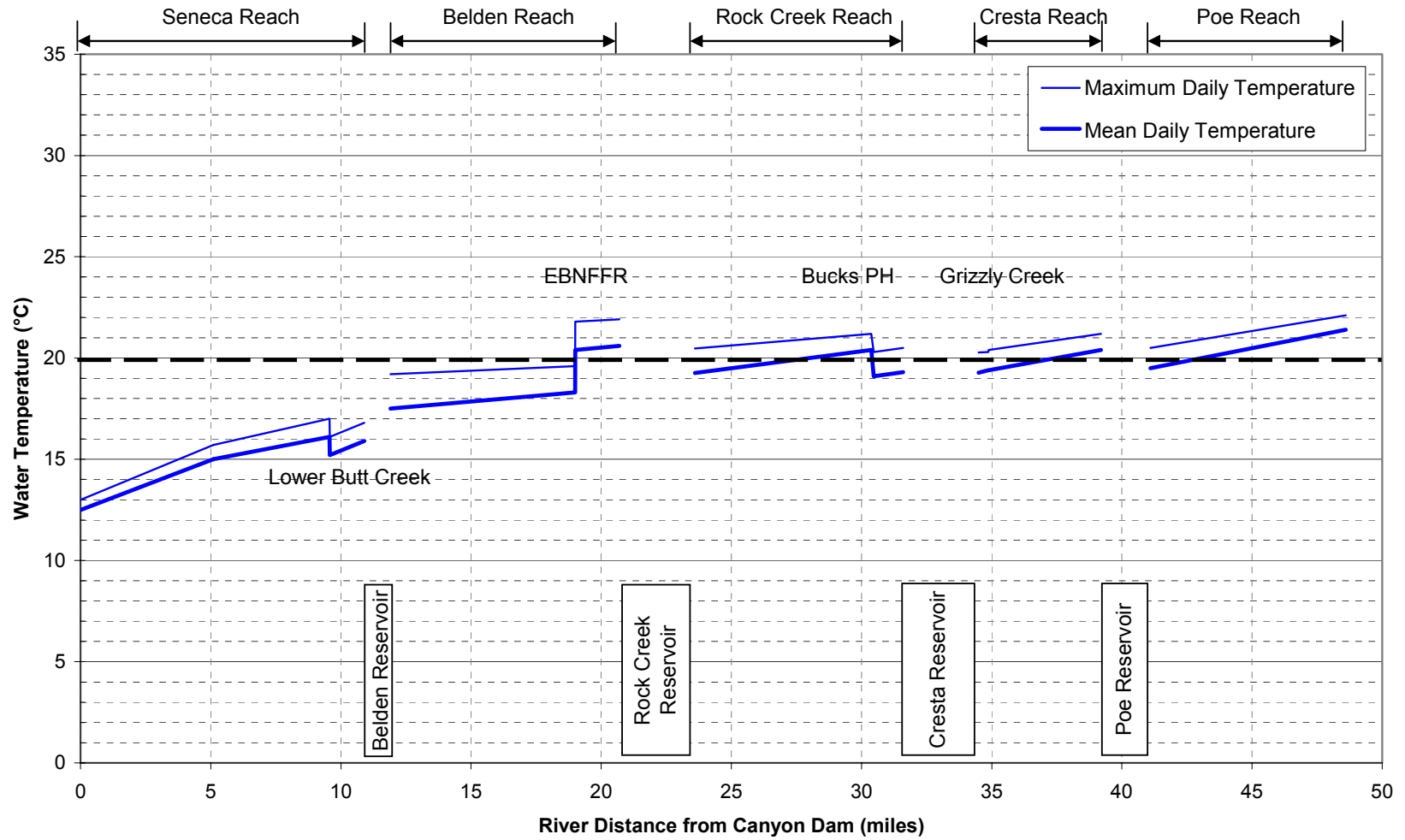
**Figure 3-2a Estimated July 2002 (Dry Year) Water Temperature Profile along NFFR
(Assuming Average Mean Daily Temperature at Belden Forebay = 19.5°C)**



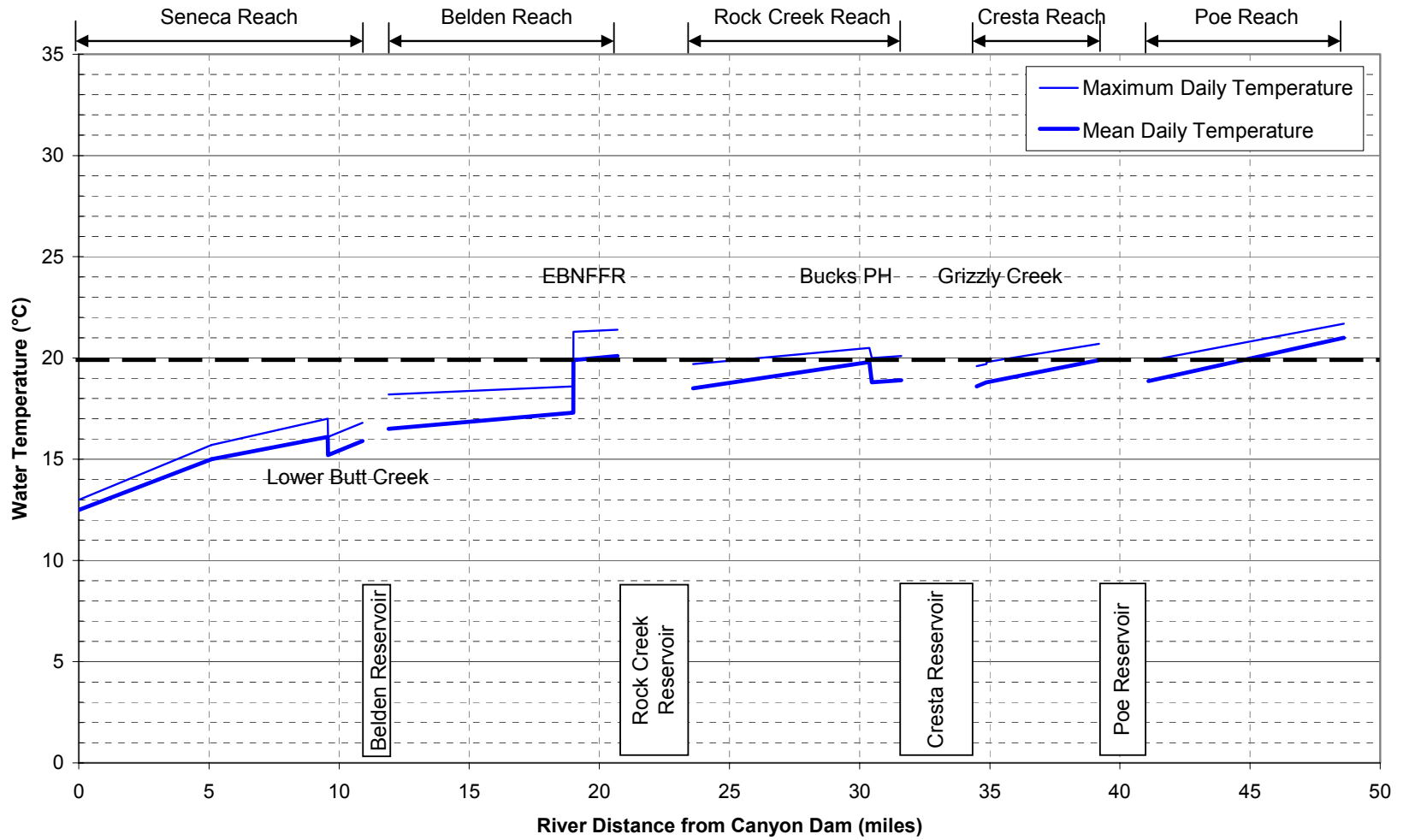
**Figure 3-2b Estimated July 2002 (Dry Year) Water Temperature Profile along NFFR
(Assuming Average Mean Daily Temperature at Belden Forebay = 18.5°C)**



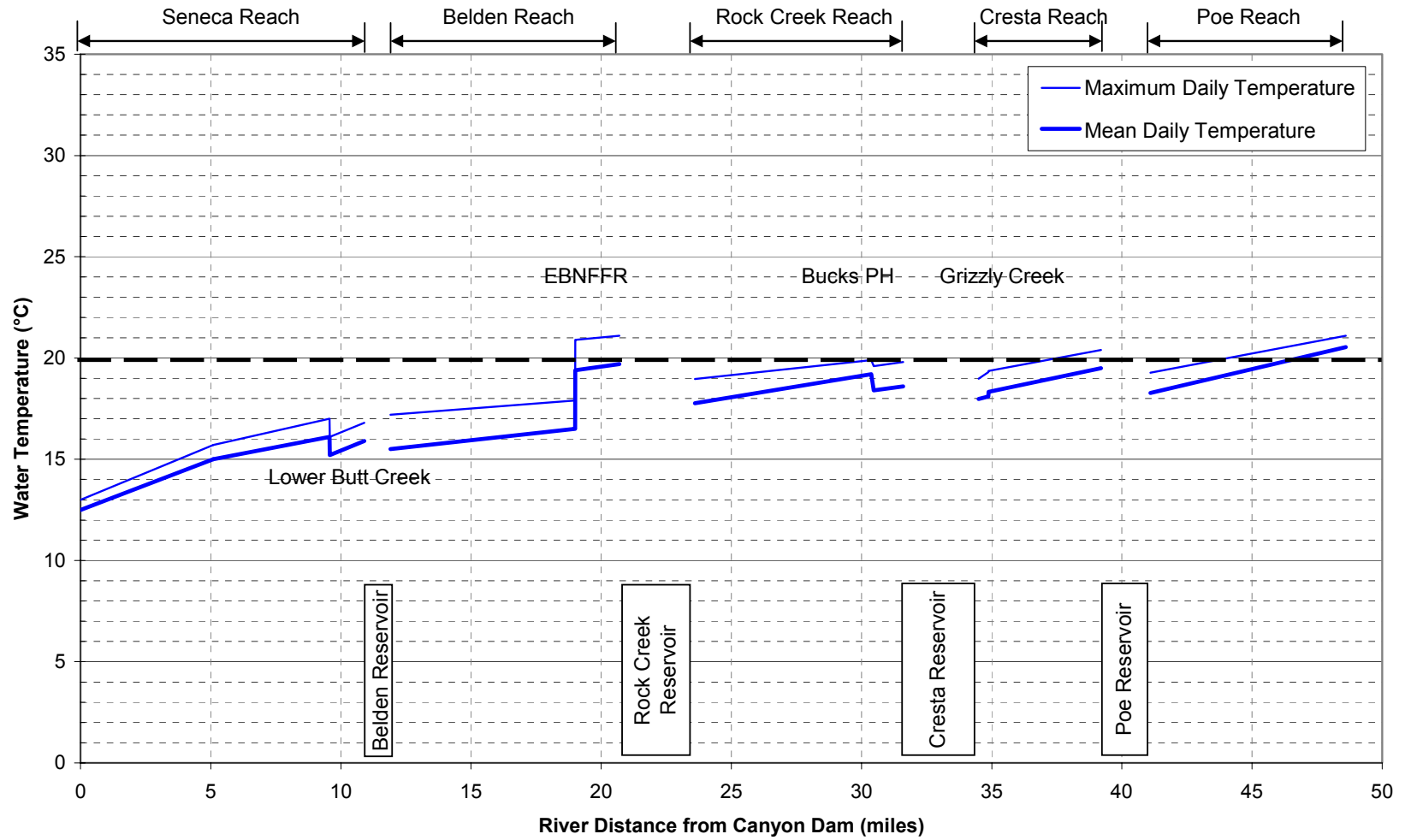
**Figure 3-2c Estimated July 2002 (Dry Year) Water Temperature Profile along NFFR
(Assuming Average Mean Daily Temperature at Belden Forebay = 17.5°C)**



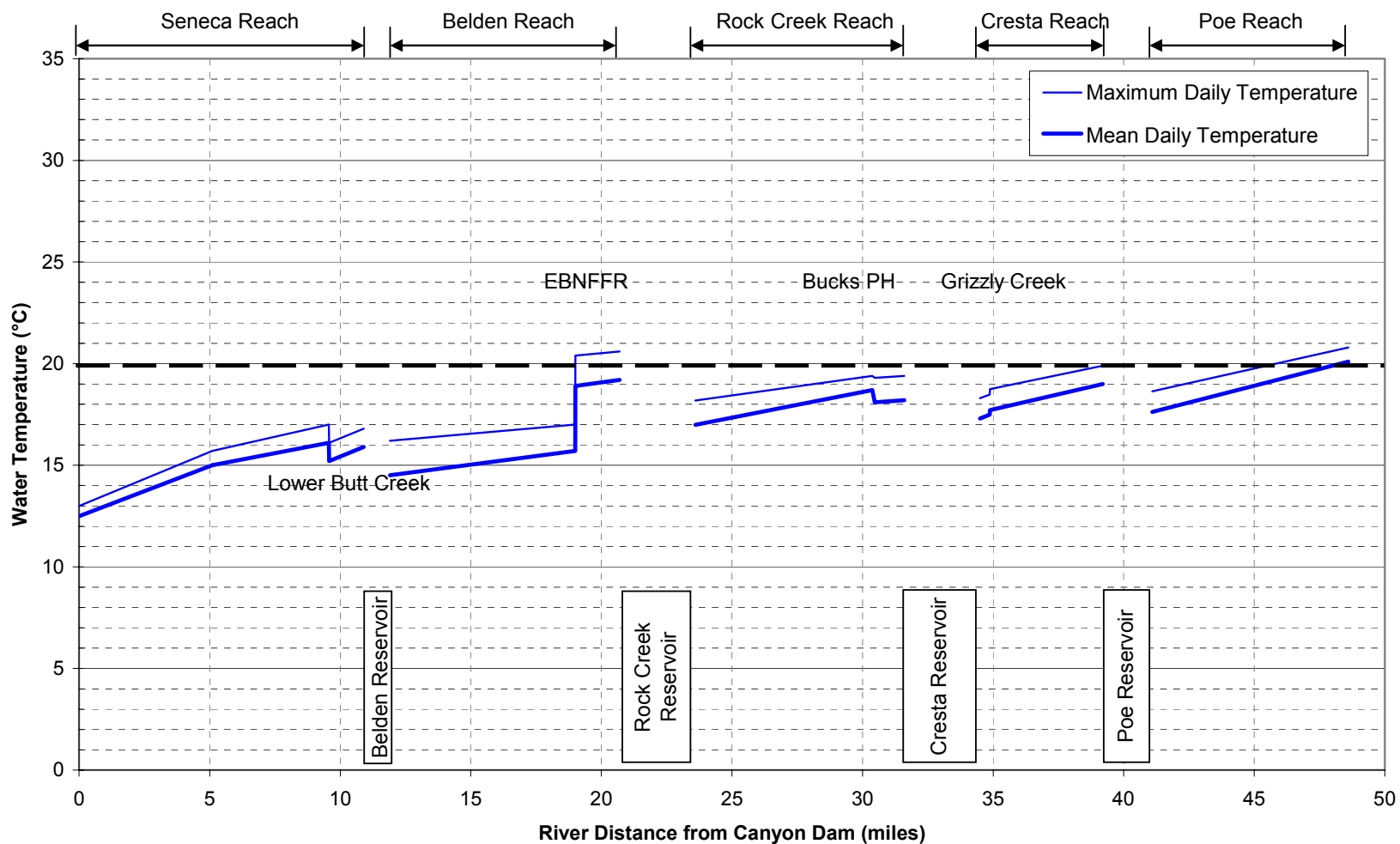
**Figure 3-2d Estimated July 2002 (Dry Year) Water Temperature Profile along NFFR
(Assuming Average Mean Daily Temperature at Belden Forebay = 16.5°C)**



**Figure 3-2e Estimated July 2002 (Dry Year) Water Temperature Profile along NFFR
(Assuming Average Mean Daily Temperature at Belden Forebay = 15.5°C)**



**Figure 3-2f Estimated July 2002 (Dry Year) Water Temperature Profile along NFFR
(Assuming Average Mean Daily Temperature at Belden Forebay = 14.5°C)**



**Figure 3-2g Estimated July 2002 (Dry Year) Water Temperature Profile along NFFR
(Assuming Average Mean Daily Temperature at Belden Forebay = 12.5°C)**

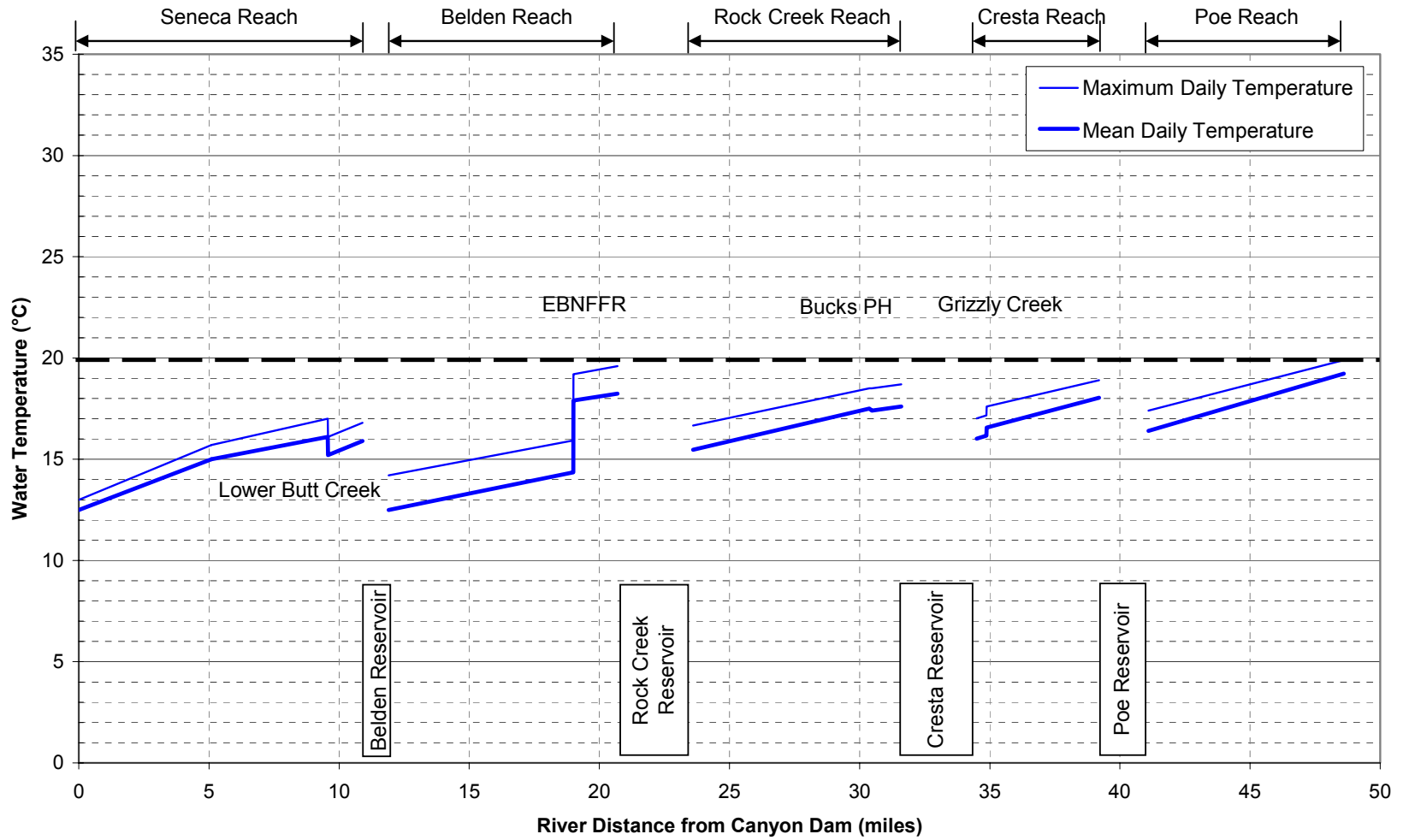


Figure 3-3 Estimated July 2002 (Dry Year) Water Temperature Profiles along NFFR for a Range of Inflow Temperatures at Belden Forebay

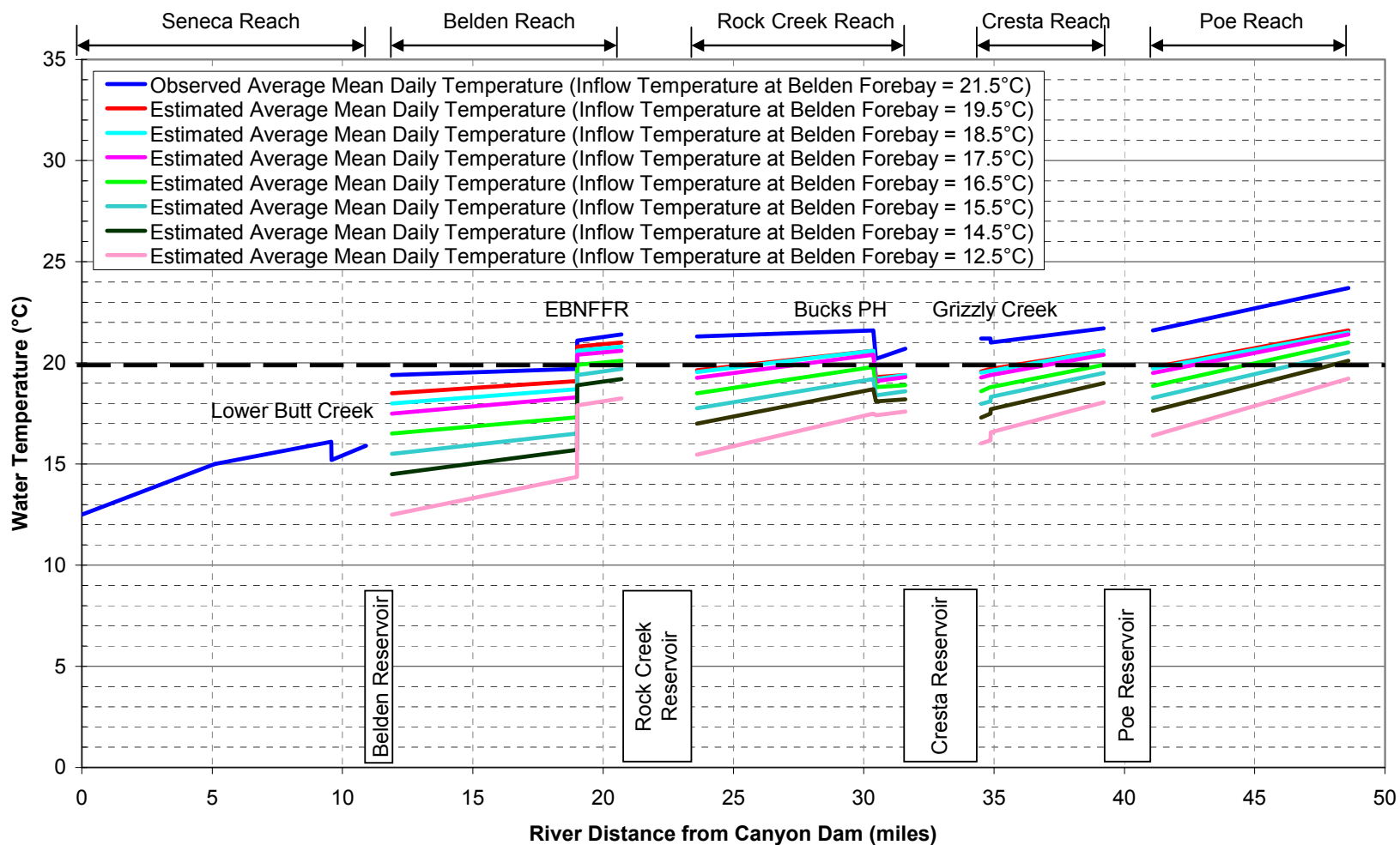


Figure 3-4a July 2002 (Dry Year) Water Temperature Profile along NFFR Required to Achieve Target

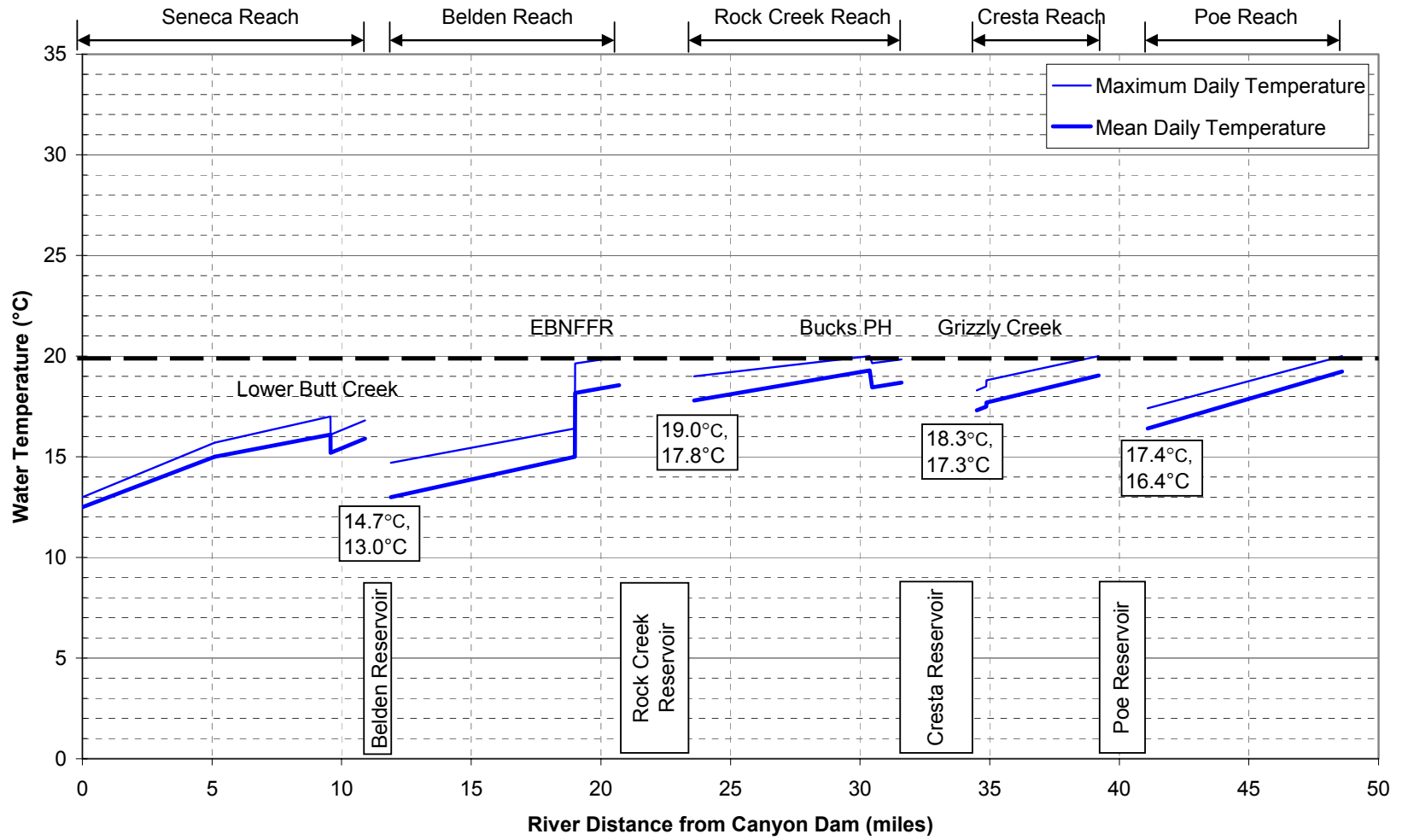
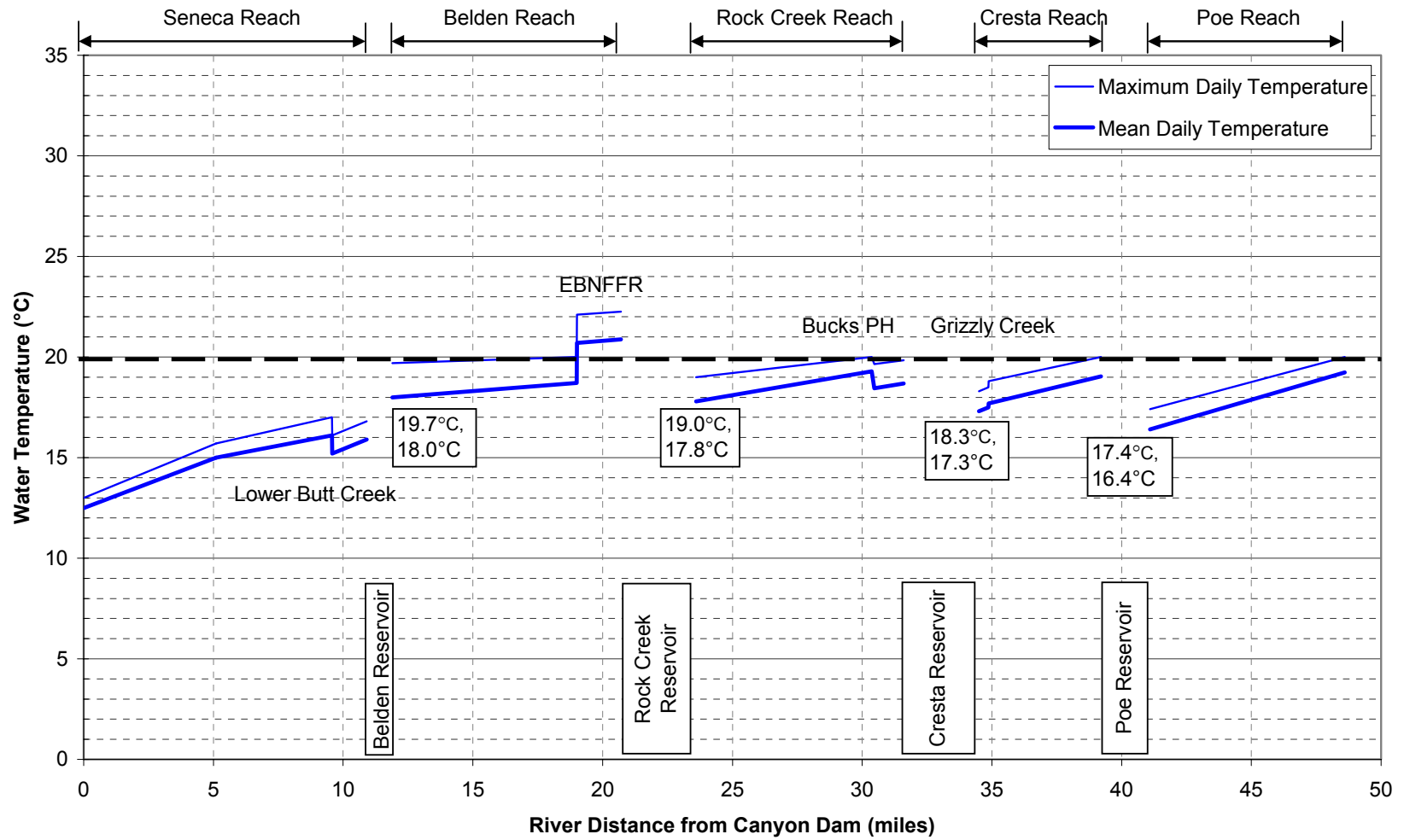


Figure 3-4b July 2002 (Dry Year) Water Temperature Profile along NFFR Required to Achieve Target with Sacrifice of Lower Belden Reach below East Branch NFFR Confluence



4.0 LEVEL 1 WATER TEMPERATURE REDUCTION ALTERNATIVES FORMULATION AND SCREENING

This chapter describes the formulation and screening of Level 1 water temperature reduction alternatives. These alternatives represent a reasonable range of *potentially effective and feasible* alternatives to achieving the temperature target. The framework described in Chapter 3 was followed in formulating the alternatives. The water temperature reduction alternatives consist of temperature reduction measures selected and assembled from those 41 measures passing the preliminary evaluation in Appendix C: Potential Effective and Feasible Measures for Reducing Temperature along the North Fork Feather River. Not all of the 41 measures passing the preliminary evaluation were selected for inclusion in the alternatives. Certain measures were excluded²⁴ because there were other, equally or more effective measures available that were clearly superior.

The effectiveness of each alternative in reducing temperatures and achieving the 20°C maximum mean daily temperature target on the NFFR was analyzed using the information and tools summarized below:

- PG&E's *Temperature Modeling Results for 33-years of the Hydrologic Record* (Bechtel Corporation and Thomas R. Payne and Associates 2006);
- PG&E's *Physical-prototype Hydraulic Modeling Results for the Prattville Intake Thermal Curtain* (IIHR 2004);
- PG&E's *2002-2004 Temperature Monitoring Data Reports* (PG&E 2003; PG&E 2004; PG&E 2005a);
- PG&E's *2006 NFFR Special Testing Data Report* (Stetson and PG&E 2007);
- Stream water temperature modeling analysis (refer to Chapter 3); and
- Water temperature mixing analysis.

4.1 FORMULATION OF INITIAL LEVEL 1 WATER TEMPERATURE REDUCTION ALTERNATIVES

Initial Level 1 water temperature reduction alternatives were formulated by category in accordance with the framework described in Chapter 3. The alternative categories are differentiated by the amount of temperature reduction at Belden Reservoir. Within a particular category, alternatives are differentiated by the method of temperature reduction at Belden Reservoir. An alternative may have multiple variations with respect to the selection of measure(s) for temperature reduction in downstream reaches. The initial Level 1 water temperature reduction alternatives are described below (summarized in Table 4-1):

²⁴ Measures from Appendix C that passed the preliminary evaluation but were excluded from the Level 1 alternatives include measures 4e, 7, 12, 13 and 15.

4.1.1 Water Temperature Reduction Alternative Category 1: Reduce the temperature in Belden Forebay to 12.5°C

This category includes a combination of measures that would significantly reduce the temperatures of the source waters to the Belden Forebay without the need for additional temperature reduction below the forebay. There is only one alternative in this category.

Alternative 1: Reduce the temperature in Belden Forebay to 12.5°C by installing a thermal curtain at Prattville Intake, pumping collected spring flows to the Intake, and conveying Butt Valley PH discharges by pipeline to Butt Valley Reservoir near Caribou PH Intake. This alternative includes the following measures:

- Install a thermal curtain at the Prattville Intake with the submerged levee removed by dredging.
- Construct an expansive, high-capacity wellfield that would pump directly from the basalt aquifer discharging to Big Springs/northeastern Lake Almanor. The pumped cold water is conveyed by pipeline laid along the lakebed and connected for direct discharge into the Prattville Intake.
- Construct about five miles of pipeline laid along the bed of Butt Valley Reservoir for conveying Butt Valley PH discharges to Butt Valley Reservoir near Caribou Intake.

Remarks:

- An estimated 215 cfs of pumped groundwater (8°C) is needed under the normal operating discharge of 1,600 cfs at Butt Valley PH. There would be no power generation loss at this operating level.
- Little information is available on the hydrogeology and development potential of the basalt aquifer at Lake Almanor. Extensive field investigation would be required to evaluate the feasibility of this alternative.

4.1.2 Water Temperature Reduction Alternative Category 2: Reduce the temperature in Belden Forebay to 14.5°C combined with additional temperature reduction along the Poe Reach

This category includes a combination of measures that would significantly reduce the temperatures of the source waters to the Belden Forebay (but not as much as Category 1) combined with measures that would reduce temperatures along the lower portion of the Poe Reach – no additional measures would be necessary for the Belden, Rock Creek and Cresta Reaches. This category has three alternatives.

Alternative 2a: Reduce the temperature in Belden Forebay to 14.5°C by installing a thermal curtain at Prattville Intake and conveying Butt Valley PH discharges by pipeline to Butt Valley Reservoir near Caribou PH Intake, with one additional temperature reduction measure for the Poe Reach. This alternative includes the following measures:

- Install a thermal curtain at the Prattville Intake with the submerged levee removed by dredging.
- Construct about five miles of pipeline laid along the bed of Butt Valley Reservoir for conveying Butt Valley PH discharges to Butt Valley Reservoir near Caribou Intake.
- Increase shading along the Poe Reach from the existing 22% level to the 50% level through planting of vegetation; or, alternatively, increase Poe Dam releases, or release cool water to the lower Poe Reach from the Poe Adit.

Remarks:

- There would be no power generation loss under this alternative if the Poe Reach temperature reduction measure is increased shading. There would be power generation loss if the Poe Reach temperature reduction measure is increased Poe Dam releases or cooler water release from the Poe Adit.

Alternative 2b: Reduce the temperature in Belden Forebay to 14.5°C by installing a thermal curtain at Prattville Intake and a thermal curtain near Caribou PH Intake in Butt Valley Reservoir and pumping collected spring flows to the Prattville Intake, with one additional temperature reduction measure for the Poe Reach. This alternative includes the following measures:

- Install a thermal curtain at the Prattville Intake with the submerged levee removed by dredging.
- Install a thermal curtain near the Caribou PH Intakes in Butt Valley Reservoir.
- Construct an expansive, high-capacity wellfield that would pump directly from the basalt aquifer discharging to Big Springs/northeastern Lake Almanor. The pumped cold water is conveyed by pipeline laid along the lakebed and connected for direct discharge into the Prattville Intake.
- Increase shading along the Poe Reach from the existing 22% level to the 50% level through planting of vegetation; or, alternatively, increase Poe Dam releases, or release cool water to the lower Poe Reach from the Poe Adit.

Remarks:

- Assuming the warming in Butt Valley Reservoir is 2°C, an estimated 215 cfs of pumped groundwater (8°C) is needed under the normal operating discharge of 1,600 cfs at Butt Valley PH.
- There would be no power generation loss under this alternative if the Poe Reach temperature reduction measure is increased shading. There would be power generation loss if the Poe Reach temperature reduction measure is increased Poe Dam releases or cooler water release from the Poe Adit.

- Little information is available on the hydrogeology and development potential of the basalt aquifer at Lake Almanor. Extensive field investigation would be required to evaluate the feasibility of this alternative.

Alternative 2c: Reduce the temperature in Belden Forebay to 14.5°C by significantly decreasing release of water from Lake Almanor to Butt Valley Reservoir through reduced withdrawal from the Prattville Intake and increased release from Canyon Dam, with one additional temperature reduction measure for the Poe Reach. This alternative includes the following measures:

- Decrease release from the Prattville Intake significantly to cause selective cold water withdrawal.
- Dredge and extend the existing deep channel along the bottom of Butt Valley Reservoir to the Caribou No. 1 Intake.
- Use Caribou PH No.1 exclusively with reduced release to cause selective cold water withdrawal.
- Increase Canyon Dam release to 600 cfs from the low level outlet.
- Increase shading along the Poe Reach from the existing 22% level to the 50% level through planting of vegetation; or, alternatively, increase Poe Dam releases, or release cool water to the lower Poe Reach from the Poe Adit.

Remarks:

- There would be significant power generation loss under this alternative due to reduced withdrawal from the Prattville Intake and increased release from Canyon Dam. This could be partially off-set by discharging Canyon Dam releases through a new hydropower plant constructed at the dam.
- Reducing the withdrawal from the Prattville Intake would result in higher Lake Almanor water levels than those that occurred historically during the summer. Higher releases than occurred historically during the fall may be required to meet obligations for water delivery downstream.

4.1.3 Water Temperature Reduction Alternative Category 3: Reduce the temperature in Belden Forebay to 16.0°C combined with additional temperature reduction measures along the lower Belden, Cresta, and Poe Reaches.

This category includes a combination of measures that would significantly reduce the temperatures of the source waters to the Belden Forebay (but not as much as Category 2) combined with measures that would reduce temperatures along the lower Belden Reach and the lower portions of the Cresta and Poe Reaches – no additional measures would be necessary for the upper Belden and Rock Creek Reaches. There is one alternative under this category.

Alternative 3: Reduce the temperature in Belden Forebay to 16.0°C by installing a thermal curtain at Prattville Intake and a thermal curtain at Butt Valley Reservoir near Caribou PH

Intake and increasing Canyon Dam release as needed, with additional temperature reduction measures for the lower Belden, Cresta and Poe Reaches. This alternative includes the following measures:

- Install a thermal curtain at the Prattville Intake with the submerged levee removed by dredging.
- Install a thermal curtain near Caribou PH Intake in Butt Valley Reservoir.
- Increase Canyon Dam low-level outlet release as needed and reduce withdrawal through the Prattville Intake commensurately.
- Convey warm water discharges from the East Branch directly into upper Rock Creek Reservoir.
- Increase Cresta Dam releases or, alternatively, increase release of cold water to the Cresta Reach from Grizzly Forebay/Grizzly Creek.
- Increase Poe Dam releases and release cooler water to the lower Poe Reach from the Poe Adit.

Remarks:

- There would be power generation loss at the Butt Valley PH and Caribou PH due to reduced releases.
- There would be power generation loss at the Cresta PH if the Cresta Reach temperature measure is increased Cresta Dam release.
- There would be power generation loss at the Bucks Creek PH if the Cresta Reach temperature reduction measure is increased release from Grizzly Forebay/Grizzly Creek.
- There would be power generation loss at the Poe PH due to increased Poe Dam release and cooler water release from the Poe Adit.

4.1.4 Water Temperature Reduction Alternative Category 4: Reduce the temperature in Belden Forebay to 18.0°C combined with additional temperature reduction measures along the lower Belden, Rock Creek, Cresta, and Poe Reaches.

This category includes a combination of measures that would moderately reduce the temperatures of the source waters to the Belden Forebay combined with measures that would reduce temperatures along the lower Belden, Rock Creek, Cresta, and Poe Reaches. No additional measures would be necessary for the upper Belden Reach. This category has three alternatives.

Alternative 4a: Reduce the temperature in Belden Forebay to 18.0°C by installing a thermal curtain at Prattville Intake and a thermal curtain at Butt Valley Reservoir near Caribou PH Intake, with additional temperature reduction measures along the lower Belden, Rock Creek, Cresta, and Poe Reaches. This alternative includes the following measures:

- Install a thermal curtain at the Prattville Intake.
- Install a thermal curtain at Butt Valley Reservoir near the Caribou PH Intakes.

- Convey warm water discharges from the East Branch directly into upper Rock Creek Reservoir.
- Construct a bifurcation berm/wall/partition starting along Yellow Creek extending into Rock Creek Reservoir to separate Yellow Creek flows from Belden PH discharges and Belden Reach flows to prevent mixing, allowing cooler Yellow Creek flows to submerge in Rock Creek Reservoir for release to the Rock Creek Reach, or convey Yellow Creek flows by pipeline to Rock Creek Reservoir for plunging; dredge a submerged channel in Rock Creek Reservoir; and, construct a low level outlet at Rock Creek Dam. Or, alternatively, construct a bypass pipeline to convey cold Yellow Creek flows around Rock Creek Reservoir to the Rock Creek Reach; or alternatively, increase Rock Creek Dam release; or alternatively, construct a mechanical cooling tower/chiller at Rock Creek Dam.
- Construct a low level outlet at Cresta Dam and construct a pipeline to convey all or a portion of the cold Buck Creek PH discharges directly into Cresta Reservoir to avoid mixing with Rock Creek PH discharges, allowing the cold Buck Creek PH flows to submerge in Cresta Reservoir for release to the Cresta Reach. Or, alternatively, increase Cresta Dam release; or alternatively, increase release (to about 130 cfs) of cold water to the Cresta Reach from Grizzly Forebay/Grizzly Creek; or alternatively, construct a mechanical cooling tower/chiller at Cresta Dam.
- Increase Poe Dam release and release cool water to the lower Poe Reach from the Poe Adit; or, alternatively, construct a mechanical cooling tower/chiller at Poe Dam.

Remarks:

- There would be power generation loss at the Rock Creek PH if the Rock Creek Reach temperature measure is increased Rock Creek Dam release.
- There would be power generation loss at the Cresta PH if the Cresta Reach temperature measure is increased Cresta Dam release.
- There would be power generation loss at the Bucks Creek PH if the Cresta Reach temperature reduction measure is increased release from Grizzly Forebay/Grizzly Creek.
- There would be power generation loss at the Poe PH if the Poe Reach temperature reduction measure is increased Poe Dam release and cooler water release from the Poe Adit.

Alternative 4b: This alternative is similar to 4a, except that the measure of installing a thermal curtain at Butt Valley Reservoir near Caribou PH Intake is replaced by preferential use of Caribou PH No.1. This alternative includes the following measures:

- Install a thermal curtain at the Prattville Intake.
- Use Caribou PH No. 1 preferentially over operation of Caribou PH No. 2.
- Convey warm water discharges from the East Branch directly to into upper Rock Creek Reservoir.

- Construct a bifurcation berm/wall/partition starting along Yellow Creek extending into Rock Creek Reservoir to separate Yellow Creek flows from Belden PH discharges and Belden Reach flows to prevent mixing, allowing cooler Yellow Creek flows to submerge in Rock Creek Reservoir for release to the Rock Creek Reach, or convey Yellow Creek flows by pipeline to Rock Creek Reservoir for plunging; dredge a submerged channel in Rock Creek Reservoir; and, construct a low level outlet at Rock Creek Dam. Or, alternatively, construct a bypass pipeline to convey cold Yellow Creek flows around Rock Creek Reservoir to the Rock Creek Reach; or alternatively, increase Rock Creek Dam release; or alternatively, construct a mechanical cooling tower/chiller at Rock Creek Dam.
- Construct a low level outlet at Cresta Dam and construct a pipeline to convey all or a portion of the cold Buck Creek PH discharges directly into Cresta Reservoir to avoid mixing with Rock Creek PH discharges, allowing the cold Buck Creek PH flows to submerge in Cresta Reservoir for release to the Cresta Reach. Or, alternatively, increase Cresta Dam release; or alternatively, increase release (to about 130 cfs) of cold water to the Cresta Reach from Grizzly Forebay/Grizzly Creek; or alternatively, construct a mechanical cooling tower/chiller at Cresta Dam.
- Increase Poe Dam release and release cool water to the lower Poe Reach from the Poe Adit; or, alternatively, construct a mechanical cooling tower/chiller at Poe Dam.

Remarks:

- There would be power generation loss at the Caribou PH complex due to lower turbine efficiency of Caribou PH No.1 relative to Caribou PH No.2. This could be mitigated by constructing a “crossover” conduit connecting Caribou PH No.1 to Caribou PH No.2.
- There would be power generation loss at the Rock Creek PH if the Rock Creek Reach temperature measure is increased Rock Creek Dam release.
- There would be power generation loss at the Cresta PH if the Cresta Reach temperature measure is increased Cresta Dam release.
- There would be power generation loss at the Bucks Creek PH if the Cresta Reach temperature reduction measure is increased release from Grizzly Forebay/Grizzly Creek.
- There would be power generation loss at the Poe PH if the Poe Reach temperature reduction measure is increased Poe Dam release and cooler water release from the Poe Adit.

Alternative 4c: This alternative is similar to 4b except that the measure of installing a thermal curtain at the Prattville Intake is replaced by increasing Canyon Dan release. This alternative includes the following measures:

- Increase Canyon Dam low-level outlet release to about 600 cfs and reduce withdrawal through the Prattville Intake commensurately.
- Use Caribou PH No. 1 preferentially over operation of Caribou PH No. 2.

- Convey warm water discharges from the East Branch directly into upper Rock Creek Reservoir.
- Construct a bifurcation berm/wall/partition starting along Yellow Creek extending into Rock Creek Reservoir to separate Yellow Creek flows from Belden PH discharges and Belden Reach flows to prevent mixing, allowing cooler Yellow Creek flows to submerge in Rock Creek Reservoir for release to the Rock Creek Reach, or convey Yellow Creek flows by pipeline to Rock Creek Reservoir for plunging; dredge a submerged channel in Rock Creek Reservoir; and, construct a low level outlet at Rock Creek Dam. Or, alternatively, construct a bypass pipeline to convey cold Yellow Creek flows around Rock Creek Reservoir to the Rock Creek Reach; or alternatively, increase Rock Creek Dam release; or alternatively, construct a mechanical cooling tower/chiller at Rock Creek Dam.
- Construct a low level outlet at Cresta Dam and construct a pipeline to convey all or a portion of the cold Buck Creek PH discharges directly into Cresta Reservoir to avoid mixing with Rock Creek PH discharges, allowing the cold Bucks Creek PH flows to submerge in Cresta Reservoir for release to the Cresta Reach. Or, alternatively, increase Cresta Dam release; or alternatively, increase release (to about 130 cfs) of cold water to the Cresta Reach from Grizzly Forebay/Grizzly Creek; or alternatively, construct a mechanical cooling tower/chiller at Cresta Dam.
- Increase Poe Dam release and release cool water to the lower Poe Reach from the Poe Adit; or, alternatively, construct a mechanical cooling tower/chiller at Poe Dam.

Remarks:

- There would be power generation loss at the Butt Valley PH and Caribou PH due to reduced releases.
- There would be further power generation loss at the Caribou PH complex due to lower turbine efficiency of Caribou PH No.1 relative to Caribou PH No.2. This could be mitigated by constructing a “crossover” conduit connecting Caribou PH No.1 to Caribou PH No.2.
- There would be power generation loss at the Rock Creek PH if the Rock Creek Reach temperature measure is increased Rock Creek Dam release.
- There would be power generation loss at the Cresta PH if the Cresta Reach temperature measure is increased Cresta Dam release.
- There would be power generation loss at the Bucks Creek PH if the Cresta Reach temperature reduction measure is increased release to Grizzly Creek.
- There would be power generation loss at the Poe PH if the Poe Reach temperature reduction measure is increased Poe Dam release and cooler water release from the Poe Adit.

4.1.5 Water Temperature Reduction Alternative Category 5: Reduce the temperature in Belden Forebay to 19.5°C combined with additional temperature reduction measures along all downstream reaches

This category includes a combination of measures that would slightly reduce the temperatures of the source waters to the Belden Forebay combined with measures that would reduce temperatures along all downstream reaches. This category has three alternatives.

Alternative 5a: Reduce the temperature in Belden Forebay to 19.5°C by preferential use of Caribou PH No.1 plus any needed increased releases from Canyon Dam, and additional temperature reduction measures along all downstream Reaches. This alternative includes the following measures:

- Use Caribou PH No. 1 preferentially over operation of Caribou PH No. 2.
- Increase Canyon Dam low-level outlet release to about 250 cfs or higher and reduce withdrawal through the Prattville Intake commensurately.
- Convey cold water from Seneca Reach directly to Belden Reservoir at an appropriate plunging location and install a thermal curtain near Belden PH Intake; or, alternatively, operate Caribou PHs in strict peaking mode with several hours shut down completely in order for cold water from Seneca Reach to submerge.
- Convey warm water discharges from the East Branch NFFR directly into upper Rock Creek Reservoir.
- Construct a bifurcation berm/wall/partition starting along Yellow Creek extending into Rock Creek Reservoir to separate Yellow Creek flows from Belden PH discharges and Belden Reach flows to prevent mixing, allowing cooler Yellow Creek flows to submerge in Rock Creek Reservoir for release to the Rock Creek Reach, or convey Yellow Creek flows by pipeline to Rock Creek Reservoir for plunging; convey lower Belden Reach flows to Rock Creek Reservoir for plunging; dredge a submerged channel in Rock Creek Reservoir; and, construct a low level outlet at Rock Creek Dam. Or, alternatively, construct a bypass pipeline to convey cold Yellow Creek/Chips Creek flows around Rock Creek Reservoir to the Rock Creek Reach; or alternatively, construct a mechanical cooling tower/chiller at Rock Creek Dam.
- Construct a low level outlet at Cresta Dam and construct a pipeline to convey all or a portion of the cold Buck Creek PH discharges directly into Cresta Reservoir to avoid mixing with Rock Creek PH discharges, allowing the cold Buck Creek PH flows to submerge in Cresta Reservoir for release to the Cresta Reach; and, dredge a submerged channel in Cresta Reservoir. Or, alternatively, increase release (to about 150 cfs) of cold water to the Cresta Reach from Grizzly Forebay/Grizzly Creek; or alternatively, construct a mechanical cooling tower/chiller at Cresta Dam.
- Construct a mechanical cooling tower/chiller at Poe Dam.

Remarks:

- There would be power generation loss at the Butt Valley PH and Caribou PH due to reduced releases.
- There would be further power generation loss at the Caribou PH complex due to lower turbine efficiency of Caribou PH No.1 relative to Caribou PH No.2. This could be mitigated by constructing a “crossover” conduit connecting Caribou PH No.1 to Caribou PH No.2.
- There would be power generation loss at the Bucks Creek PH if the Cresta Reach temperature reduction measure is increased release from Grizzly Forebay/Grizzly Creek.

Alternative 5b: This alternative is similar to 5a, except that the measure of preferential use of Caribou PH No. 1 is replaced by installing a thermal curtain near Caribou PH Intake. This alternative includes the following measures:

- Install a thermal curtain at Butt Valley Reservoir near Caribou PH Intake.
- Increase Canyon Dam low-level outlet release to about 250 cfs or higher and reduce withdrawal through the Prattville Intake commensurately.
- Convey cold water from Seneca Reach directly to Belden Reservoir at an appropriate plunging location and install a thermal curtain near Belden PH Intake; or, alternatively, operate Caribou PHs in strict peaking mode with several hours shut down completely in order for cold water from Seneca Reach to submerge.
- Convey warm water discharges from the East Branch directly into upper Rock Creek Reservoir.
- Construct a bifurcation berm/wall/partition starting along Yellow Creek extending into Rock Creek Reservoir to separate Yellow Creek flows from Belden PH discharges and Belden Reach flows to prevent mixing, allowing cooler Yellow Creek flows to submerge in Rock Creek Reservoir for release to the Rock Creek Reach, or convey Yellow Creek flows by pipeline to Rock Creek Reservoir for plunging; convey lower Belden Reach flows to Rock Creek Reservoir for plunging; dredge a submerged channel in Rock Creek Reservoir; and, construct a low level outlet at Rock Creek Dam. Or, alternatively, construct a bypass pipeline to convey cold Yellow Creek/Chips Creek flows around Rock Creek Reservoir to the Rock Creek Reach; or alternatively, construct a mechanical cooling tower/chiller at Rock Creek Dam.
- Construct a low level outlet at Cresta Dam and construct a pipeline to convey all or a portion of the cold Buck Creek PH discharges directly into Cresta Reservoir to avoid mixing with Rock Creek PH discharges, allowing the cold Buck Creek PH flows to submerge in Cresta Reservoir for release to the Cresta Reach; and, dredge a submerged channel in Cresta Reservoir. Or, alternatively, increase release (to about 150 cfs) of cold water to the Cresta Reach from Grizzly Forebay/Grizzly Creek; or alternatively, construct a mechanical cooling tower/chiller at Cresta Dam.
- Construct a mechanical cooling tower/chiller at Poe Dam.

Remarks:

- There would be power generation loss at the Butt Valley PH and Caribou PH due to reduced releases.
- There would be power generation loss at the Bucks Creek PH if the Cresta Reach temperature reduction measure is increased release from Grizzly Forebay/Grizzly Creek.

Alternative 5c: This alternative is similar to 5a, except that the measure of preferential use of Caribou PH No. 1 is replaced by conveying Butt Valley PH discharges by pipeline to Butt Valley Reservoir near Caribou PH Intakes. This alternative includes the following measures:

- Construct about five miles of pipeline laid along the bed of Butt Valley Reservoir for conveying Butt Valley PH discharges to Butt Valley Reservoir near Caribou PH Intake.
- Increase Canyon Dam low-level outlet release to about 250 cfs or higher and reduce withdrawal through the Prattville Intake commensurately.
- Convey cold water from Seneca Reach directly to Belden Reservoir at an appropriate plunging location and install a thermal curtain near Belden PH Intake; or, alternatively, operate Caribou PHs in strict peaking mode with several hours shut down completely in order for cold water from Seneca Reach to submerge.
- Convey warm water discharges from the East Branch directly into upper Rock Creek Reservoir.
- Construct a bifurcation berm/wall/partition starting along Yellow Creek extending into Rock Creek Reservoir to separate Yellow Creek flows from Belden PH discharges and Belden Reach flows to prevent mixing, allowing cooler Yellow Creek flows to submerge in Rock Creek Reservoir for release to the Rock Creek Reach, or convey Yellow Creek flows by pipeline to Rock Creek Reservoir for plunging; convey lower Belden Reach flows to Rock Creek Reservoir for plunging; dredge a submerged channel in Rock Creek Reservoir; and, construct a low level outlet at Rock Creek Dam. Or, alternatively, construct a bypass pipeline to convey cold Yellow Creek/Chips Creek flows around Rock Creek Reservoir to the Rock Creek Reach; or alternatively, construct a mechanical cooling tower/chiller at Rock Creek Dam.
- Construct a low level outlet at Cresta Dam and construct a pipeline to convey all or a portion of the cold Buck Creek PH discharges directly into Cresta Reservoir to avoid mixing with Rock Creek PH discharges, allowing the cold Buck Creek PH flows to submerge in Cresta Reservoir for release to the Cresta Reach; and, dredge a submerged channel in Cresta Reservoir. Or, alternatively, increase release (to about 150 cfs) of cold water to the Cresta Reach from Grizzly Forebay/Grizzly Creek; or alternatively, construct a mechanical cooling tower/chiller at Cresta Dam.
- Construct a mechanical cooling tower/chiller at Poe Dam.

Remarks:

- There would be power generation loss at the Butt Valley PH and Caribou PH due to reduced releases.

- There would be power generation loss at the Bucks Creek PH if the Cresta Reach temperature reduction measure is increased release from Grizzly Forebay/Grizzly Creek.

4.1.6 Water Temperature Reduction Alternative Category 6: Reduce temperatures in all downstream reaches

This category includes a combination of measures that would focus on temperature reduction in the downstream reaches, and does not necessarily require measures at Lake Almanor and Butt Valley Reservoir. This category has three alternatives.

Alternative 6a: Reduce temperatures in all downstream reaches by increasing Canyon Dam cold water release from the low level outlet and bypassing this cold water to all downstream reaches. This alternative includes the following measures:

- Increase Canyon Dam release to 250 cfs from the low level outlet.
- Construct a pipeline to convey cold Seneca Reach flows to Belden Reservoir for plunging or around Belden Reservoir to the Belden Reach and convey warm water discharges from the East Branch NFFR directly into upper Rock Creek Reservoir.
- Construct a bypass pipeline to convey cold Belden Reach flows (originating from Seneca Reach) from upstream of the East Branch and around Rock Creek Reservoir to the Rock Creek Reach.
- Construct a bypass pipeline to convey cold Rock Creek Reach flows (originating from Seneca Reach) around Cresta Reservoir to the Cresta Reach.
- Construct a bypass pipeline to convey cold Cresta Reach flows (originating from Seneca Reach) around Cresta Reservoir to the Poe Reach.

Remarks:

- There would be power generation loss at the Butt Valley PH and Caribou PHs due to reduced releases.

Alternative 6b: Reduce temperatures in all downstream reaches (except for the Belden Reach) by constructing a mechanical cooling tower/chiller at each dam. This alternative includes the following measures:

- Increase Canyon Dam low-level outlet release to 90 cfs or higher and reduce withdrawal through the Prattville Intake commensurately.
- Operate Caribou PHs in strict peaking mode with several hours shut down completely in order for cold water from Seneca Reach to submerge.
- Construct a mechanical cooling tower/chiller at Rock Creek Dam.
- Construct a mechanical cooling tower/chiller at Cresta Dam.

- Construct a mechanical cooling tower/chiller at Poe Dam.

Alternative 6c: Reduce temperatures in all downstream reaches by discharging cold water to the reaches from a delivery system that conveys cold water pumped from Lake Oroville.

- Construct a water delivery system that draws cold water from depth at Lake Oroville and delivers it to a discharge point below each NFFR dam starting upstream at Belden Dam and infusing to the Belden, Rock Creek, Cresta and Poe reaches.

Table 4-1 Initial Level 1 Alternatives to Achieve the 20°C Objective Target for Water Temperature along the NFFR

Alternative Category	Alternative		Variations for Cooling Downstream Reaches			
	Alt.	Measures in reducing source water temperature to Belden Forebay	Additional measures for Belden Reach	Additional measures for Rock Creek Reach	Additional measures for Cresta Reach	Additional measures for Poe Reach
1. Reduce the temperature in Belden Forebay to 12.5 °C. (1 variation)	1	<ul style="list-style-type: none"> Install Prattville thermal curtain with levee removed Collect and convey cold spring water (215 cfs, 8°C) to Prattville Intake Convey Butt Valley PH discharges to Butt Valley Reservoir near Caribou Intake 	No	No	No	No
2. Reduce the temperature in Belden Forebay to 14.5 °C. (9 variations)	2a	<ul style="list-style-type: none"> Install Prattville thermal curtain with levee removed Convey Butt Valley PH discharges to Butt Valley Reservoir near Caribou Intake 	No	No	No	<ul style="list-style-type: none"> Increase shading along Poe Reach
	2b	<ul style="list-style-type: none"> Install Prattville thermal curtain with levee removed Install a thermal curtain near Caribou Intake in Butt Valley Reservoir Collect and convey cold spring water (215 cfs, 8°C) to Prattville Intake 				<ul style="list-style-type: none"> Increase Poe Dam release
	2c	<ul style="list-style-type: none"> Decrease Prattville Intake release to cause cold water selective withdrawal Extend the existing deeper channel of Butt Valley Reservoir by dredging Use Caribou #1 exclusively with reduced release to cause cold water selective withdrawal Repair/modify Canyon Dam low level outlet and increase release to 600 cfs 				<ul style="list-style-type: none"> Construct outlet/pipeline from the Poe Adit and release the cooler water to the Poe Reach
3. Reduce the temperature in Belden Forebay to 16.0 °C. (2 variations)	3	<ul style="list-style-type: none"> Install Prattville thermal curtain with levee removed Install a thermal curtain near Caribou Intake in Butt Valley Reservoir Increase Canyon Dam release as needed (and decrease Prattville Intake release commensurately) 	<ul style="list-style-type: none"> Convey warm water in East Branch NFFR to Rock Creek Reservoir by diversion/pipeline <p>Note: This measure is designed to protect the lower Belden Reach.</p>	No	<ul style="list-style-type: none"> Increase Cresta Dam release 	<ul style="list-style-type: none"> Increase Poe Dam release Construct outlet/pipeline from the Poe Adit and release the cooler water to the Poe Reach
				<ul style="list-style-type: none"> Increase Grizzly Creek Release 		

Note: To explain how the number of variations is determined, take Alternative Category 2 as an example: Alternative Category 2 has three alternatives (2a, 2b, and 2c) and three variations for the Poe Reach, totaling 9 alternatives with variations (i.e., 3 × 3 = 9).

Table 4-1 Initial Level 1 Alternatives to Achieve the 20°C Objective Target for Water Temperature along the NFFR (Cont'd)

Alternative Category	Alternative		Variations for Cooling Downstream Reaches				
	Alt.	Measures in reducing source water temperature to Belden Forebay	Additional measures for Belden Reach	Additional measures for Rock Creek Reach	Additional measures for Cresta Reach	Additional measures for Poe Reach	
4. Reduce the temperature in Belden Forebay to 18.0 °C. (120 variations)	4a	<ul style="list-style-type: none"> Install Prattville thermal curtain Install a thermal curtain near Caribou Intake in Butt Valley Reservoir 	<ul style="list-style-type: none"> Convey warm water in East Branch NFFR to Rock Creek Reservoir by diversion/pipeline <p>Note: This measure is designed to protect the lower Belden Reach.</p>	<ul style="list-style-type: none"> Construct Yellow Creek/ Belden PH bifurcation or, convey Yellow Creek flows by pipeline to Rock Creek Reservoir for plunging Construct low level outlet at Rock Creek Dam Dredge a submerged channel in Rock Creek Reservoir 	<ul style="list-style-type: none"> Convey cold Bucks Creek PH flows to Cresta Reservoir for plunging by pipeline Construct low level outlet at Cresta Dam 	<ul style="list-style-type: none"> Increase Poe Dam release Construct outlet/pipeline from the Poe Adit and release the cooler water to the Poe Reach 	
	4b	<ul style="list-style-type: none"> Install Prattville thermal curtain Use Caribou #1 preferentially over Caribou #2 		<ul style="list-style-type: none"> Bypass Yellow Creek flows around Rock Creek Reservoir by diversion/pipeline 	<ul style="list-style-type: none"> Bypass cold Bucks Creek PH flows around Cresta Reservoir by diversion/pipeline 		
	4c	<ul style="list-style-type: none"> Repair/modify Canyon Dam low level outlet and increase release to 600 cfs (and decrease Prattville Intake release commensurately) Use Caribou #1 preferentially 		<ul style="list-style-type: none"> Increase Rock Creek Dam release 	<ul style="list-style-type: none"> Increase Cresta Dam release Increase Grizzly Creek releases to about 130 cfs 		
5. Reduce the temperature in Belden Forebay to 19.5 °C. (72 variations)	5a	<ul style="list-style-type: none"> Use Caribou #1 preferentially over Caribou #2 Repair/modify Canyon Dam low level outlet and increase release to 250 cfs or higher (and decrease Prattville Intake release commensurately) 	<ul style="list-style-type: none"> Convey cold Seneca Reach flows to Belden Reservoir for plunging by diversion/pipeline Install a thermal curtain near Belden PH Intake Convey warm water in East Branch NFFR to Rock Creek Reservoir by diversion/pipeline 	<ul style="list-style-type: none"> Construct Yellow Creek/ Belden PH bifurcation or, convey Yellow Creek flows by pipeline to Rock Creek Reservoir for plunging Convey lower Belden Reach flows to Rock Creek Reservoir for plunging Dredge a submerged channel in Rock Creek Reservoir Construct low level outlet at Rock Creek Dam 	<ul style="list-style-type: none"> Convey cold Bucks Creek PH flows to Cresta Reservoir for plunging by diversion/pipeline Dredge a submerged channel in Cresta Reservoir Construct low level outlet at Cresta Dam 	<ul style="list-style-type: none"> Construct water chiller at Poe Dam 	
	5b	<ul style="list-style-type: none"> Install thermal curtain near Caribou Intake in Butt Valley Reservoir Repair/modify Canyon Dam low level outlet and increase release to 250 cfs or higher (and decrease Prattville Intake release commensurately) 		<ul style="list-style-type: none"> Operate Caribou PHs in strict peaking mode with several hours shut down Convey warm water in East Branch NFFR to Rock Creek Reservoir by diversion/pipeline 	<ul style="list-style-type: none"> Bypass Yellow Creek/Chips Creek flows around Rock Creek Reservoir by diversion/pipeline 		<ul style="list-style-type: none"> Increase Grizzly Creek releases to about 150 cfs
	5c	<ul style="list-style-type: none"> Convey Butt Valley PH discharges by pipeline to Butt Valley Reservoir near the Caribou Intake Repair/modify Canyon Dam low level outlet and increase release to 250 cfs or higher (and decrease Prattville Intake release commensurately) 			<ul style="list-style-type: none"> Construct water chiller at Rock Creek Dam 		<ul style="list-style-type: none"> Construct water chiller at Cresta Dam

Table 4-1 Initial Level 1 Alternatives to Achieve the 20°C Objective Target for Water Temperature along the NFFR (Cont'd)

Alternative Category	Alternative		Variations for Cooling Downstream Reaches			
	Alt.	Measures in reducing source water temperature to Belden Forebay	Additional measures for Belden Reach	Additional measures for Rock Creek Reach	Additional measures for Cresta Reach	Additional measures for Poe Reach
6. Reduce temperatures in all downstream reaches. (3 variations)	6a	No	<ul style="list-style-type: none"> Repair/modify Canyon Dam low level outlet and increase release to 250 cfs Convey cold Seneca Reach flows to Belden Reservoir for plunging or around Belden Reservoir by diversion/pipeline Convey warm water in East Branch NFFR to Rock Creek Reservoir by diversion/pipeline 	<ul style="list-style-type: none"> Bypass lower Belden Reach flows around Rock Creek Reservoir by diversion/pipeline <p>Note: Must be combined with bypassing Seneca flows around Belden Reservoir.</p>	<ul style="list-style-type: none"> Bypass lower Rock Creek Reach flows around Cresta Reservoir by diversion/pipeline <p>Note: Must be combined with bypassing Seneca flows around Belden Reservoir.</p>	<ul style="list-style-type: none"> Bypass lower Cresta Reach flows around Poe Reservoir by diversion/ pipeline <p>Note: Must be combined with bypassing Seneca flows around Belden Reservoir.</p>
	6b		<ul style="list-style-type: none"> Increase Canyon Dam low level outlet release to 90 cfs or higher Operate Caribou PHs in strict peaking mode with several hours shut down Convey warm water in East Branch NFFR to Rock Creek Reservoir by diversion/pipeline 	<ul style="list-style-type: none"> Construct water chiller at Rock Creek Dam 	<ul style="list-style-type: none"> Construct water chiller at Cresta Dam 	<ul style="list-style-type: none"> Construct water chiller at Poe Dam
	6c		<ul style="list-style-type: none"> Convey cold water from Lake Oroville to below Belden Dam 	<ul style="list-style-type: none"> Convey cold water from Lake Oroville to below Rock Creek Dam 	<ul style="list-style-type: none"> Convey cold water from Lake Oroville to below Cresta Dam 	<ul style="list-style-type: none"> Convey cold Lake Oroville to below Poe D.

Notes:

- 1) Water temperature reduction Alternative 6a is created by combining the measures in the first row. Accordingly, Alternative 6a has only one alternative and variation.
- 2) Water temperature reduction Alternative 6b is created by combining the measures in the second row. Accordingly, Alternative 6b has only one alternative and variation.
- 3) Water temperature reduction Alternative 6c is created by combining the measures in the third row. Accordingly, Alternative 6c has only one alternative and variation.

4.2 SCREENING OF INITIAL LEVEL 1 WATER TEMPERATURE REDUCTION ALTERNATIVES AND FINAL LEVEL 1 WATER TEMPERATURE REDUCTION ALTERNATIVES

As shown on Table 4-1, more than 200 alternative variations were available for consideration at the onset of the Level 1 evaluation. The State Water Board recognized that the wide array of choices offered in Level 1 would inhibit the ability to fully develop a reasonable range of CEQA alternatives. To focus efforts of the alternative development process on the most promising variations, the initial Level 1 water temperature reduction alternatives were subjected to the following coarse screening criteria:

- Effectiveness and reliability – Is there a reasonable potential that the alternative can effectively and reliably achieve the preliminary temperature target or, is the effectiveness and reliability of the alternative overly speculative?
- Technological feasibility and constructability – Can the alternative be implemented with currently available technology and construction methods?
- Logistics – Can the alternative be implemented when considering current legal obligations, regulatory permitting requirements, public safety needs, right-of-way and access needs, and other real world logistical constraints?
- Reasonability²⁵ – Are there clearly more reasonable or superior alternatives available based on the other criteria? Is implementation of the alternative remote or highly speculative?

The initial screening resulted in the elimination of certain alternatives. Justifications are described below:

Elimination of Alternative Category 1 (Alternative 1) and Alternative 2b

Alternative 1 and Alternative 2b rely on the substantial temperature reduction at the Butt Valley PH discharge by constructing an expansive, high-capacity wellfield that would pump cold water directly from the basalt aquifer discharging to Big Springs/northeastern Lake Almanor. This measure would, in theory, effectively reduce Butt Valley PH discharge temperature as required in Alternative 1. The hydrologic budget analysis of Lake Almanor suggests that Big Springs and related cold springs discharge up to 400 cfs into the lake on average; however, very little detailed information is available on the hydrogeology and developmental potential of the basalt aquifer supplying this cold water discharge. Extensive field investigation would be required to evaluate the feasibility and reliability of this alternative. Accordingly, this measure was eliminated based on the reasonability criterion because its effectiveness and implementation are remote and speculative. Consequently, Alternatives 1 and 2b, which rely on this wellfield measure, were eliminated.

Elimination of Alternative 6c

Alternative 6c relies on temperature reduction in the downstream reaches without drawing any cold water from Lake Almanor. Instead, this alternative cools the NFFR

²⁵ An EIR need not consider an alternative whose effect cannot be reasonably ascertained and whose implementation is remote and speculative (CEQA Guidelines, § 15126, subd. (d)).

reaches downstream of Belden Dam by constructing an expensive water delivery system that pumps cold water drawing from depth at Lake Oroville and delivers it to discharge points below each dam. This measure would, in theory, effectively reduce water temperature in each reach as required. However, the real world logistical considerations of withdrawing cold water from FERC Project 2100 could cause this measure to be dismissed. This measure would be extremely costly, in terms of construction cost and energy cost for pumping. Accordingly, this alternative was eliminated based on the reasonability criterion because there are clearly superior and more reasonable alternatives available and its implementation is remote.

The final Level 1 alternatives are summarized in Table 4-2. These alternatives are advanced for further analyses and evaluation in the Level 2 water temperature reduction alternatives screening process, detailed in Chapter 5. The “Alternative Development and Evaluation Process Flow Diagram”, updated to reflect the results of Level 1 screening, is presented in Figure 4-1.

Table 4-2 Final Level 1 Alternatives to Achieve the 20°C Objective Target for Water Temperature along the NFFR
(Level 1 screening eliminations identified by “strikeout”)

Alternative Category	Alternative		Variations for Cooling Downstream Reaches			
	Alt.	Measures in reducing source water temperature to Belden Forebay	Additional measures for Belden Reach	Additional measures for Rock Creek Reach	Additional measures for Cresta Reach	Additional measures for Poe Reach
1. Reduce the temperature in Belden Forebay to 12.5 °C.	X	<ul style="list-style-type: none"> Install Prattville thermal curtain with levee removed Collect and convey cold spring water (215 cfs, 8°C) to Prattville Intake Convey Butt Valley PH discharges to Butt Valley Reservoir near Caribou Intake 	No	No	No	No
2. Reduce the temperature in Belden Forebay to 14.5 °C. (6 variations)	2a	<ul style="list-style-type: none"> Install Prattville thermal curtain with levee removed Convey Butt Valley PH discharges to Butt Valley Reservoir near Caribou Intake 	No	No	No	<ul style="list-style-type: none"> Increase shading along Poe Reach
	2b	<ul style="list-style-type: none"> Install Prattville thermal curtain with levee removed Install a thermal curtain near Caribou Intake in Butt Valley Reservoir Collect and convey cold spring water (215 cfs, 8°C) to Prattville Intake 				<ul style="list-style-type: none"> Increase Poe Dam release
	2c	<ul style="list-style-type: none"> Decrease Prattville Intake release to cause cold water selective withdrawal Extend the existing deeper channel of Butt Valley Reservoir by dredging Use Caribou #1 exclusively with reduced release to cause cold water selective withdrawal Repair/modify Canyon Dam low level outlet and increase release to 600 cfs 				<ul style="list-style-type: none"> Construct outlet/pipeline from the Poe Adit and release the cooler water to the Poe Reach
3. Reduce the temperature in Belden Forebay to 16.0 °C. (2 variations)	3	<ul style="list-style-type: none"> Install Prattville thermal curtain with levee removed Install a thermal curtain near Caribou Intake in Butt Valley Reservoir Increase Canyon Dam release as needed (and decrease Prattville Intake release commensurately) 	<ul style="list-style-type: none"> Convey warm water in East Branch NFFR to Rock Creek Reservoir by diversion/pipeline <p>Note: This measure is designed to protect the lower Belden Reach.</p>	No	<ul style="list-style-type: none"> Increase Cresta Dam release Increase Grizzly Creek Release 	<ul style="list-style-type: none"> Increase Poe Dam release Construct outlet/pipeline from the Poe Adit and release the cooler water to the Poe Reach

Note: To explain how the number of variations is determined, take Alternative Category 2 as an example: Alternative Category 2 has two alternatives (2a and 2c) and three variations for the Poe Reach, totaling 6 alternatives with variations (i.e., 2 × 3 = 6).

Table 4-2 Final Level 1 Alternatives to Achieve the 20°C Objective Target for Water Temperature along the NFFR(Cont'd)

Alternative Category	Alternative		Variations for Cooling Downstream Reaches			
	Alt.	Measures in reducing source water temperature to Belden Forebay	Additional measures for Belden Reach	Additional measures for Rock Creek Reach	Additional measures for Cresta Reach	Additional measures for Poe Reach
4. Reduce the temperature in Belden Forebay to 18.0 °C. (120 variations)	4a	<ul style="list-style-type: none"> Install Prattville thermal curtain Install a thermal curtain near Caribou Intake in Butt Valley Reservoir 	<ul style="list-style-type: none"> Convey warm water in East Branch NFFR to Rock Creek Reservoir by diversion/pipeline <p>Note: This measure is designed to protect the lower Belden Reach.</p>	<ul style="list-style-type: none"> Construct Yellow Creek/ Belden PH bifurcation or, convey Yellow Creek flows by pipeline to Rock Creek Reservoir for plunging Construct low level outlet at Rock Creek Dam Dredge a submerged channel in Rock Creek Reservoir 	<ul style="list-style-type: none"> Convey cold Bucks Creek PH flows to Cresta Reservoir for plunging by pipeline Construct low level outlet at Cresta Dam 	<ul style="list-style-type: none"> Increase Poe Dam release Construct outlet/pipeline from the Poe Adit and release the cooler water to the Poe Reach
	4b	<ul style="list-style-type: none"> Install Prattville thermal curtain Use Caribou #1 preferentially over Caribou #2 		<ul style="list-style-type: none"> Bypass Yellow Creek flows around Rock Creek Reservoir by diversion/pipeline 	<ul style="list-style-type: none"> Bypass cold Bucks Creek PH flows around Cresta Reservoir by diversion/pipeline 	
	4c	<ul style="list-style-type: none"> Repair/modify Canyon Dam low level outlet and increase release to 600 cfs (and decrease Prattville Intake release commensurately) Use Caribou #1 preferentially 		<ul style="list-style-type: none"> Increase Rock Creek Dam release 	<ul style="list-style-type: none"> Increase Cresta Dam release Increase Grizzly Creek releases to about 130 cfs 	
		<ul style="list-style-type: none"> Construct water chiller at Rock Creek Dam 	<ul style="list-style-type: none"> Construct water chiller at Cresta Dam 			
5. Reduce the temperature in Belden Forebay to 19.5 °C. (72 variations)	5a	<ul style="list-style-type: none"> Use Caribou #1 preferentially over Caribou #2 Repair/modify Canyon Dam low level outlet and increase release to 250 cfs or higher (and decrease Prattville Intake release commensurately) 	<ul style="list-style-type: none"> Convey cold Seneca Reach flows to Belden Reservoir for plunging by diversion/pipeline Install a thermal curtain near Belden PH Intake Convey warm water in East Branch NFFR to Rock Creek Reservoir by diversion/pipeline 	<ul style="list-style-type: none"> Construct Yellow Creek/ Belden PH bifurcation or, convey Yellow Creek flows by pipeline to Rock Creek Reservoir for plunging Convey lower Belden Reach flows to Rock Creek Reservoir for plunging Dredge a submerged channel in Rock Creek Reservoir Construct low level outlet at Rock Creek Dam 	<ul style="list-style-type: none"> Convey cold Bucks Creek PH flows to Cresta Reservoir for plunging by diversion/pipeline Dredge a submerged channel in Cresta Reservoir Construct low level outlet at Cresta Dam 	<ul style="list-style-type: none"> Construct water chiller at Poe Dam
	5b	<ul style="list-style-type: none"> Install thermal curtain near Caribou Intake in Butt Valley Reservoir Repair/modify Canyon Dam low level outlet and increase release to 250 cfs or higher (and decrease Prattville Intake release commensurately) 	<ul style="list-style-type: none"> Operate Caribou PHs in strict peaking mode with several hours shut down Convey warm water in East Branch NFFR to Rock Creek Reservoir by diversion/pipeline 	<ul style="list-style-type: none"> Bypass Yellow Creek/Chips Creek flows around Rock Creek Reservoir by diversion/pipeline 	<ul style="list-style-type: none"> Increase Grizzly Creek releases to about 150 cfs 	
	5c	<ul style="list-style-type: none"> Convey Butt Valley PH discharges by pipeline to Butt Valley Reservoir near the Caribou Intake Repair/modify Canyon Dam low level outlet and increase release to 250 cfs or higher (and decrease Prattville Intake release commensurately) 		<ul style="list-style-type: none"> Construct water chiller at Rock Creek Dam 	<ul style="list-style-type: none"> Construct water chiller at Cresta Dam 	

Table 4-2 Final Level 1 Alternatives to Achieve the 20°C Objective Target for Water Temperature along the NFFR (Cont'd)

Alternative Category	Alternative		Variations for Cooling Downstream Reaches			
	Alt.	Measures in reducing source water temperature to Belden Forebay	Additional measures for Belden Reach	Additional measures for Rock Creek Reach	Additional measures for Cresta Reach	Additional measures for Poe Reach
6. Reduce temperatures in all downstream reaches. (2 variations)	6a	No	<ul style="list-style-type: none"> Repair/modify Canyon Dam low level outlet and increase release to 250 cfs Convey cold Seneca Reach flows to Belden Reservoir for plunging or around Belden Reservoir by diversion/pipeline Convey warm water in East Branch NFFR to Rock Creek Reservoir by diversion/pipeline 	<ul style="list-style-type: none"> Bypass lower Belden Reach flows around Rock Creek Reservoir by diversion/pipeline <p>Note: Must be combined with bypassing Seneca flows around Belden Reservoir.</p>	<ul style="list-style-type: none"> Bypass lower Rock Creek Reach flows around Cresta Reservoir by diversion/pipeline <p>Note: Must be combined with bypassing Seneca flows around Belden Reservoir.</p>	<ul style="list-style-type: none"> Bypass lower Cresta Reach flows around Poe Reservoir by diversion/ pipeline <p>Note: Must be combined with bypassing Seneca flows around Belden Reservoir.</p>
	6b		<ul style="list-style-type: none"> Increase Canyon Dam low level outlet release to 90 cfs or higher Operate Caribou PHs in strict peaking mode with several hours shut down Convey warm water in East Branch NFFR to Rock Creek Reservoir by diversion/pipeline 	<ul style="list-style-type: none"> Construct water chiller at Rock Creek Dam 	<ul style="list-style-type: none"> Construct water chiller at Cresta Dam 	<ul style="list-style-type: none"> Construct water chiller at Poe Dam
	6c		<ul style="list-style-type: none"> Convey cold water from Lake Oroville to below Belden Dam 	<ul style="list-style-type: none"> Convey cold water from Lake Oroville to below Rock Creek Dam 	<ul style="list-style-type: none"> Convey cold water from Lake Oroville to below Cresta Dam 	<ul style="list-style-type: none"> Convey cold Lake Oroville to below Poe D.

Notes:

- 1) Water temperature reduction Alternative 6a is created by combining the measures in the first row. Accordingly, Alternative 6a has only one alternative and variation.
- 2) Water temperature reduction Alternative 6b is created by combining the measures in the second row. Accordingly, Alternative 6b has only one alternative and variation.

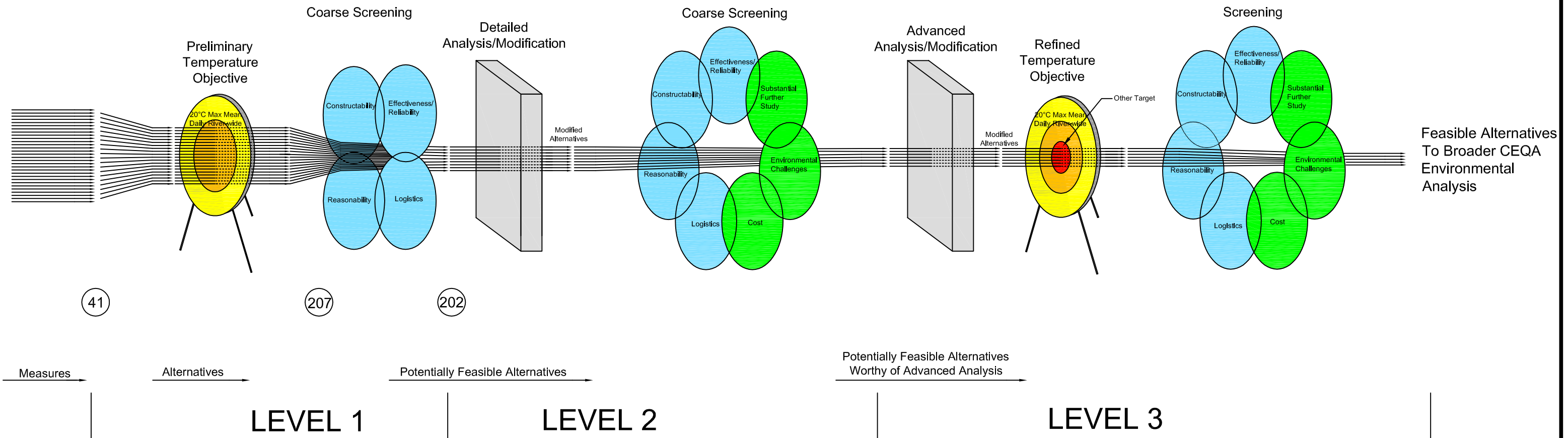


Figure 4-1

Upper North Fork Feather River: Alternatives Development and Evaluation Process Flow Diagram and Resulting Number of Alternatives in Level 1

5.0 LEVEL 2 ANALYSIS OF WATER TEMPERATURE REDUCTION ALTERNATIVES

This chapter describes the Level 2 analysis of water temperature reduction alternatives that passed Level 1 screening (as summarized in Chapter 4, Table 4-2). The analysis included further study of effectiveness in reducing water temperatures and achieving the temperature target along the NFFR, refinement of the alternatives, and preparation of rough design layouts, cost estimates and operational requirements. Based on this information, the initial Level 2 water temperature reduction alternatives were then screened by applying the same criteria used in Level 1 (refer to Section 4.2, p. 4-17) plus the following additional criteria:

- Substantial Further Study - Is there sufficient information currently available or can it be readily developed in order to evaluate the potential effectiveness and
- feasibility of the alternative, or is substantial further investigation or study required?
- Environmental challenges – Are there obvious environmental consequences or problems associated with the alternative that would pose a major challenge to overcome?
- Economic feasibility – Can the alternative be implemented at a reasonable cost, including capital, O&M, and considering energy replacement costs?

The resulting water temperature reduction alternatives passing Level 2 screening represent *the set of potentially effective and feasible* alternatives to achieving the temperature target and are recommended for final detailed technical analysis in Level 3.

5.1 INITIAL LEVEL 2 WATER TEMPERATURE REDUCTION ALTERNATIVES -- DESIGN LAYOUTS, OPERATIONAL REQUIREMENTS, COST ESTIMATES, AND EFFECTIVENESS

Descriptions for the initial Level 2 water temperature reduction alternatives generally follow those provided in Chapter 4 (refer to section 4.1; Table 4-2), with some refinements based on more detailed modeling analysis of effectiveness in reducing water temperatures in Level 2. The refinements offer several new variations, focusing primarily on changes in hydroelectric facility operations. These new variations increased the number of alternatives from 202 to 370, and are shown in bold font in Table 5-1²⁶. This formatting is carried forward in subsequent tables.

Illustrative layouts for selected alternatives are presented in Figures 5-1 through 5-7. Each figure also includes a table summarizing the estimated cost of the alternative and a graph showing the resulting water temperature profile along the NFFR. Because it was not practical to prepare figures for all the alternatives and possible variations listed in Table 5-1 (370 variations), figures were prepared only for selected alternatives covering a range of alternatives and variations. These figures illustrate how water temperature measures have been combined to create

²⁶ As a result of refinement of the alternatives, flow-related measures were added for the Rock Creek, Cresta, and Poe downstream reaches, creating additional variations for the Category 5 alternatives (not previously explored in Level 1).

comprehensive water temperature reduction alternatives to decrease water temperature and meet the temperature target of 20°C mean daily along the entire NFFR.

The following alternatives with variations were available at the beginning of the Level 2 evaluation (i.e., initial Level 2 water temperature reduction alternatives).

- Alternative Category 2 – two alternatives (Alternatives 2a & 2c) with three variations for the Poe Reach, totaling 6 alternative variations (i.e., $2 \times 3 = 6$).
- Alternative Category 3 – one alternative (Alternative 3) with one variation for the Belden Reach, two variations for the Cresta Reach, and one variation for the Poe Reach, totaling 2 alternative variations (i.e., $1 \times 1 \times 2 \times 1 = 2$).
- Alternative Category 4 – three alternatives (Alternatives 4a, 4b, and 4c) with one variation for the Belden Reach, four variations for the Rock Creek Reach, five variations for the Cresta Reach, and two variations for the Poe Reach, totaling 120 alternative variations (i.e., $3 \times 1 \times 4 \times 5 \times 2 = 120$).
- Alternative Category 5 – three alternatives (Alternatives 5a, 5b & 5c) with two variations for the Belden Reach, four variations for the Rock Creek Reach, five variations for the Cresta Reach, and two variations for the Poe Reach, totaling 240 alternative variations (i.e., $3 \times 2 \times 4 \times 5 \times 2 = 240$).
- Alternative Category 6 – two alternatives (Alternatives 6a & 6b), 2 variations²⁷.

Cost tables for all initial Level 2 water temperature reduction alternatives are presented by category in Tables 5-2a through 5-2e. The cost estimates derive from the design layouts and detailed descriptions of the individual water temperature reduction measures that comprise the water temperature reduction alternatives. These descriptions include narratives, rough engineering designs and cost estimates, key design or construction uncertainties, and discussions (refer to Appendix E for detailed information about engineering designs and cost estimates for these individual water temperature reduction measures). The effectiveness of each alternative in reducing temperatures and achieving the temperature target was analyzed following the same method used in Level 1, with the addition in Level 2 of detailed stream water temperature modeling and water temperature mixing analysis (refer to Chapter 3).

²⁷ See the notes under Alternative Category 6 of Table 5-1.

Table 5-1 Initial Level 2 Alternatives to Achieve the 20°C Objective Target for Water Temperature along the NFFR

(Note: **bold** denotes refinement to final Level 1 alternative)

Alternative Category	Alternative		Variations for Cooling Downstream Reaches			
	Alt.	Measures in reducing source water temperature to Belden Forebay	Additional measures for Belden Reach	Additional measures for Rock Creek Reach	Additional measures for Cresta Reach	Additional measures for Poe Reach
2. Reduce the temperature in Belden Forebay to 14.5 °C. (6 variations)	2a	<ul style="list-style-type: none"> Install Prattville thermal curtain with levee removed Convey Butt Valley PH discharges to 2,000 cfs to Butt Valley Reservoir near Caribou Intake 	No	No	No	<ul style="list-style-type: none"> Increase shading along Poe Reach
	2c	<ul style="list-style-type: none"> Decrease Prattville Intake release to 500 cfs to cause cold water selective withdrawal Extend the existing deeper channel of Butt Valley Reservoir by dredging Use Caribou #1 exclusively with reduced release to cause cold water selective withdrawal from Butt Valley Reservoir Repair/modify Canyon Dam low level outlet and increase release to 600 cfs 				<ul style="list-style-type: none"> Increase Poe Dam release to 360 cfs
3. Reduce the temperature in Belden Forebay to 16.0 °C. (2 variations)	3	<ul style="list-style-type: none"> Install Prattville thermal curtain with levee removed Install a thermal curtain near Caribou Intake in Butt Valley Reservoir Increase Canyon Dam release to 250 cfs (and decrease Prattville Intake release commensurately) 	<ul style="list-style-type: none"> Convey warm water to 100 cfs from East Branch NFFR to Rock Creek Reservoir by diversion/pipeline <p>Note: This measure is designed to protect the lower Belden Reach.</p>	No	<ul style="list-style-type: none"> Increase Cresta Dam release to 390 cfs Increase Grizzly Creek release to 50 cfs 	<ul style="list-style-type: none"> Increase Poe Dam release to 300 cfs Construct outlet/pipeline from the Poe Adit and release to 400 cfs the cooler water to the Poe Reach

Note: All alternatives will have no affect on Lake Almanor water levels except Alternative 2c which, due to significant flow reduction at the Prattville Intake, would result in higher summer lake levels than those that occurred historically.

Table 5-1 Initial Level 2 Alternatives to Achieve the 20°C Objective Target for Water Temperature along the NFFR (continued)

(Note: **bold** denotes refinement to final Level 1 alternative)

Alternative Category	Alternative		Variations for Cooling Downstream Reaches			
	Alt.	Measures in reducing source water temperature to Belden Forebay	Additional measures for Belden Reach	Additional measures for Rock Creek Reach	Additional measures for Cresta Reach	Additional measures for Poe Reach
4. Reduce the temperature in Belden Forebay to 18.0 °C. (120 variations)	4a	<ul style="list-style-type: none"> Install Prattville thermal curtain Install a thermal curtain near Caribou Intake in Butt Valley Reservoir 	<ul style="list-style-type: none"> Convey warm water to 100 cfs from East Branch NFFR to Rock Creek Reservoir by diversion/pipeline <p>Note: This measure is designed to protect the lower Belden Reach.</p>	<ul style="list-style-type: none"> Construct Yellow Cr/ Belden PH bifurcation or, convey Yellow Creek flows to 60 cfs by pipeline to Rock Creek Reservoir for plunging Construct low level outlet at Rock Creek Dam Dredge a submerged channel in Rock Creek Reservoir 	<ul style="list-style-type: none"> Convey cold Bucks Creek PH flows to 140 cfs to Cresta Reservoir for plunging by pipeline Construct low level outlet at Cresta Dam 	<ul style="list-style-type: none"> Increase Poe Dam release to 400 cfs Construct outlet/pipeline from the Poe Adit and release to 450 cfs of cooler water to the Poe Reach
	4b	<ul style="list-style-type: none"> Install Prattville thermal curtain Use Caribou #1 preferentially over Caribou #2 		<ul style="list-style-type: none"> Bypass Yellow Creek flows to 60 cfs around Rock Creek Reservoir by diversion/pipeline 	<ul style="list-style-type: none"> Bypass cold Bucks Creek PH flows to 95 cfs around Cresta Reservoir by diversion/pipeline 	
	4c	<ul style="list-style-type: none"> Repair/modify Canyon Dam low level outlet and increase release to 600 cfs (and decrease Prattville Intake release commensurately) Use Caribou #1 preferentially over Caribou #2 		<ul style="list-style-type: none"> Increase Rock Creek Dam release to 400 cfs 	<ul style="list-style-type: none"> Increase Cresta Dam release to 500 cfs Increase Grizzly Creek releases to 80 cfs 	<ul style="list-style-type: none"> Construct 200 cfs capacity water chiller at Poe Dam
		<ul style="list-style-type: none"> Construct 150 cfs capacity water chiller at Rock Creek Dam 	<ul style="list-style-type: none"> Construct 175 cfs capacity water chiller at Cresta Dam 			
5. Reduce the temperature in Belden Forebay to 19.5 °C. (240 variations)	5a	<ul style="list-style-type: none"> Use Caribou #1 preferentially over Caribou #2 Repair/modify Canyon Dam low level outlet and increase release to 250 cfs or higher (and decrease Prattville Intake release commensurately) 	<ul style="list-style-type: none"> Convey cold Seneca Reach flows to 250 cfs to Belden Reservoir for plunging by diversion/pipeline Install a thermal curtain near Belden PH Intake Convey warm water to 100 cfs in East Branch NFFR to Rock Creek Reservoir by diversion/pipeline 	<ul style="list-style-type: none"> Construct Yellow Cr/ Belden PH bifurcation or, convey Yellow Creek flows to 60 cfs by pipeline to Rock Creek Reservoir for plunging Convey lower Belden Reach flows to 140 cfs to Rock Creek Reservoir for plunging Dredge a submerged channel in Rock Creek Reservoir Construct low level outlet at Rock Creek Dam 	<ul style="list-style-type: none"> Convey cold Bucks Creek PH flows to 140 cfs to Cresta Reservoir for plunging by diversion/pipeline Dredge a submerged channel in Cresta Reservoir Construct low level outlet at Cresta Dam 	<ul style="list-style-type: none"> Increase Poe Dam release Construct outlet/pipeline from the Poe Adit and release the cooler water to the Poe Reach
	5b	<ul style="list-style-type: none"> Install thermal curtain near Caribou Intake in Butt Valley Reservoir Repair/modify Canyon Dam low level outlet and increase release to 250 cfs or higher (and decrease Prattville Intake release commensurately) 	<ul style="list-style-type: none"> Operate Caribou PHs in strict peaking mode with several hours shut down 	<ul style="list-style-type: none"> Bypass Yellow Creek/Chips Creek flows to 80 cfs around Rock Creek Reservoir by diversion/pipeline 	<ul style="list-style-type: none"> Increase Cresta Dam release to 700 cfs 	
	5c	<ul style="list-style-type: none"> Convey Butt Valley PH discharges to 2,000 cfs by pipeline to Butt Valley Res. near the Caribou Intake Repair/modify Canyon Dam low level outlet and increase release to 250 cfs or higher (and decrease Prattville Intake release commensurately) 	<ul style="list-style-type: none"> Convey warm water to 100 cfs from East Branch NFFR to Rock Creek Reservoir by diversion/pipeline 	<ul style="list-style-type: none"> Increase Rock Creek Dam release to 600 cfs 	<ul style="list-style-type: none"> Increase Grizzly Creek releases to 100 cfs 	<ul style="list-style-type: none"> Construct 200 cfs capacity water chiller at Poe Dam
			<ul style="list-style-type: none"> Construct 150 cfs capacity water chiller at Rock Creek Dam 	<ul style="list-style-type: none"> Construct 175 cfs capacity water chiller at Cresta Dam 		

**Table 5-1 Initial Level 2 Alternatives to Achieve the 20°C Objective Target for Water Temperature along the NFFR
(continued)**

(Note: **bold** denotes refinement to final Level 1 alternative)

Alternative Category	Alternative		Variations for Cooling Downstream Reaches			
	Alt.	Measures in reducing source water temperature to Belden Forebay	Additional measures for Belden Reach	Additional measures for Rock Creek Reach	Additional measures for Cresta Reach	Additional measures for Poe Reach
6. Reduce temperatures in all downstream reaches. (2 variations)	6a	No	<ul style="list-style-type: none"> Repair/modify Canyon Dam low level outlet and increase release to 250 cfs Convey cold Seneca Reach flows to Belden Reservoir for plunging by diversion/pipeline Increase Belden Dam/Oak Flat PH release to 250 cfs Convey warm water to 100 cfs in East Branch NFFR to Rock Creek Reservoir by diversion/pipeline 	<ul style="list-style-type: none"> Bypass lower Belden Reach flows to 250 cfs around Rock Creek Reservoir by diversion/pipeline <p>Note: Must be combined with bypassing Seneca flows around Belden Reservoir.</p>	<ul style="list-style-type: none"> Bypass lower Rock Creek Reach flows to 250 cfs around Cresta Reservoir by diversion/pipeline <p>Note: Must be combined with bypassing Seneca flows around Belden Reservoir.</p>	<ul style="list-style-type: none"> Bypass lower Cresta Reach flows to 250 cfs around Poe Reservoir by diversion/ pipeline <p>Note: Must be combined with bypassing Seneca flows around Belden Reservoir.</p>
	6b		<ul style="list-style-type: none"> Increase Canyon Dam low level outlet release to 90 cfs or higher Operate Caribou PHs in strict peaking mode with several hours shut down Convey warm water to 100 cfs in East Branch NFFR to Rock Creek Reservoir by diversion/pipeline 	<ul style="list-style-type: none"> Construct 150 cfs capacity water chiller at Rock Creek Dam 	<ul style="list-style-type: none"> Construct 175 cfs capacity water chiller at Cresta Dam 	<ul style="list-style-type: none"> Construct 200 cfs capacity water chiller at Poe Dam

Notes:

- 1) Water temperature reduction alternative 6a is created by combining the measures in the first row. Accordingly, Alternative 6a has only one alternative and variation.
- 2) Water temperature reduction alternative 6b is created by combining the measures in the second row. Accordingly, Alternative 6b has only one alternative and variation.

Table 5-2a Summary of Cost Estimates for Alternative Category 2

Alt.	Measures	Capital Cost (\$)				Annual Cost (\$/year)				
		Construction	Contingency	Design and Mgmt	Total	Amortized Capital	Annual O&M	Foregone Power Generation Loss		Total
								KWh ×10 ⁶ /year	\$/year	
Measures in Reducing Source Water Temperature to Belden Forebay										
2a	Install Prattville thermal curtain and remove submerged levees	8,068,000	2,824,000	2,723,000	13,615,000	529,000	136,000	0.00	0	665,000
	Construct bypass pipeline to convey Butt Valley PH discharges to 2,000 cfs to Butt Valley Reservoir near Caribou Intakes	101,560,000	35,546,000	34,277,000	171,383,000	6,661,000	428,000	7.29	474,000	7,563,000
	Subtotal	109,628,000	38,370,000	37,000,000	184,998,000	7,190,000	564,000	7.29	474,000	8,228,000
2c	Decrease Prattville Intake Release to 500 cfs to cause cold water selective withdrawal	0	0	0	0	0	0	0.00	0	0
	Extend the Existing Bottom Channel of Butt Valley Reservoir to near Caribou #1 Intake by Dredging	11,876,000	4,157,000	4,008,000	20,041,000	779,000	200,000	0.00	0	979,000
	Operate Caribou #1 PH Exclusively	0	0	0	0	0	0	10.88	707,000	707,000
	Modify Canyon Dam Low-Level Outlet to Increase Canyon Dam Release to 600 cfs	12,000,000	4,200,000	4,050,000	20,250,000	787,000	101,000	79.17	5,146,000	6,034,000
	Subtotal	23,876,000	8,357,000	8,058,000	40,291,000	1,566,000	301,000	90.05	5,853,000	7,720,000
Additional Measures for Poe Reach										
(1)	Increase shading along Poe Reach *									
(2)	Increase Poe Dam release to 360 cfs	0	0	0	0	0	0	7.72	502,000	502,000
(3)	Construct outlet/pipeline from Poe Adit to release cool water to 180 cfs	2,998,000	1,049,000	1,012,000	5,059,000	197,000	13,000	8.69	565,000	775,000

Note: A water temperature reduction alternative is created by combining any numbered “measure” in reducing source water temperature to Belden Forebay together with one “additional measure” provided for each downstream reach.

* Cost was not estimated.

Table 5-2b Summary of Cost Estimates for Alternative Category 3

Alt.	Measures	Capital Cost (\$)				Annual Cost (\$/year)				
		Construction	Contingency	Design and Mgmt	Total	Amortized Capital	Annual O&M	Foregone Power Generation Loss		Total
								KWh ×10 ⁶ /year	\$/year	
Measures in Reducing Source Water Temperature to Belden Forebay										
3	Install Prattville thermal curtain and remove submerged levees	8,068,000	2,824,000	2,723,000	13,615,000	529,000	136,000	0.00	0	665,000
	Install Caribou Intake thermal curtain	5,377,000	1,882,000	1,815,000	9,074,000	353,000	91,000	0.00	0	444,000
	Modify Canyon Dam low-level outlet to increase Canyon Dam release to 250 cfs	6,000,000	2,100,000	2,025,000	10,125,000	394,000	51,000	26.39	1,715,000	2,160,000
	Subtotal	19,445,000	6,806,000	6,563,000	32,814,000	1,276,000	278,000	26.39	1,715,000	3,269,000
Additional Measures for Belden Reach										
(1)	Construct bypass pipeline to convey warm water to 100 cfs from EBNFFR into upper Rock Creek Reservoir	4,048,000	1,417,000	1,366,000	6,831,000	265,000	17,000	0.00	0	282,000
Additional Measures for Cresta Reach										
(1)	Increase Cresta Dam release to 390 cfs	0	0	0	0	0	0	6.29	409,000	409,000
(2)	Increase Grizzly Creek release to 50 cfs	0	0	0	0	0	0	9.81	638,000	638,000
Additional Measures for Poe Reach										
(1)	Increase Poe Dam release to 300 cfs	0	0	0	0	0	0	4.83	314,000	314,000
	Construct outlet/pipeline from Poe Adit to release cool water to 400 cfs	2,998,000	1,049,000	1,012,000	5,059,000	197,000	13,000	19.31	1,255,000	1,465,000
	Subtotal	2,998,000	1,049,000	1,012,000	5,059,000	197,000	13,000	24.14	1,569,000	1,779,000

Note: A water temperature reduction alternative is created by combining any numbered “measure” in reducing source water temperature to Belden Forebay together with one “additional measure” provided for each downstream reach.

Table 5-2c Summary of Cost Estimates for Alternative Category 4

Alt.	Measures	Capital Cost (\$)				Annual Cost (\$/year)				
		Construction	Contingency	Design and Mgmt	Total	Amortized Capital	Annual O&M	Foregone Power Generation Loss		Total
								KWh ×10 ⁶ /year	\$/year	
Measures in Reducing Source Water Temperature to Belden Forebay										
4a	Install Prattville thermal curtain	5,948,000	2,082,000	2,008,000	10,038,000	390,000	100,000	0.00	0	490,000
	Install Caribou Intake thermal curtain	5,377,000	1,882,000	1,815,000	9,074,000	353,000	91,000	0.00	0	444,000
	Subtotal	11,325,000	3,964,000	3,823,000	19,112,000	743,000	191,000	0.00	0	934,000
4b	Install Prattville thermal curtain	5,948,000	2,082,000	2,008,000	10,038,000	390,000	100,000	0.00	0	490,000
	Operate Caribou #1 PH preferentially	0	0	0	0	0	0	13.91	904,000	904,000
	Subtotal	5,948,000	2,082,000	2,008,000	10,038,000	390,000	100,000	13.91	904,000	1,394,000
4c	Modify Canyon Dam low-level outlet to increase Canyon Dam release to 600 cfs	12,000,000	4,200,000	4,050,000	20,250,000	787,000	101,000	79.17	5,146,000	6,034,000
	Operate Caribou #1 PH preferentially	0	0	0	0	0	0	11.32	736,000	736,000
	Subtotal	12,000,000	4,200,000	4,050,000	20,250,000	787,000	101,000	90.49	5,882,000	6,770,000
Additional Measures for Belden Reach										
(1)	Construct bypass pipeline to convey warm water to 100 cfs from EBNFFR into upper Rock Creek Reservoir	4,048,000	1,417,000	1,366,000	6,831,000	265,000	17,000	0.00	0	282,000
Additional Measures for Rock Creek Reach										
(1)	Convey Yellow Creek flows to 60 cfs to Rock Creek Reservoir for plunging									
	Dredge a submerged channel in Rock Creek Reservoir									
	Construct low-level outlet at Rock Creek Dam									
	Subtotal *	13,516,000	4,731,000	4,562,000	22,809,000	886,000	57,000	0.00	0	943,000
(2)	Construct bypass pipeline to convey Yellow Creek flows to 60 cfs around Rock Creek Reservoir	12,576,000	4,402,000	4,245,000	21,223,000	825,000	53,000	0.00	0	878,000
(3)	Increase Rock Creek Dam release to 400 cfs	0	0	0	0	0	0	14.46	940,000	940,000
(4)	Construct 150 cfs capacity water chiller near Rock Creek Dam	3,401,000	1,190,000	1,148,000	5,739,000	223,000	172,000	5.05	328,000	723,000

* Cost was estimated for combined measure.

Table 5-2c Summary of Cost Estimates for Alternative Category 4 (Continued)

		Capital Cost (\$)				Annual Cost (\$/year)				
		Construction	Contingency	Design and Mgmt	Total	Amortized Capital	Annual O&M	Foregone Power Generation Loss		Total
								KWh ×10 ⁶ /year	\$/year	
Additional Measures for Cresta Reach										
(1)	Construct bypass pipeline to convey Bucks Creek PH flows to 140 cfs to Cresta Reservoir for plunging									
	Construct low-level outlet at Cresta Dam									
	Subtotal *	14,597,000	5,109,000	4,927,000	24,633,000	957,000	62,000	0.00	0	1,019,000
(2)	Construct bypass pipeline to convey Bucks Creek PH flows to 95 cfs around Cresta Reservoir	17,770,000	6,220,000	5,998,000	29,988,000	1,165,000	75,000	0.00	0	1,240,000
(3)	Increase Cresta Dam release to 500 cfs	0	0	0	0	0	0	9.50	618,000	618,000
(4)	Increase Grizzly Creek release to 80 cfs	0	0	0	0	0	0	16.50	1,073,000	1,073,000
(5)	Construct 175 cfs capacity water chiller near Cresta Dam	6,039,000	2,114,000	2,038,000	10,191,000	396,000	306,000	9.09	591,000	1,293,000
Additional Measures for Poe Reach										
(1)	Increase Poe Dam release to 400 cfs	0	0	0	0	0	0	9.66	628,000	628,000
	Construct outlet/pipeline from Poe Adit to release cool water to 450 cfs	2,998,000	1,049,000	1,012,000	5,059,000	197,000	13,000	21.72	1,412,000	1,622,000
	Subtotal	2,998,000	1,049,000	1,012,000	5,059,000	197,000	13,000	31.38	2,040,000	2,250,000
(2)	Construct 200 cfs capacity water chiller near Poe Dam	8,285,000	2,900,000	2,796,000	13,981,000	543,000	419,000	13.12	853,000	1,815,000

Note: A water temperature reduction alternative is created by combining any numbered “measure” in reducing source water temperature to Belden Forebay together with one “additional measure” provided for each downstream reach.

* Cost was estimated for combined measure.

Table 5-2d Summary of Cost Estimates for Alternative Category 5

Alt.	Measures	Capital Cost (\$)				Annual Cost (\$/year)				
		Construction	Contingency	Design and Mgmt	Total	Amortized Capital	Annual O&M	Foregone Power Generation Loss		Total
								KWh ×10 ⁶ /Year	\$/year	
Measures in Reducing Source Water Temperature to Belden Forebay										
5a	Modify Canyon Dam low-level outlet to increase Canyon Dam release to 250 cfs or higher	6,000,000	2,100,000	2,025,000	10,125,000	394,000	51,000	26.39	1,715,000	2,160,000
	Operate Caribou #1 PH preferentially	0	0	0	0	0	0	14.31	930,000	930,000
	Subtotal	6,000,000	2,100,000	2,025,000	10,125,000	394,000	51,000	40.70	2,645,000	3,090,000
5b	Install Caribou Intake thermal curtain	5,377,000	1,882,000	1,815,000	9,074,000	353,000	91,000	0.00	0	444,000
	Modify Canyon Dam low-level outlet to increase Canyon Dam release to 250 cfs or higher	6,000,000	2,100,000	2,025,000	10,125,000	394,000	51,000	26.39	1,715,000	2,160,000
	Subtotal	11,377,000	3,982,000	3,840,000	19,199,000	747,000	142,000	26.39	1,715,000	2,604,000
5c	Modify Canyon Dam low-level outlet to increase Canyon Dam release to 250 cfs or higher	6,000,000	2,100,000	2,025,000	10,125,000	394,000	51,000	26.39	1,715,000	2,160,000
	Construct bypass pipeline to convey Butt Valley PH discharges to 2,000 cfs to Butt Valley Reservoir near Caribou Intakes	101,560,000	35,546,000	34,277,000	171,383,000	6,661,000	428,000	7.29	474,000	7,563,000
	Subtotal	107,560,000	37,646,000	36,302,000	181,508,000	7,055,000	479,000	33.68	2,189,000	9,723,000
Additional Measures for Belden Reach										
(1)	Construct bypass pipeline to convey Seneca Reach flows to 250 cfs to Belden Reservoir for plunging	9,486,000	3,320,000	3,202,000	16,008,000	622,000	40,000	0.00	0	662,000
	Install Belden PH Intake thermal curtain	3,371,000	1,180,000	1,138,000	5,689,000	221,000	57,000	0.00	0	278,000
	Construct bypass pipeline to convey warm water to 100 cfs from EBNFFR into upper Rock Creek Reservoir	4,048,000	1,417,000	1,366,000	6,831,000	265,000	17,000	0.00	0	282,000
	Subtotal	16,905,000	5,917,000	5,706,000	28,528,000	1,108,000	114,000	0.00	0	1,222,000
(2)	Operate Caribou PHs in strict peaking mode with several hours shutdown	0	0	0	0	0	0	0.00	0	0
	Construct bypass pipeline to convey warm water to 100 cfs from EBNFFR into upper Rock Creek Reservoir	4,048,000	1,417,000	1,366,000	6,831,000	265,000	17,000	0.00	0	282,000
	Subtotal	4,048,000	1,417,000	1,366,000	6,831,000	265,000	17,000	0.00	0	282,000

Table 5-2d Summary of Cost Estimates for Alternative Category 5 (Continued)

		Capital Cost (\$)				Annual Cost (\$/year)				
		Construction	Contingency	Design and Mgmt	Total	Amortized Capital	Annual O&M	Foregone Power Generation Loss		Total
								KWh ×10 ⁶ /Year	\$/year	
Additional Measures for Rock Creek Reach										
(1)	Convey Yellow Creek flows to 60 cfs to Rock Creek Reservoir for plunging									
	Convey lower Belden Reach flows to 140 cfs to Rock Creek Reservoir for plunging									
	Dredge a submerged channel in Rock Creek Reservoir									
	Construct low-level outlet at Rock Creek Dam									
	Subtotal *	18,309,000	6,408,000	6,179,000	30,896,000	1,201,000	77,000	0.00	0	1,278,000
(2)	Construct bypass pipeline to convey Yellow Creek/ Chips Creek flows to 80 cfs around Rock Creek Reservoir	15,652,000	5,478,000	5,283,000	26,413,000	1,027,000	66,000	0.00	0	1,093,000
(3)	Increase Rock Creek Dam release to 600 cfs	0	0	0	0	0	0	26.03	1,692,000	1,692,000
(4)	Construct 150 cfs capacity water chiller near Rock Creek Dam	4,171,000	1,460,000	1,408,000	7,039,000	274,000	211,000	7.07	460,000	945,000
Additional Measures for Cresta Reach										
(1)	Construct bypass pipeline to convey Bucks Creek PH flows to 140 cfs to Cresta Reservoir for plunging									
	Dredge a submerged channel in Cresta Reservoir									
	Construct low-level outlet at Cresta Dam									
	Subtotal *	21,913,000	7,670,000	7,396,000	36,979,000	1,437,000	92,000	0.00	0	1,529,000
(2)	Construct bypass pipeline to convey Bucks Creek PH flows to 110 cfs around Cresta Reservoir	17,770,000	6,220,000	5,998,000	29,988,000	1,165,000	75,000	0.00	0	1,240,000
(3)	Increase Cresta Dam release to 700 cfs	0	0	0	0	0	0	15.35	998,000	998,000
(4)	Increase Grizzly Creek release to 100 cfs	0	0	0	0	0	0	20.96	1,362,000	1,362,000
(5)	Construct 175 cfs capacity water chiller near Cresta Dam	6,809,000	2,383,000	2,298,000	11,490,000	447,000	345,000	11.10	722,000	1,514,000
Additional Measures for Poe Reach										
(1)	Increase Poe Dam release									
	Construct outlet/pipeline from Poe Adit to release cool water									
	Subtotal **									
(2)	Construct 200 cfs capacity water chiller near Poe Dam	9,055,000	3,169,000	3,056,000	15,280,000	594,000	458,000	15.14	984,000	2,036,000

Note: A water temperature reduction alternative is created by combining any numbered “measure” in reducing source water temperature to Belden Forebay together with one “additional measure” provided for each downstream reach. * Cost was estimated for combined measure. ** Cost was not estimated. Further analysis to determine design/operational parameters is required.

Table 5-2e Summary of Cost Estimates for Alternative Category 6

Alt.	Measures	Capital Cost (\$)				Annual Cost (\$/year)				
		Construction	Contingency	Design and Mgmt	Total	Amortized Capital	Annual O&M	Foregone Power Generation Loss		Total
								KWh ×10 ⁶ /year	\$/year	
Measures in Reducing Source Water Temperature to Belden Forebay										
6a	None									
6b	None									
Additional Measures for Belden Reach										
(1)	Modify Canyon Dam Low-Level Outlet to Increase Canyon Dam Release to 250 cfs	6,000,000	2,100,000	2,025,000	10,125,000	394,000	51,000	26.39	1,715,000	2,160,000
	Construct Bypass Pipeline to Convey Seneca Reach Flows (250 cfs) to Belden Reservoir for Plunging and increase Belden Dam release to 250 cfs	9,486,000	3,320,000	3,202,000	16,008,000	622,000	40,000	9.26	602,000	1,264,000
	Construct bypass pipeline to convey warm water to 100 cfs from EBNFFR into upper Rock Creek Reservoir	4,048,000	1,417,000	1,366,000	6,831,000	265,000	17,000	0.00	0	282,000
	Subtotal	19,534,000	6,837,000	6,593,000	32,964,000	1,281,000	108,000	35.65	2,317,000	3,706,000
(2)	Increase Canyon Dam Low-Level Outlet Release to the Required Minimum Flow 90 cfs	0	0	0	0	0	0	0.00	0	0
	Operate Caribou PHs in Strict Peaking Mode with Several Hours Shutdown	0	0	0	0	0	0	0.00	0	0
	Construct bypass pipeline to convey warm water to 100 cfs from EBNFFR into upper Rock Creek Reservoir	4,048,000	1,417,000	1,366,000	6,831,000	265,000	17,000	0.00	0	282,000
	Subtotal	4,048,000	1,417,000	1,366,000	6,831,000	265,000	17,000	0.00	0	282,000
Additional Measures for Rock Creek Reach										
(1)	Construct Bypass Pipeline to Convey Lower Belden Reach Flows to 250 cfs around Rock Creek Reservoir	15,242,000	5,335,000	5,144,000	25,721,000	1,000,000	64,000	5.78	376,000	1,440,000
(2)	Construct 150 cfs capacity water chiller near Rock Creek Dam	6,096,000	2,134,000	2,058,000	10,288,000	400,000	309,000	12.11	787,000	1,496,000

Table 5-2e Summary of Cost Estimates for Alternative Category 6 (Continued)

		Capital Cost (\$)				Annual Cost (\$/year)				
		Construction	Contingency	Design and Mgmt	Total	Amortized Capital	Annual O&M	Foregone Power Generation Loss		Total
								KWh ×10 ⁶ /year	\$/year	
Additional Measures for Cresta Reach										
(1)	Construct Bypass Pipeline to Convey Lower Rock Creek Reach Flows to 250 cfs around Cresta Reservoir	16,299,000	5,705,000	5,501,000	27,505,000	1,069,000	69,000	2.19	142,000	1,280,000
(2)	Construct 175 cfs capacity water chiller near Cresta Dam	8,349,000	2,922,000	2,818,000	14,089,000	548,000	423,000	15.14	984,000	1,955,000
Additional Measures for Poe Reach										
(1)	Construct Bypass Pipeline to Convey Lower Cresta Reach Flows to 250 cfs around Poe Reservoir	13,066,000	4,573,000	4,410,000	22,049,000	857,000	55,000	2.41	157,000	1,069,000
(2)	Construct 200 cfs capacity water chiller near Poe Dam	11,750,000	4,113,000	3,966,000	19,829,000	771,000	595,000	22.21	1,444,000	2,810,000

Notes:

- 1) Water temperature reduction alternative 6a is created by combining the first numbered “measure” in reducing source water temperature to Belden Forebay together with the first numbered “additional measure” provided for each downstream reach.
- 2) Water temperature reduction alternative 6b is created by combining the second numbered “measure” in reducing source water temperature to Belden Forebay together with the second numbered “additional measure” provided for each downstream reach.

5.2 SCREENING OF INITIAL LEVEL 2 WATER TEMPERATURE REDUCTION ALTERNATIVES AND FINAL LEVEL 2 WATER TEMPERATURE REDUCTION ALTERNATIVES

Due to the large number of alternative variations at the completion of the Level 1 effort plus the addition of flow-related measures as choices for the Rock Creek, Cresta, and Poe reaches, the State Water Board identified the need to enhance the screening process for the initial Level 2 water temperature reduction alternatives. The following coarse screening criteria were applied to these water temperature reduction alternatives:

- Effectiveness and reliability – Is there a reasonable potential that the alternative can effectively and reliably achieve the preliminary temperature target or, is the effectiveness and reliability of the alternative overly speculative?
- Technological feasibility and constructability – Can the alternative be implemented with currently available technology and construction methods?
- Logistics – Can the alternative be implemented when considering current legal obligations, regulatory permitting requirements, public safety needs, right-of-way and access needs, and other real world logistical constraints?
- Reasonability²⁸ – Are there clearly more reasonable or superior alternatives available based on the other criteria? Is implementation of the alternative remote or highly speculative?

plus,

- Substantial Further Study -- Is there sufficient information available or can it be readily developed in order to evaluate the potential effectiveness and feasibility of the alternative, or is substantial further investigation or study required?
- Environmental challenges – Are there obvious environmental consequences or problems associated with the alternative that would pose a major challenge to overcome?
- Economic feasibility – Can the alternative be implemented at a reasonable cost, including capital, O&M, and considering energy replacement costs?

Through the Level 2 screening, the application of these criteria reduced the number of variations available and resulted in the elimination of certain alternatives or measures. The process of eliminating alternatives/measures incorporated a grading system where values were assigned under each of the screening criterion to identify how well a particular alternative/measure met the criteria. Four grades were used in Level 2 screening: Fail, 1 (nearly fails), 2 (minor concerns), or 3 (meets the criterion). One “fail” or consistent low grades across the criteria were grounds for elimination of the alternative/measure. Operational modification measures were not graded for the technological feasibility/ constructability criterion. Tables 5-3a through 5-3e summarize justifications for the elimination of certain initial Level 2 water temperature reduction alternatives and other individual additional water temperature reduction measures considered for downstream reaches. The following discussion provides the rationale for the elimination of certain alternatives/measures.

²⁸ An EIR need not consider an alternative whose effect cannot be reasonably ascertained and whose implementation is remote and speculative (CEQA Guidelines, § 15126, subd. (d)).

Elimination of Alternatives/Measures

Alternative 2a fails the technological feasibility/constructability, reasonability, and economic feasibility criteria. This alternative consists of the measure of conveying Butt Valley PH discharge (2,000 cfs) through Butt Valley Reservoir by submerged pipeline to an endpoint near the Caribou Intakes, which requires placing seven, 72-inch diameter pipelines, 5-miles long along the bottom of Butt Valley Reservoir and requires designing and installing an anchoring system adequate to withstand the potential forces on the pipe arising from flow momentum and land shifting. The measure also requires connecting three 13' x 9.5' conduits to the Butt Valley PH turbine discharge pipes which are inside of the powerhouse structure. The constructability of this alternative is highly uncertain. Construction would be difficult and the capital cost is estimated to be very high (over \$100 million). In addition, there is another alternative in Alternative Category 2, Alternative 2c, that has considerably less uncertainty and is more reasonable than Alternative 2a. Consequently, Alternative 2a was eliminated.

Alternative 5c, like Alternative 2a, also includes construction of a submerged pipeline along the bottom of Butt Valley Reservoir. Following the same reasoning for Alternative 2a, Alternative 5c fails the technological feasibility/constructability, reasonability, and the economic feasibility criteria. Consequently, Alternative 5c was eliminated.

Alternative 6a fails the technological feasibility/constructability criterion. This alternative requires the construction of bypass pipelines around Rock Creek Reservoir, Cresta Reservoir, and Poe Reservoir. Bypassing Rock Creek Reservoir requires: 1) attaching a bridge crossing structure and steel pipeline to the existing Highway 70 bridge over Chips Creek; 2) burying a 66-inch Reinforced Concrete Pipe near the channel along the north bank of the NFFR just upstream of the confluence with Yellow Creek; and 3) connecting 155 LF of 66-inch Black Steel Pipe to the steep rock face at the dam. Bypassing Cresta Reservoir requires: 1) attaching a 66-inch HDPE pipe to the existing 7'-8 3/8" I.D. sluice pipe underwater at the toe of Cresta Dam; 2) connecting a 66-inch black steel pipe to the concrete face of Rock Creek PH without affecting the existing discharge of the PH; 3) placing a 66-inch, 2-mile long HDPE along the bottom of Cresta Reservoir. Bypassing Poe Reservoir requires: 1) connecting a 66-inch black steel pipe to the concrete face of Cresta PH without affecting the existing discharge of the PH; 2) placing a 66-inch, one-mile long HDPE along the bottom of Poe Reservoir; and 3) attaching a 66-inch HDPE pipe to the existing 66-inch outlet pipe underwater at the toe of the dam. The constructability of this alternative is highly uncertain, and construction would be difficult and the capital cost is estimated to be very high (over \$100 million). Consequently, Alternative 6a was eliminated.

Alternative 6b fails the logistics criterion. This alternative requires installing multiple large capacity water chillers near each of Rock Creek, Cresta, and Poe Dams. The chillers should be located above the 100-year floodplain to avoid significant safety hazards: Siting the chillers in suitable locations outside of the flood hazard area would require further investigation. The chillers would be large and unsightly, which could aesthetically degrade the scenic river corridor. The chillers could produce fog creating a safety hazard. Consequently, Alternative 6b was eliminated.

Table 5-3a Screening of Alternative/ Measures under Alternative Category 2

(Level 2 screening eliminations identified in red; Four grades used in Level 2 screening: Fail, 1 (nearly fails), 2 (minor concerns), or 3 (meets the criterion); One failure or consistent low grades are grounds for elimination; Operational modification measures not graded for the technological feasibility/ constructability criterion)

Alt.	Measures	Economics			Screening Criteria						Evaluation Result
		Amortized Capital and Annual O&M (\$/year)	Energy Replacement Cost (\$/year)	Total Annual Cost (\$/year)	Effectiveness and Reliability	Technological Feasibility/ Constructability	Logistics	Reasonability	Substantial Further Study	Environ. Challenges	
Measures in Reducing Source Water Temperature to Belden Forebay											
2a	Install Prattville thermal curtain and remove submerged levees	665,000	0	665,000							
	Construct bypass pipeline to convey Butt Valley PH discharges to 2,000 cfs to Butt Valley Reservoir near Caribou Intakes	7,089,000	474,000	7,563,000		Fail		Fail			Eliminate ^a
	Subtotal	7,754,000	474,000	8,228,000							
2b	Install Prattville Intake thermal curtain and remove submerged levees										
	Install Caribou Intake thermal Curtain										
	Collect and convey cold spring water (215 cfs, 8°C) to Prattville Intake										
2c	Decrease Prattville Intake Release to 500 cfs to cause cold water selective withdrawal	0	0 *	0	3		3	3	3	3	
	Extend the Existing Bottom Channel of Butt Valley Reservoir to near Caribou #1 Intake by Dredging	979,000	0	979,000	2	2	2 (reg. permitting)	2	2	1 (dredging effects)	
	Operate Caribou #1 PH Exclusively	0	707,000	707,000	3		3	3	3	3	
	Modify Canyon Dam Low-Level Outlet to Increase Canyon Dam Release to 600 cfs	888,000	5,146,000 **	6,034,000	3	3	3	3	3	3	
	Subtotal	1,867,000	5,853,000	7,720,000							
Additional Measures for Poe Reach											
(1)	Increase shading along Poe Reach					Fail					Eliminate ^b
(2)	Increase Poe Dam release to 360 cfs	0	502,000	502,000	3		3	3	3	3	
(3)	Construct outlet/pipeline from Poe Adit to release cool water to 180 cfs	210,000	565,000	775,000				Fail			Eliminate ^c

* No foregone power generation loss was assumed for the measure of reduced Prattville Intake release since the water would still be stored in Lake Almanor for power generation at a later time. It is acknowledged that power prices are higher during the peak demand summer season than other non-peak demand seasons and, as such, PG&E would incur added cost to purchase the summer replacement power based on the seasonal price differential.

** Foregone power generation loss due to increased Canyon Dam releases could be partially offset by discharging the releases through a new hydropower plant constructed at the dam.

a) See the justification for elimination of Alternative 2a in Section 5.2.

b) The measure of increased shading along Poe Reach fails the technological feasibility/constructability criterion. Existing shading along the Poe Reach is low (about 20%) because the channel bed is mainly rock and not suitable for growing trees.

c) This measure fails the reasonability criterion since there is another measure, the increased Poe Dam release measure, that is clearly superior and more reasonable.

Table 5-3b Screening of Alternative/ Measures under Alternative Category 3

(Level 2 screening eliminations identified in red. Four grades used in Level 2 screening: Fail, 1 (nearly fails), 2 (minor concerns), or 3 (meets the criterion); One failure or consistent low grades are grounds for elimination; Operational modification measures not graded for the technological feasibility/ constructability criterion)

Alt.	Measures	Economics			Screening Criteria						Evaluation Result
		Amortized Capital and Annual O&M (\$/year)	Energy Replacement Cost (\$/year)	Total Annual Cost (\$/year)	Effectiveness and Reliability	Technological Feasibility/ Constructability	Logistics	Reasonability	Substantial Further Study	Environ. Challenges	
Measures in Reducing Source Water Temperature to Belden Forebay											
3	Install Prattville thermal curtain and remove submerged levees	665,000	0	665,000	3	3	2	3	1 (cultural resources)	2 (levee removal)	
	Install Caribou Intake thermal curtain	444,000	0	444,000	3	3	3	3	2 (curtain location)	3	
	Modify Canyon Dam low-level outlet to increase Canyon Dam release to 250 cfs	445,000	1,715,000	2,160,000	3	3	3	3	3	3	
	Subtotal	1,554,000	1,715,000	3,269,000							
Additional Measures for Belden Reach											
(1)	Construct bypass pipeline to convey warm water to 100 cfs from EBNFFR into upper Rock Creek Reservoir	282,000	0	282,000	3	2 (construction along river)	2 (reg. permitting)	3	2 (pipeline alignment)	2 (construction effects)	
Additional Measures for Cresta Reach											
(1)	Increase Cresta Dam release to 390 cfs	0	409,000	409,000	3		3	3	3	3	
(2)	Increase Grizzly Creek release to 50 cfs	0	638,000	638,000				Fail			Eliminated ^a
Additional Measures for Poe Reach											
(1)	Increase Poe Dam release to 300 cfs	0	314,000	314,000	3		3	3	3	3	
	Construct outlet/pipeline from Poe Adit to release cool water to 400 cfs	210,000	1,255,000	1,465,000	3	2	3	3	2 (Poe Adit capacity)	3	
	Subtotal	210,000	1,569,000	1,779,000							

a) This measure fails the reasonability criterion since there is another measure, the increased Cresta Dam release measure, that is more reasonable than this measure. Also, this measure may fail the logistics criterion because increasing Grizzly Creek release affects operations of Bucks Creek PH which is owned by the City of Santa Clara.

Table 5-3c Screening of Alternative/ Measures under Alternative Category 4

(Level 2 screening eliminations identified in red. Four grades used in Level 2 screening: Fail, 1 (nearly fails), 2 (minor concerns), or 3 (meets the criterion); One failure or consistent low grades are grounds for elimination; Operational modification measures not graded for the technological feasibility/ constructability criterion)

Alt.	Measures	Economics			Screening Criteria						Evaluation Result
		Amortized Capital and Annual O&M (\$/year)	Energy Replacement Cost (\$/year)	Total Annual Cost (\$/year)	Effectiveness and Reliability	Technological Feasibility/ Constructability	Logistics	Reasonability	Substantial Further Study	Environ. Challenges	
Measures in Reducing Source Water Temperature to Belden Forebay											
4a	Install Prattville thermal curtain	490,000	0	490,000	3	3	3	3	3	3	
	Install Caribou Intake thermal curtain	444,000	0	444,000	3	3	3	3	2 (curtain location)	3	
	Subtotal	934,000	0	934,000							
4b	Install Prattville thermal curtain	490,000	0	490,000	3	3	3	3	3	3	
	Operate Caribou #1 PH preferentially	0	904,000	904,000	3		3	3	3	3	
	Subtotal	490,000	904,000	1,394,000							
4c	Modify Canyon Dam low-level outlet to increase Canyon Dam release to 600 cfs	888,000	5,146,000	6,034,000	3	3	3	3	3	3	
	Operate Caribou #1 PH preferentially	0	736,000	736,000	3		3	3	3	3	
	Subtotal	888,000	5,882,000	6,770,000							
Additional Measures for Belden Reach											
(1)	Construct bypass pipeline to convey warm water to 100 cfs from EBNFFR into upper Rock Creek Reservoir	282,000	0	282,000	3	2 (construction along river)	2 (reg. permitting)	3	2 (pipeline alignment)	2 (construction effects)	
Additional Measures for Rock Creek Reach											
(1)	Construct Yellow Cr/ Belden PH bifurcation or, Convey Yellow Creek flows to 60 cfs by pipeline to Rock Creek Reservoir for plunging										
	Dredge a submerged channel in Rock Creek Reservoir				Fail	Fail			Fail		Eliminated ^a
	Construct low-level outlet at Rock Creek Dam										
	Subtotal	943,000	0	943,000							
(2)	Construct bypass pipeline to convey Yellow Creek flows to 60 cfs around Rock Creek Reservoir	878,000	0	878,000		Fail		Fail		Fail	
(3)	Increase Rock Creek Dam release to 400 cfs	0	940,000	940,000	3		3	3	3	3	
(4)	Construct 150 cfs capacity water chiller near Rock Creek Dam	395,000	328,000	723,000				Fail			Eliminated ^c

Table 5-3c Screening of Alternative/ Measures under Alternative Category 4 (Continued)

		Economics			Screening Criteria						Evaluation Result
		Amortized Capital and Annual O&M (\$/year)	Energy Replacement Cost (\$/year)	Total Annual Cost (\$/year)	Effectiveness and Reliability	Technological Feasibility/ Constructability	Logistics	Reasonability	Substantial Further Study	Environ. Challenges	
Additional Measures for Cresta Reach											
(1)	Construct bypass pipeline to convey Bucks Creek PH flows to 140 cfs to Cresta Reservoir for plunging				Fail	Fail			Fail		Eliminated ^d
	Construct low-level outlet at Cresta Dam										
	Subtotal	1,019,000	0	1,019,000							
(2)	Construct bypass pipeline to convey Bucks Creek PH flows to 95 cfs around Cresta Reservoir	1,240,000	0	1,240,000		Fail		Fail	Fail		Eliminated ^e
(3)	Increase Cresta Dam release to 500 cfs	0	618,000	618,000	3		3	3	3	3	
(4)	Increase Grizzly Creek release to 80 cfs	0	1,073,000	1,073,000	3		3	3	2 (fish study)	2 (effects on fish)	
(5)	Construct 175 cfs capacity water chiller near Cresta Dam	702,000	591,000	1,293,000				Fail			Eliminated ^f
Additional Measures for Poe Reach											
(1)	Increase Poe Dam release to 400 cfs	0	628,000	628,000	2		3	3	3	3	
	Construct outlet/pipeline from Poe Adit to release cool water to 450 cfs	210,000	1,412,000	1,622,000	2	2	3	3	2 (Poe Adit capacity)	3	
	Subtotal	210,000	2,040,000	2,250,000							
(2)	Construct 200 cfs capacity water chiller near Poe Dam	962,000	853,000	1,815,000	3	2	2 (reg. permitting)	1	1 (chiller siting)	1 (air, aesthetic, floodplain)	Eliminated ^g

- a) This measure fails the effectiveness and reliability criterion. The measure was designed mainly based on the 2006 special test result in Butt Valley Reservoir demonstrating that the plunged cold water mainly moved in the submerged channel along the bottom in the upper portion of the reservoir with minimal mixing with warm surface water. Further study is required to evaluate the effectiveness and reliability of applying this measure to Rock Creek Reservoir because Rock Creek Reservoir is relatively shallow, has higher flow velocities and, hence, greater mixing potential than Butt Valley Reservoir. This measure also fails the technological feasibility/constructability criterion because it requires setting a 54-inch HDPE along the bottom of upper Rock Creek Reservoir which could be difficult and costly. Design and installation of an anchoring system adequate to withstand the potential forces on the pipe arising from flow momentum and land shifting requires substantial further study. This measure also requires dredging a submerged channel along the bottom of lower Rock Creek Reservoir which could be difficult and costly since it may require removing large boulders. In addition, the dredged conveyance channel at the bottom of Rock Creek Reservoir will likely fill with sediment and require repeated dredging. Directing Yellow Creek flows around Rock Creek Reservoir poses substantial environmental challenges due to potential effects on fish and regulatory permitting hurdles. The measure of conveying Yellow Creek flows by pipeline to Rock Creek Reservoir for plunging is easier and more reliable than the measure of constructing a Yellow Creek/ Belden PH bifurcation.
- b) This measure fails the technological feasibility/constructability criterion. This measure requires attaching a bridge crossing structure and steel pipeline to the existing Highway 70 bridge over Chips Creek, which could make the existing structure unstable. This measure also requires connecting 155 LF of 42-inch Black Steel Pipe to the steep rock face at the dam, which could be difficult and costly. This measure also fails the reasonability criterion because the increased Rock Creek Dam release measure is clearly superior to this measure. Directing Yellow Creek flows poses substantial environmental challenges due to potential effects on fish and regulatory permitting hurdles.
- c) Constructing a water chiller near Rock Creek Dam fails the reasonability criterion because there is another measure, the increased Rock Cree Dam release measure, that is clearly superior.
- d) Similar to the justifications in a) above, this measure fails the effectiveness and reliability criterion and requires further study because Cresta Reservoir is relatively shallow. This measure also fails the technological feasibility/constructability criterion. This measure requires setting a 54-inch HDPE along the bottom of upper Cresta Reservoir, which could be difficult and costly. Design and installation of an anchoring system adequate to withstand the potential forces on the pipe arising from flow momentum and land shifting requires substantial further study.

- e) This measure fails the technological feasibility/constructability criterion. This measure requires setting a 48-inch HDPE along the bottom of Cresta Reservoir, which could be difficult and costly. Design and installation of an anchoring system adequate to withstand the potential forces on the pipe arising from flow momentum and land shifting requires substantial further study. This measure also requires tying into the existing submerged 92-inch sluice pipe underwater at the toe of Cresta Dam, which could be difficult and costly due to underwater construction. This measure also fails the reasonability criterion because either the increased Cresta Dam release measure or the increased Grizzly Creek release measure is clearly superior to this measure.
- f) Constructing a water chiller near Cresta Dam fails the reasonability criterion because either the increased Cresta Dam release measure or the increased Grizzly Creek release measure is clearly superior to constructing a water chiller near Cresta Dam.
- g) Constructing a water chiller near Poe Dam is relatively unreasonable compared with the increased Poe Dam/ Poe Adit release measure. Siting the chiller above the 100-year floodplain near Poe Dam requires substantial further study. The chiller may have significant negative impacts on air quality, aesthetic quality, and floodplain.

Table 5-3d Screening of Alternative/ Measures under Alternative Category 5

(Level 2 screening eliminations identified in red. Four grades used in Level 2 screening: Fail, 1 (nearly fails), 2 (minor concerns), or 3 (meets the criterion); One failure or consistent low grades are grounds for elimination; Operational modification measures not graded for the technological feasibility/ constructability criterion)

Alt.	Measures	Economics			Screening Criteria						Evaluation Result
		Amortized Capital and Annual O&M (\$/year)	Energy Replacement Cost (\$/year)	Total Annual Cost (\$/year)	Effectiveness and Reliability	Technological Feasibility/ Constructability	Logistics	Reasonability	Substantial Further Study	Environ. Challenges	
Measures in Reducing Source Water Temperature to Belden Forebay											
5a	Modify Canyon Dam low-level outlet to increase Canyon Dam release to 250 cfs or higher	445,000	1,715,000	2,160,000	3	3	3	3	3	3	
	Operate Caribou #1 PH preferentially	0	930,000	930,000	3		3	3	3	3	
	Subtotal	445,000	2,645,000	3,090,000							
5b	Install Caribou Intake thermal curtain	444,000	0	444,000	3	3	3	3	2 (curtain location)	3	
	Modify Canyon Dam low-level outlet to increase Canyon Dam release to 250 cfs or higher	445,000	1,715,000	2,160,000	3	3	3	3	3	3	
	Subtotal	889,000	1,715,000	2,604,000							
5c	Modify Canyon Dam low-level outlet to increase Canyon Dam release to 250 cfs or higher	445,000	1,715,000	2,160,000	3	3	3	3	3	3	
	Construct bypass pipeline to convey Butt Valley PH discharges to 2,000 cfs to Butt Valley Reservoir near Caribou Intakes	7,089,000	474,000	7,563,000		Fail		Fail		Fail	Eliminated ^a
	Subtotal	7,534,000	2,189,000	9,723,000							
Additional Measures for Belden Reach											
(1)	Construct bypass pipeline to convey Seneca Reach flows to 250 cfs to Belden Reservoir for plunging	662,000	0	662,000				Fail			Eliminated ^b
	Install Belden PH Intake thermal curtain	278,000	0	278,000	3	3	3	3	2 (curtain location)	3	
	Construct bypass pipeline to convey warm water to 100 cfs from EBNFFR into upper Rock Creek Reservoir	282,000	0	282,000	3	2 (construction along river)	2 (reg. permitting)	3	2 (pipeline alignment)	2 (construction effects)	
	Subtotal	1,222,000	0	1,222,000							
(2)	Operate Caribou PHs in strict peaking mode with several hours shutdown	0	0	0	3		3	3	3	3	
	Construct bypass pipeline to convey warm water to 100 cfs from EBNFFR into upper Rock Creek Reservoir	282,000	0	282,000	3	2 (construction along river)	2 (reg. permitting)	3	2 (pipeline alignment)	2 (construction effects)	
	Subtotal	282,000	0	282,000							

Table 5-3d Screening of Alternative/ Measures under Alternative Category 5 (Continued)

					Screening Criteria						Evaluation Result
		Amortized Capital and Annual O&M (\$/year)	Energy Replacement Cost (\$/year)	Total Annual Cost (\$/year)	Effectiveness and Reliability	Technological Feasibility/ Constructability	Logistics	Reasonability	Substantial Further Study	Environ. Challenges	
Additional Measures for Rock Creek Reach											
(1)	Construct Yellow Cr/ Belden PH bifurcation or, Convey Yellow Creek flows to 60 cfs by pipeline to Rock Creek Reservoir for plunging				Fail	Fail			Fail	Fail	Eliminated ^c
	Convey lower Belden Reach flows to 140 cfs to Rock Creek Reservoir for plunging										
	Dredge a submerged channel in Rock Creek Reservoir										
	Construct low-level outlet at Rock Creek Dam										
	Subtotal	1,278,000	0	1,278,000							
(2)	Construct bypass pipeline to convey Yellow Creek/ Chips Creek flows to 80 cfs around Rock Creek Reservoir	1,093,000	0	1,093,000		Fail				Fail	Eliminated ^d
(3)	Increase Rock Creek Dam release to 600 cfs	0	1,692,000	1,692,000	2		3	3	3	3	
(4)	Construct 150 cfs capacity water chiller near Rock Creek Dam	485,000	460,000	945,000	3	2	2 (reg. permitting)	1	1 (chiller siting)	1 (air, aesthetic, floodplain)	Eliminated ^e
Additional Measures for Cresta Reach											
(1)	Construct bypass pipeline to convey Bucks Creek PH flows to 140 cfs to Cresta Reservoir for plunging				Fail	Fail			Fail		Eliminated ^f
	Dredge a submerged channel in Cresta Reservoir										
	Construct low-level outlet at Cresta Dam										
	Subtotal	1,529,000	0	1,529,000							
(2)	Construct bypass pipeline to convey Bucks Creek PH flows to 110 cfs around Cresta Reservoir	1,240,000	0	1,240,000		Fail		Fail	Fail		Eliminated ^g
(3)	Increase Cresta Dam release to 700 cfs	0	998,000	998,000	2		3	3	3	3	
(4)	Increase Grizzly Creek release to 100 cfs	0	1,362,000	1,362,000	3		3	3	2 (fish study)	2 (effects on fish)	
(5)	Construct 175 cfs capacity water chiller near Cresta Dam	792,000	722,000	1,514,000				Fail			Eliminated ^h
Additional Measures for Poe Reach											
(1)	Increase Poe Dam release				1		3	3	3	3	
	Construct outlet/pipeline from Poe Adit to release cool water				1	2	3	3	2 (Poe Adit capacity)	3	
	Subtotal **										
(2)	Construct 200 cfs capacity water chiller near Poe Dam	1,052,000	984,000	2,036,000	3	2	2 (reg. permitting)	2 *	1 (chiller siting)	1 (air, aesthetic, floodplain)	

Notes for Table 5-3d:

- a) See the justifications for elimination of Alternative 5c in Section 5.2.
 - b) This measure fails the reasonability criterion because there is another measure, the Caribou PHs ON/OFF peaking operations measure, that is clearly superior to this measure.
 - c) This measure fails the effectiveness and reliability criterion. The measure was designed mainly based on the 2006 special test result in Butt Valley Reservoir demonstrating that the plunged cold water mainly moved in the submerged channel along the bottom in the upper portion of the reservoir with minimal mixing with warm surface water. Further study is required to evaluate the effectiveness and reliability of applying this measure to Rock Creek Reservoir because Rock Creek Reservoir is relatively shallow, has higher flow velocities and, hence, greater mixing potential than Butt Valley Reservoir. This measure also fails the technological feasibility/constructability criterion because it requires setting a 78-inch HDPE along the bottom of upper Rock Creek Reservoir which could be difficult and costly. Design and installation of an anchoring system adequate to withstand the potential forces on the pipe arising from flow momentum and land shifting requires substantial further study. This measure also requires dredging a submerged channel along the bottom of lower Rock Creek Reservoir which could be difficult and costly since it may require removing large boulders. In addition, the dredged conveyance channel at the bottom of Rock Creek Reservoir will likely fill with sediment and require repeated dredging. Directing Yellow Creek/Chips Creek flows into Rock Creek Reservoir poses substantial environmental challenges due to potential effects on fish and regulatory permitting hurdles.
- The measure of conveying Yellow Creek flows by pipeline to Rock Creek Reservoir for plunging is easier and more reliable than the measure of constructing a Yellow Creek/ Belden PH bifurcation.
- d) This measure fails the technological feasibility/constructability criterion. This measure requires attaching a bridge crossing structure and steel pipeline to the existing Highway 70 bridge over Chips Creek, which could make the existing structure unstable. This measure also requires connecting 155 LF of 42-inch Black Steel Pipe to the steep rock face at the dam, which could be difficult and costly. Directing Yellow Creek/Chips Creek flows around Rock Creek Reservoir poses substantial environmental challenges due to potential effects on fish and regulatory permitting hurdles.
 - e) Constructing a water chiller near Rock Creek Dam is relatively unreasonable compared with the increased Rock Creek Dam release measure. Siting the chiller above the 100-year floodplain near the dam requires substantial further study. The chiller may have significant negative impacts on air quality, aesthetic quality, and floodplain.
 - f) Similar to the justifications in c) above, this measure fails the effectiveness and reliability criterion and requires further study because Cresta Reservoir is relatively shallow. This measure also fails the technological feasibility/constructability criterion. This measure requires setting a 54-inch HDPE along the bottom of upper Cresta Reservoir, which could be difficult and costly. Design and installation of an anchoring system adequate to withstand the potential forces on the pipe arising from flow momentum and land shifting requires substantial further study.
 - g) This measure fails the technological feasibility/constructability criterion. This measure requires setting a 48-inch HDPE along the bottom of Cresta Reservoir, which could be difficult and costly. Design and installation of an anchoring system adequate to withstand the potential forces on the pipe arising from flow momentum and land shifting requires substantial further study. This measure also requires tying into the existing submerged 92-inch sluice pipe underwater at the toe of Cresta Dam, which could be difficult and costly due to underwater construction. This measure also fails the reasonability criterion because the increased Grizzly Creek release measure is clearly superior to this measure.
 - h) Constructing a water chiller near Cresta Dam fails the reasonability criterion because the increased Grizzly Creek release measure is clearly superior to constructing a water chiller near Cresta Dam.
- * Poe chiller graded “1” in Alternative Category 4 because there was another superior measure for reducing Poe Reach water temperature. Here, Poe chiller graded “2” because there is no other superior measure.
- ** Cost was not estimated. Further analysis to determine design/operational parameters is required.

Table 5-3e Screening of Alternative/ Measures under Alternative Category 6
(Level 2 screening eliminations identified in red)

Alt.	Measures	Economics			Screening Criteria						Evaluation Result
		Amortized Capital and Annual O&M (\$/year)	Energy Replacement Cost (\$/year)	Total Annual Cost (\$/year)	Effective-ness and Reliability	Technological Feasibility/ Constructability	Logistics	Reasonability	Substantial Further Study	Environ. Challenges	
Measures in Reducing Source Water Temperature to Belden Forebay											
6a	None										
6b	None										
Additional Measures for Belden Reach											
(1)	Modify Canyon Dam Low-Level Outlet to Increase Canyon Dam Release to 250 cfs	445,000	1,715,000	2,160,000	3		3	3	3	3	
	Construct Bypass Pipeline to Convey Seneca Reach Flows (250 cfs) to Belden Reservoir for Plunging and increase Belden Dam release to 250 cfs	662,000	602,000	1,264,000				Fail			
	Construct bypass pipeline to convey warm water to 100 cfs from EBNFFR into upper Rock Creek Reservoir	282,000	0	282,000	3	2 (construction along river)	2 (reg. permitting)	3	2 (pipeline alignment)	2 (construction effects)	
	Subtotal	1,389,000	2,317,000	3,706,000							
(2)	Increase Canyon Dam Low-Level Outlet Release to the Required Minimum Flow 90 cfs	0	0	0	3		3	3	3	3	
	Operate Caribou PHs in Strict Peaking Mode with Several Hours Shutdown	0	0	0	3		3	3	3	3	
	Construct bypass pipeline to convey warm water to 100 cfs from EBNFFR into upper Rock Creek Reservoir	282,000	0	282,000	3	2 (construction along river)	2 (reg. permitting)	3	2 (pipeline alignment)	2 (construction effects)	
	Subtotal	282,000	0	282,000							
Additional Measures for Rock Creek Reach											
(1)	Construct Bypass Pipeline to Convey Lower Belden Reach Flows to 250 cfs around Rock Creek Reservoir	1,064,000	376,000	1,440,000		Fail					Eliminated ^a
(2)	Construct 150 cfs capacity water chiller near Rock Creek Dam	709,000	787,000	1,496,000			Fail				Eliminated ^b
Additional Measures for Cresta Reach											
(1)	Construct Bypass Pipeline to Convey Lower Rock Creek Reach Flows to 250 cfs around Cresta Reservoir	1,138,000	142,000	1,280,000		Fail					Eliminated ^a
(2)	Construct 175 cfs capacity water chiller near Cresta Dam	971,000	984,000	1,955,000			Fail				Eliminated ^b
Additional Measures for Poe Reach											
(1)	Construct Bypass Pipeline to Convey Lower Cresta Reach Flows to 250 cfs around Poe Reservoir	912,000	157,000	1,069,000		Fail					Eliminated ^a
(2)	Construct 200 cfs capacity water chiller near Poe Dam	1,366,000	1,444,000	2,810,000			Fail				Eliminated ^b

a) See the justifications for elimination of Alternative 6a in Section 5.2.

b) See the justifications for elimination of Alternative 6b in Section 5.2.

Final Level 2 Water Temperature Reduction Alternatives

The resulting final Level 2 water temperature reduction alternatives are summarized in Table 5-4. Consistent with the framework described in Chapter 3 and discussions in Section 4.1 of Chapter 4, Table 5-4 shows alternative categories, alternatives, and variations for cooling downstream reaches. The shaded cells represent alternatives/measures advanced to Level 3 (green); or eliminated (gray). The alternative categories are differentiated by the amount of temperature reduction at Belden Reservoir. Within a particular category, alternatives are differentiated by the method of temperature reduction at Belden Reservoir. An alternative may have multiple variations with respect to the method of temperature reduction in downstream reaches. The following alternatives with variations remain and will advance to Level 3 for further refinement, analysis, and screening.

- Alternative Category 2 – one alternative (Alternative 2c) with one variation for the Poe Reach. No water temperature reduction measures are needed for the Belden, Rock Creek, and Cresta Reaches. This Category has one alternative variation (i.e., $1 \times 1 = 1$).
- Alternative Category 3 – one alternative (Alternative 3) with one variation for each of the Belden, Cresta, and Poe Reaches. No water temperature reduction measures are needed for the Rock Creek Reach. This Category has one alternative variation (i.e., $1 \times 1 \times 1 = 1$).
- Alternative Category 4 – three alternatives (Alternatives 4a, 4b, and 4c) with one variation for the Belden Reach, one variation for the Rock Creek Reach, two variations for the Cresta Reach, and one variation for the Poe Reach, totaling 6 alternative variations (i.e., $3 \times 1 \times 1 \times 2 \times 1 = 6$).
- Alternative Category 5 – two alternatives (Alternatives 5a and 5b) with one variation for the Belden Reach, one variation for the Rock Creek Reach, two variations for the Cresta Reach, and two variations for the Poe Reach, totaling 8 alternative variations (i.e., $2 \times 1 \times 1 \times 2 \times 2 = 8$).

These water temperature reduction alternatives are recommended for further analysis and evaluation in Level 3. The “Alternatives Development and Evaluation Process Flow Diagram”, updated to reflect the results of Level 2 screening, is presented in Figure 5-8.

Table 5-4 Final Level 2 Alternatives to Achieve the 20°C Objective Target for Water Temperature along the NFFR

(Green highlighted measures remain as final Level 2 Alternatives and will advance to Level 3; Bright green highlighted measures represent variations for cooling downstream reaches)

Alternative Category	Alternative		Variations for Cooling Downstream Reaches			
	Alt.	Measures in reducing source water temperature to Belden Forebay	Additional measures for Belden Reach	Additional measures for Rock Creek Reach	Additional measures for Cresta Reach	Additional measures for Poe Reach
1. Reduce the temperature in Belden Forebay to 12.5 °C. (eliminated)	1	<ul style="list-style-type: none"> Install Prattville thermal curtain with levee removed Collect and convey cold spring water (215 cfs, 8°C) to Prattville Intake Convey Butt Valley PH discharges to Butt Valley Reservoir near Caribou Intake 	No	No	No	No
2. Reduce the temperature in Belden Forebay to 14.5 °C. (1 variation)	2a	<ul style="list-style-type: none"> Install Prattville thermal curtain with levee removed Convey Butt Valley PH discharges to 2,000 cfs to Butt Valley Reservoir near Caribou Intake 	No	No	No	<ul style="list-style-type: none"> Increase shading along Poe Reach
	2b	<ul style="list-style-type: none"> Install Prattville thermal curtain with levee removed Install a thermal curtain near Caribou Intake in Butt Valley Reservoir Collect and convey cold spring water (215 cfs, 8°C) to Prattville Intake 				<ul style="list-style-type: none"> Increase Poe Dam release to 360 cfs
	2c	<ul style="list-style-type: none"> Decrease Prattville Intake release to 500 cfs to cause cold water selective withdrawal Extend the existing deeper channel of Butt Valley Reservoir by dredging Use Caribou #1 exclusively with reduced release to cause cold water selective withdrawal Repair/modify Canyon Dam low level outlet and increase release to 600 cfs 				<ul style="list-style-type: none"> Construct outlet/pipeline from the Poe Adit and release to 180 cfs the cooler water to the Poe Reach
3. Reduce the temperature in Belden Forebay to 16.0 °C. (1 variation)	3	<ul style="list-style-type: none"> Install Prattville thermal curtain with levee removed Install a thermal curtain near Caribou Intake in Butt Valley Reservoir Increase Canyon Dam release to 250 cfs (and decrease Prattville Intake release commensurately) 	<ul style="list-style-type: none"> Convey warm water to 100 cfs in East Branch NFFR to Rock Creek Reservoir by diversion/pipeline <p>Note: This measure is designed to protect the lower Belden Reach</p>	No	<ul style="list-style-type: none"> Increase Cresta Dam release to 390 cfs 	<ul style="list-style-type: none"> Increase Poe Dam release to 300 cfs Construct outlet/pipeline from the Poe Adit and release to 400 cfs the cooler water to the Poe Reach
					<ul style="list-style-type: none"> Increase Grizzly Creek release to 50 cfs 	

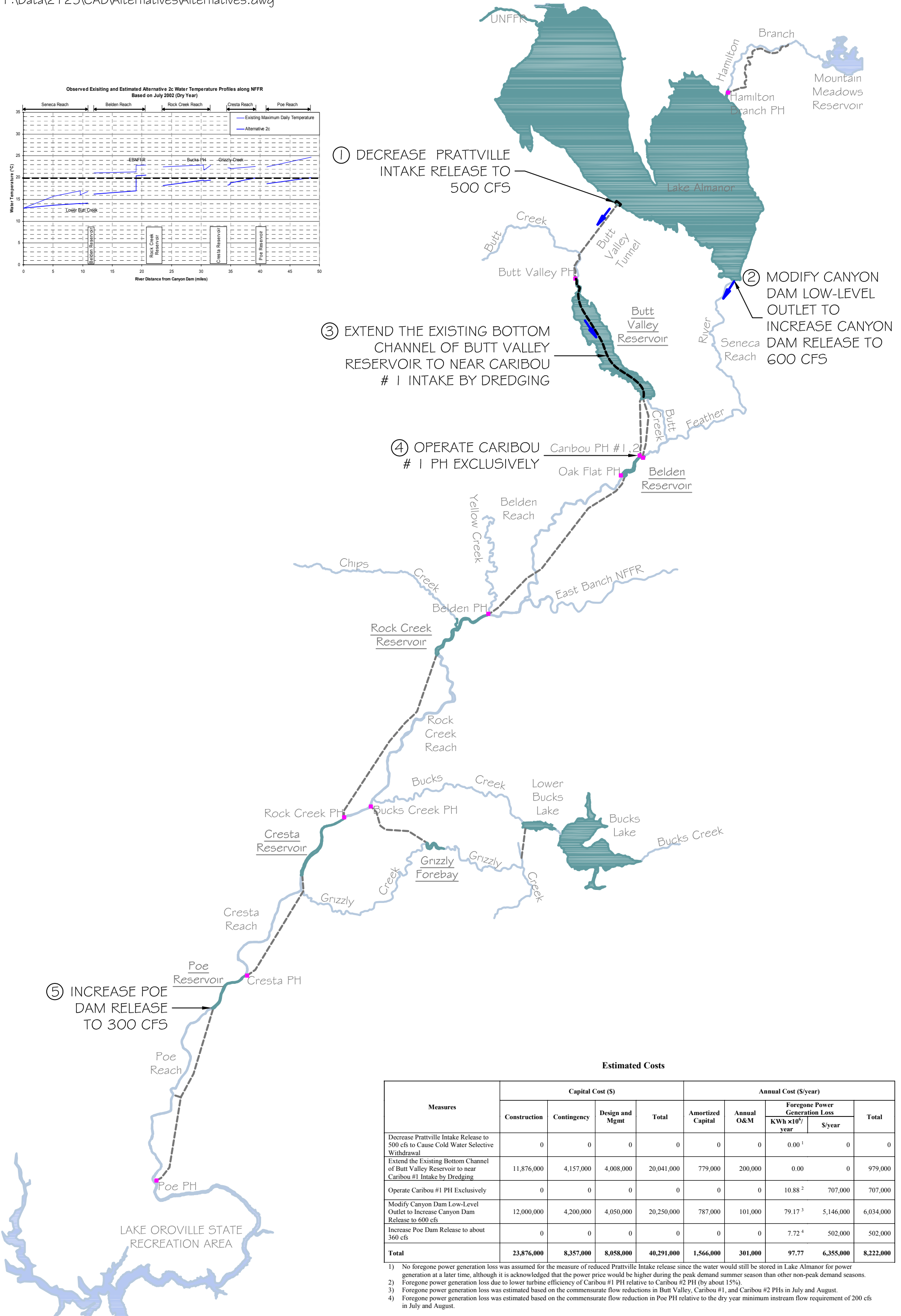
Note: All alternatives will have no affect on Lake Almanor water levels except Alternative 2c which would result in higher than historical lake levels due to significant flow reduction at the Prattville Intake.

Table 5-4 Final Level 2 Alternatives to Achieve the 20°C Objective Target for Water Temperature along the NFFR (Continued)

Alternative Category	Alternative		Variations for Cooling Downstream Reaches			
	Alt.	Measures in reducing source water temperature to Belden Forebay	Additional measures for Belden Reach	Additional measures for Rock Creek Reach	Additional measures for Cresta Reach	Additional measures for Poe Reach
4. Reduce the temperature in Belden Forebay to 18.0 °C. (6 variations)	4a	<ul style="list-style-type: none"> Install Prattville thermal curtain Install a thermal curtain near Caribou Intake in Butt Valley Reservoir 	<ul style="list-style-type: none"> Convey warm water to 100 cfs in East Branch NFFR to Rock Creek Reservoir by diversion/pipeline <p>Note: This measure is designed to protect the lower Belden Reach.</p>	<ul style="list-style-type: none"> Construct Yellow Cr/ Belden PH bifurcation or, Convey Yellow Creek flows to 60 cfs by pipeline to Rock Creek Reservoir for plunging Construct low level outlet at Rock Creek Dam Dredge a submerged channel in Rock Creek Reservoir 	<ul style="list-style-type: none"> Convey cold Bucks Creek PH flows to 140 cfs to Cresta Reservoir for plunging by pipeline Construct low level outlet at Cresta Dam 	<ul style="list-style-type: none"> Increase Poe Dam release to 400 cfs Construct outlet/pipeline from the Poe Adit and release to 450 cfs the cooler water to the Poe Reach
	4b	<ul style="list-style-type: none"> Install Prattville thermal curtain Use Caribou #1 preferentially over Caribou #2 		<ul style="list-style-type: none"> Bypass Yellow Creek flows to 60 cfs around Rock Creek Reservoir by diversion/pipeline 	<ul style="list-style-type: none"> Bypass cold Bucks Creek PH flows to 95 cfs around Cresta Reservoir by diversion/pipeline 	
	4c	<ul style="list-style-type: none"> Repair/modify Canyon Dam low level outlet and increase release to 600 cfs (and decrease Prattville Intake release commensurately) Use Caribou #1 preferentially over Caribou #2 		<ul style="list-style-type: none"> Increase Rock Creek Dam release to 400 cfs 	<ul style="list-style-type: none"> Increase Cresta Dam release to 500 cfs Increase Grizzly Creek releases to 80 cfs 	<ul style="list-style-type: none"> Construct 200 cfs capacity water chiller at Poe Dam
5. Reduce the temperature in Belden Forebay to 19.5 °C. (8 variations)	5a	<ul style="list-style-type: none"> Use Caribou #1 preferentially over Caribou #2 Repair/modify Canyon Dam low level outlet and increase release to 250 cfs or higher (and decrease Prattville Intake release commensurately) 	<ul style="list-style-type: none"> Convey cold Seneca Reach flows to 250 cfs to Belden Reservoir for plunging by diversion/pipeline Install a thermal curtain near Belden PH Intake Convey warm water to 100 cfs in East Branch NFFR to Rock Creek Reservoir by diversion/pipeline 	<ul style="list-style-type: none"> Construct Yellow Cr/ Belden PH bifurcation or, Convey Yellow Creek flows to 60 cfs by pipeline to Rock Creek Reservoir for plunging Convey lower Belden Reach flows to 140 cfs to Rock Creek Reservoir for plunging Dredge a submerged channel in Rock Creek Reservoir Construct low level outlet at Rock Creek Dam 	<ul style="list-style-type: none"> Convey cold Bucks Creek PH flows to 140 cfs to Cresta Reservoir for plunging by diversion/pipeline Dredge a submerged channel in Cresta Reservoir Construct low level outlet at Cresta Dam 	
	5b	<ul style="list-style-type: none"> Install thermal curtain near Caribou Intake in Butt Valley Reservoir Repair/modify Canyon Dam low level outlet and increase release to 250 cfs or higher (and decrease Prattville Intake release commensurately) 		<ul style="list-style-type: none"> Bypass Yellow Creek/Chips Creek flows to 80 cfs around Rock Creek Reservoir by diversion/pipeline 	<ul style="list-style-type: none"> Bypass cold Bucks Creek PH flows to 110 cfs around Cresta Reservoir by pipeline 	
	5c	<ul style="list-style-type: none"> Convey Butt Valley PH discharges to 2,000 cfs by pipeline to Butt Valley Res. near the Caribou Intake Repair/modify Canyon Dam low level outlet and increase release to 250 cfs or higher (and decrease Prattville Intake release commensurately) 		<ul style="list-style-type: none"> Operate Caribou PHs in strict peaking mode with several hours shut down Convey warm water to 100 cfs in East Branch NFFR to Rock Creek Reservoir by diversion/pipeline 	<ul style="list-style-type: none"> Increase Rock Creek Dam release to 600 cfs 	<ul style="list-style-type: none"> Increase Cresta Dam release to 700 cfs Increase Grizzly Creek releases to 100 cfs
			<ul style="list-style-type: none"> Construct 150 cfs capacity water chiller at Rock Creek Dam 	<ul style="list-style-type: none"> Construct 175 cfs capacity water chiller at Cresta Dam 		

**Table 5-4 Final Level 2 Alternatives to Achieve the 20°C Objective Target for Water Temperature along the NFFR
(Continued)**

Alternative Category	Alternative		Variations for Cooling Downstream Reaches			
	Alt.	Measures in reducing source water temperature to Belden Forebay	Additional measures for Belden Reach	Additional measures for Rock Creek Reach	Additional measures for Cresta Reach	Additional measures for Poe Reach
6. Reduce temperatures in all downstream reaches. (eliminated)	6a	No	<ul style="list-style-type: none"> Repair/modify Canyon Dam low level outlet and increase release to 250 cfs Convey cold Seneca Reach flows to Belden Reservoir for plunging by diversion/pipeline Increase Belden Dam/Oak Flat PH release to 250 cfs Convey warm water to 100 cfs in East Branch NFFR to Rock Creek Reservoir by diversion/pipeline 	<ul style="list-style-type: none"> Bypass lower Belden Reach flows to 250 cfs around Rock Creek Reservoir by diversion/pipeline <p>Note: Must be combined with bypassing Seneca flows around Belden Reservoir.</p>	<ul style="list-style-type: none"> Bypass lower Rock Creek Reach flows to 250 cfs around Cresta Reservoir by diversion/pipeline <p>Note: Must be combined with bypassing Seneca flows around Belden Reservoir.</p>	<ul style="list-style-type: none"> Bypass lower Cresta Reach flows to 250 cfs around Poe Reservoir by diversion/ pipeline <p>Note: Must be combined with bypassing Seneca flows around Belden Reservoir.</p>
	6b		<ul style="list-style-type: none"> Increase Canyon Dam low level outlet release to 90 cfs or higher Operate Caribou PHs in strict peaking mode with several hours shut down Convey warm water to 100 cfs in East Branch NFFR to Rock Creek Reservoir by diversion/pipeline 	<ul style="list-style-type: none"> Construct 150 cfs capacity water chiller at Rock Creek Dam 	<ul style="list-style-type: none"> Construct 175 cfs capacity water chiller at Cresta Dam 	<ul style="list-style-type: none"> Construct 200 cfs capacity water chiller at Poe Dam
	6c		<ul style="list-style-type: none"> Convey cold water from Lake Oroville to below Belden Dam 	<ul style="list-style-type: none"> Convey cold water from Lake Oroville to below Rock Creek Dam 	<ul style="list-style-type: none"> Convey cold water from Lake Oroville to below Cresta Dam 	<ul style="list-style-type: none"> Convey cold Lake Oroville to below Poe D.



Estimated Costs

Measures	Capital Cost (\$)				Annual Cost (\$/year)				
	Construction	Contingency	Design and Mgmt	Total	Amortized Capital	Annual O&M	Foregone Power Generation Loss		Total
							KWh x10 ⁶ /year	\$/year	
Decrease Prattville Intake Release to 500 cfs to Cause Cold Water Selective Withdrawal	0	0	0	0	0	0	0.00 ¹	0	0
Extend the Existing Bottom Channel of Butt Valley Reservoir to near Caribou #1 Intake by Dredging	11,876,000	4,157,000	4,008,000	20,041,000	779,000	200,000	0.00	0	979,000
Operate Caribou #1 PH Exclusively	0	0	0	0	0	0	10.88 ²	707,000	707,000
Modify Canyon Dam Low-Level Outlet to Increase Canyon Dam Release to 600 cfs	12,000,000	4,200,000	4,050,000	20,250,000	787,000	101,000	79.17 ³	5,146,000	6,034,000
Increase Poe Dam Release to about 360 cfs	0	0	0	0	0	0	7.72 ⁴	502,000	502,000
Total	23,876,000	8,357,000	8,058,000	40,291,000	1,566,000	301,000	97.77	6,355,000	8,222,000

1) No foregone power generation loss was assumed for the measure of reduced Prattville Intake release since the water would still be stored in Lake Almanor for power generation at a later time, although it is acknowledged that the power price would be higher during the peak demand summer season than other non-peak demand seasons.
 2) Foregone power generation loss due to lower turbine efficiency of Caribou #1 PH relative to Caribou #2 PH (by about 15%).
 3) Foregone power generation loss was estimated based on the commensurate flow reductions in Butt Valley, Caribou #1, and Caribou #2 PHs in July and August.
 4) Foregone power generation loss was estimated based on the commensurate flow reduction in Poe PH relative to the dry year minimum instream flow requirement of 200 cfs in July and August.

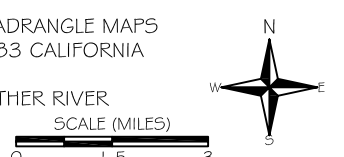


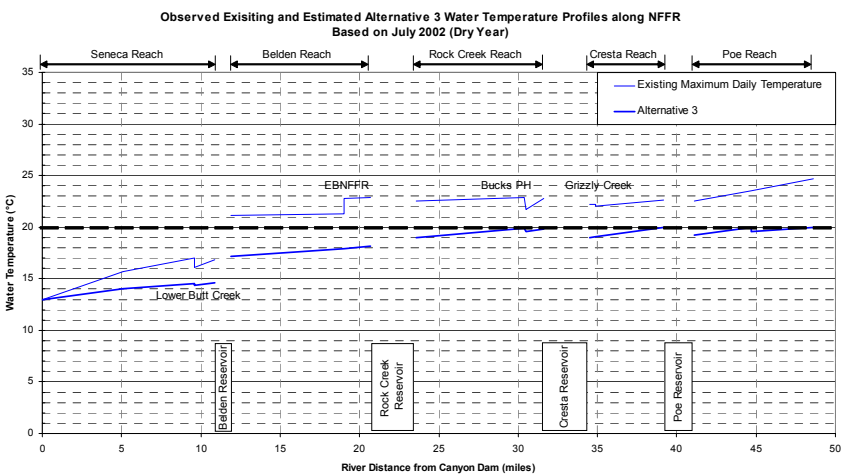
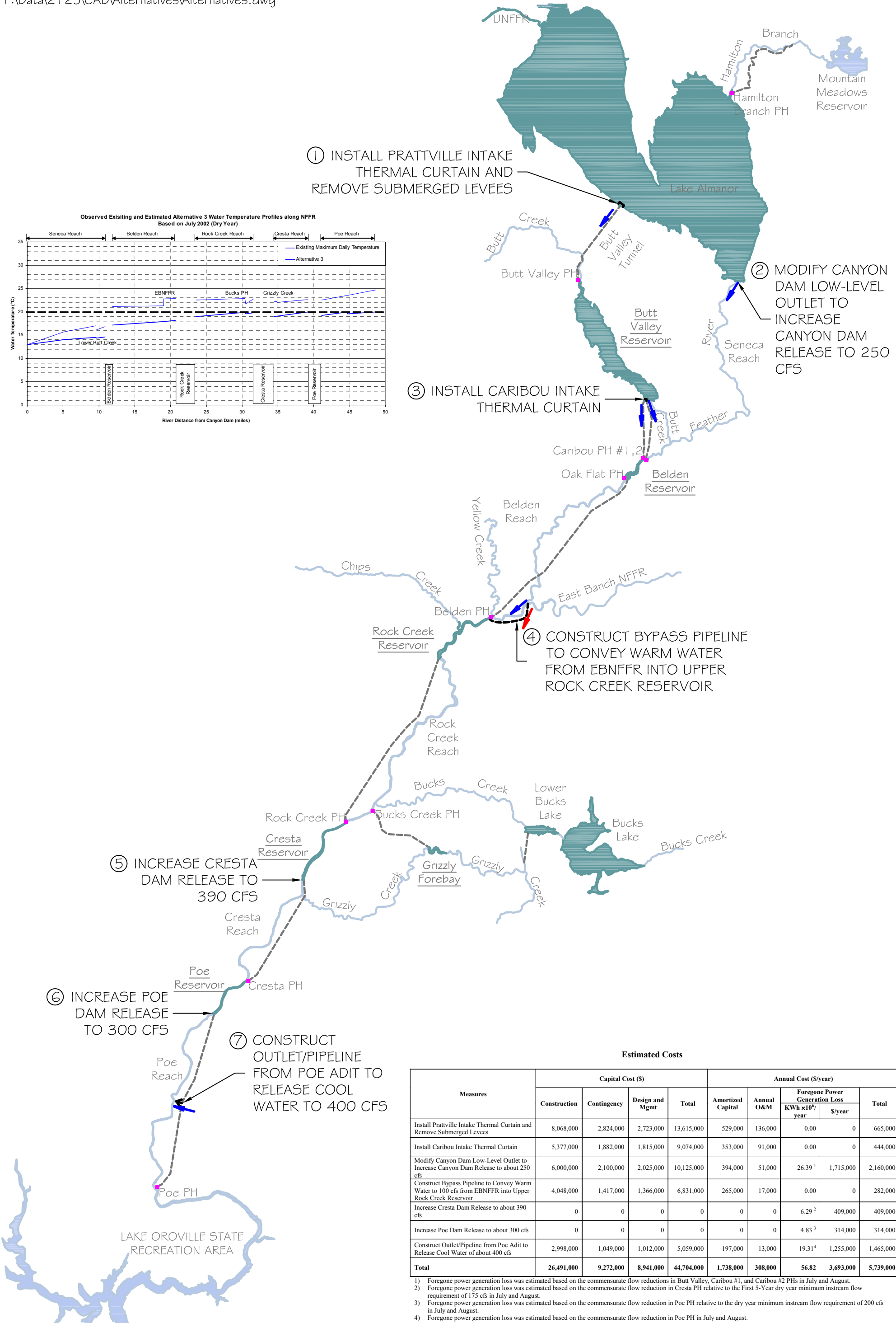
FIGURE 5-1
ALTERNATIVE 2C

- LEGEND**
- COOL WATER INFUSION
 - WARM WATER
 - STREAM
 - POWERHOUSE CONDUIT
 - POWERHOUSE (PH)
 - NEW OR MODIFIED FACILITY

NOTES:

1. SOURCE: USGS 7.5 MINUTE QUADRANGLE MAPS (PROJECTION: STATE PLANE NAD83 CALIFORNIA ZONE 1 IN FEET)
2. UNFFR: UPPER NORTH FORK FEATHER RIVER





Estimated Costs

Measures	Capital Cost (\$)				Annual Cost (\$/year)				
	Construction	Contingency	Design and Mgmt	Total	Amortized Capital	Annual O&M	Foregone Power Generation Loss		
							KWh x10 ⁷ /year	\$/year	Total
Install Prattville Intake Thermal Curtain and Remove Submerged Levees	8,068,000	2,824,000	2,723,000	13,615,000	529,000	136,000	0.00	0	665,000
Install Caribou Intake Thermal Curtain	5,377,000	1,882,000	1,815,000	9,074,000	353,000	91,000	0.00	0	444,000
Modify Canyon Dam Low-Level Outlet to Increase Canyon Dam Release to about 250 cfs	6,000,000	2,100,000	2,025,000	10,125,000	394,000	51,000	26.39 ¹	1,715,000	2,160,000
Construct Bypass Pipeline to Convey Warm Water to 100 cfs from EBNFFR into Upper Rock Creek Reservoir	4,048,000	1,417,000	1,366,000	6,831,000	265,000	17,000	0.00	0	282,000
Increase Cresta Dam Release to about 390 cfs	0	0	0	0	0	0	6.29 ²	409,000	409,000
Increase Poe Dam Release to about 300 cfs	0	0	0	0	0	0	4.83 ³	314,000	314,000
Construct Outlet/Pipeline from Poe Adit to Release Cool Water of about 400 cfs	2,998,000	1,049,000	1,012,000	5,059,000	197,000	13,000	19.31 ⁴	1,255,000	1,465,000
Total	26,491,000	9,272,000	8,941,000	44,704,000	1,738,000	308,000	56.82	3,693,000	5,739,000

1) Foregone power generation loss was estimated based on the commensurate flow reductions in Butt Valley, Caribou #1, and Caribou #2 PHs in July and August.
 2) Foregone power generation loss was estimated based on the commensurate flow reduction in Cresta PH relative to the First 5-Year dry year minimum instream flow requirement of 175 cfs in July and August.
 3) Foregone power generation loss was estimated based on the commensurate flow reduction in Poe PH relative to the dry year minimum instream flow requirement of 200 cfs in July and August.
 4) Foregone power generation loss was estimated based on the commensurate flow reduction in Poe PH in July and August.



FIGURE 5-2
ALTERNATIVE 3

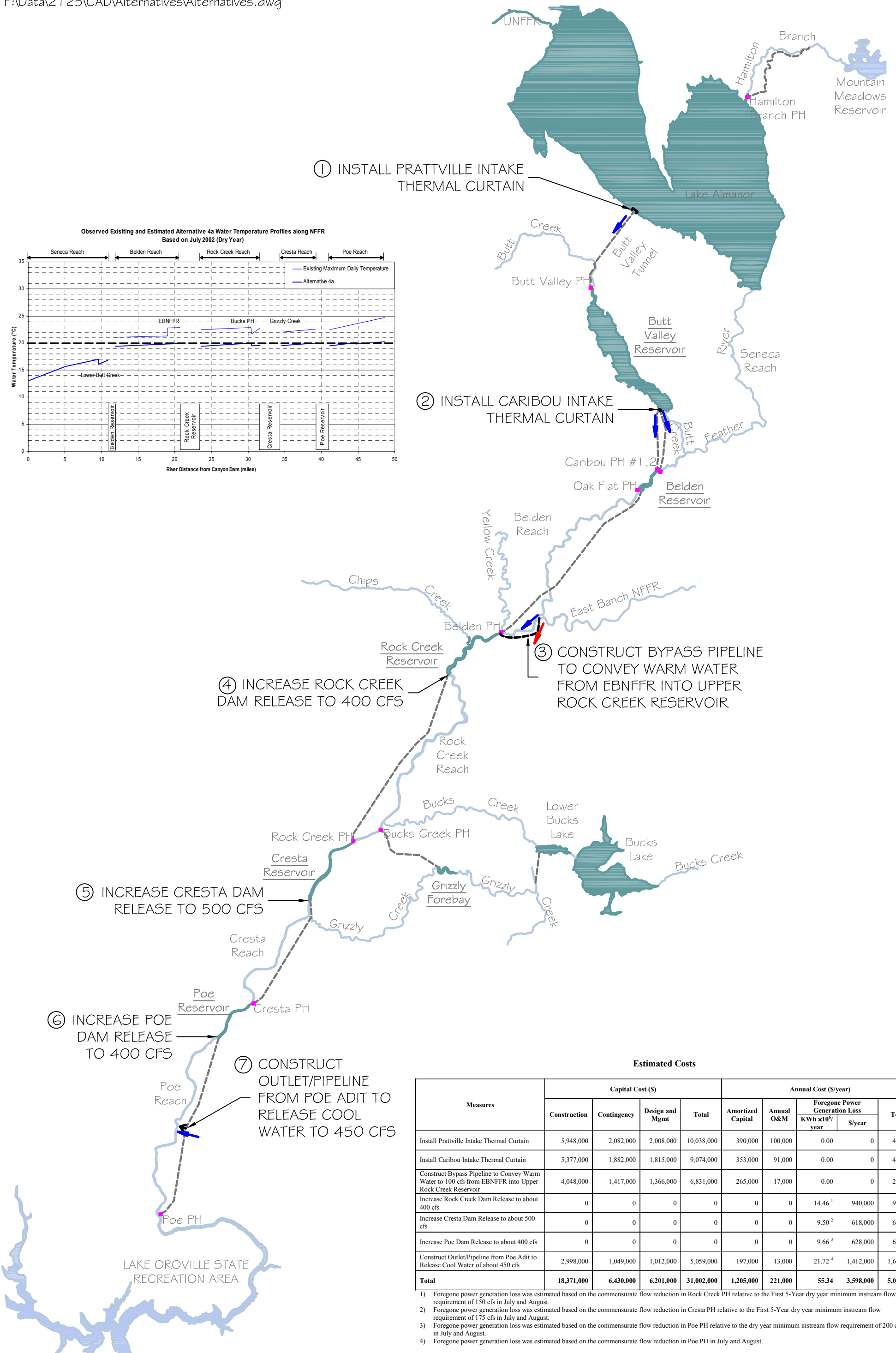
LEGEND

- COOL WATER INFUSION
- WARM WATER
- STREAM
- - - POWERHOUSE CONDUIT
- POWERHOUSE (PH)
- - - NEW OR MODIFIED FACILITY

NOTES:

- SOURCE: USGS 7.5 MINUTE QUADRANGLE MAPS (PROJECTION: STATE PLANE NAD83 CALIFORNIA ZONE I IN FEET)
- UNFFR: UPPER NORTH FORK FEATHER RIVER

SCALE (MILES)



Estimated Costs

Measures	Capital Cost (\$)				Annual Cost (\$/year)				
	Construction	Contingency	Design and Mgmt	Total	Amortized Capital	Annual O&M	Foregone Power Generation Loss		Total
							KWh x10 ⁶ /year	\$/year	
Install Prattville Intake Thermal Curtain	5,948,000	2,082,000	2,008,000	10,038,000	390,000	100,000	0.00	0	490,000
Install Caribou Intake Thermal Curtain	5,377,000	1,882,000	1,815,000	9,074,000	353,000	91,000	0.00	0	444,000
Construct Bypass Pipeline to Convey Warm Water to 100 cfs from EBNFFR into Upper Rock Creek Reservoir	4,048,000	1,417,000	1,366,000	6,831,000	265,000	17,000	0.00	0	282,000
Increase Rock Creek Dam Release to about 400 cfs	0	0	0	0	0	0	14.46 ¹	940,000	940,000
Increase Cresta Dam Release to about 500 cfs	0	0	0	0	0	0	9.50 ²	618,000	618,000
Increase Poe Dam Release to about 400 cfs	0	0	0	0	0	0	9.66 ³	628,000	628,000
Construct Outlet/Pipeline from Poe Adit to Release Cool Water of about 450 cfs	2,998,000	1,049,000	1,012,000	5,059,000	197,000	13,000	21.72 ⁴	1,412,000	1,622,000
Total	18,371,000	6,430,000	6,201,000	31,002,000	1,205,000	221,000	55.34	3,598,000	5,024,000

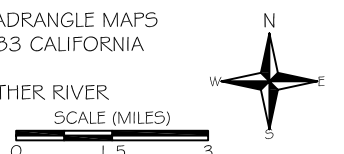
1) Foregone power generation loss was estimated based on the commensurate flow reduction in Rock Creek PH relative to the First 5-Year dry year minimum instream flow requirement of 150 cfs in July and August.
 2) Foregone power generation loss was estimated based on the commensurate flow reduction in Cresta PH relative to the First 5-Year dry year minimum instream flow requirement of 175 cfs in July and August.
 3) Foregone power generation loss was estimated based on the commensurate flow reduction in Poe PH relative to the dry year minimum instream flow requirement of 200 cfs in July and August.
 4) Foregone power generation loss was estimated based on the commensurate flow reduction in Poe PH in July and August.

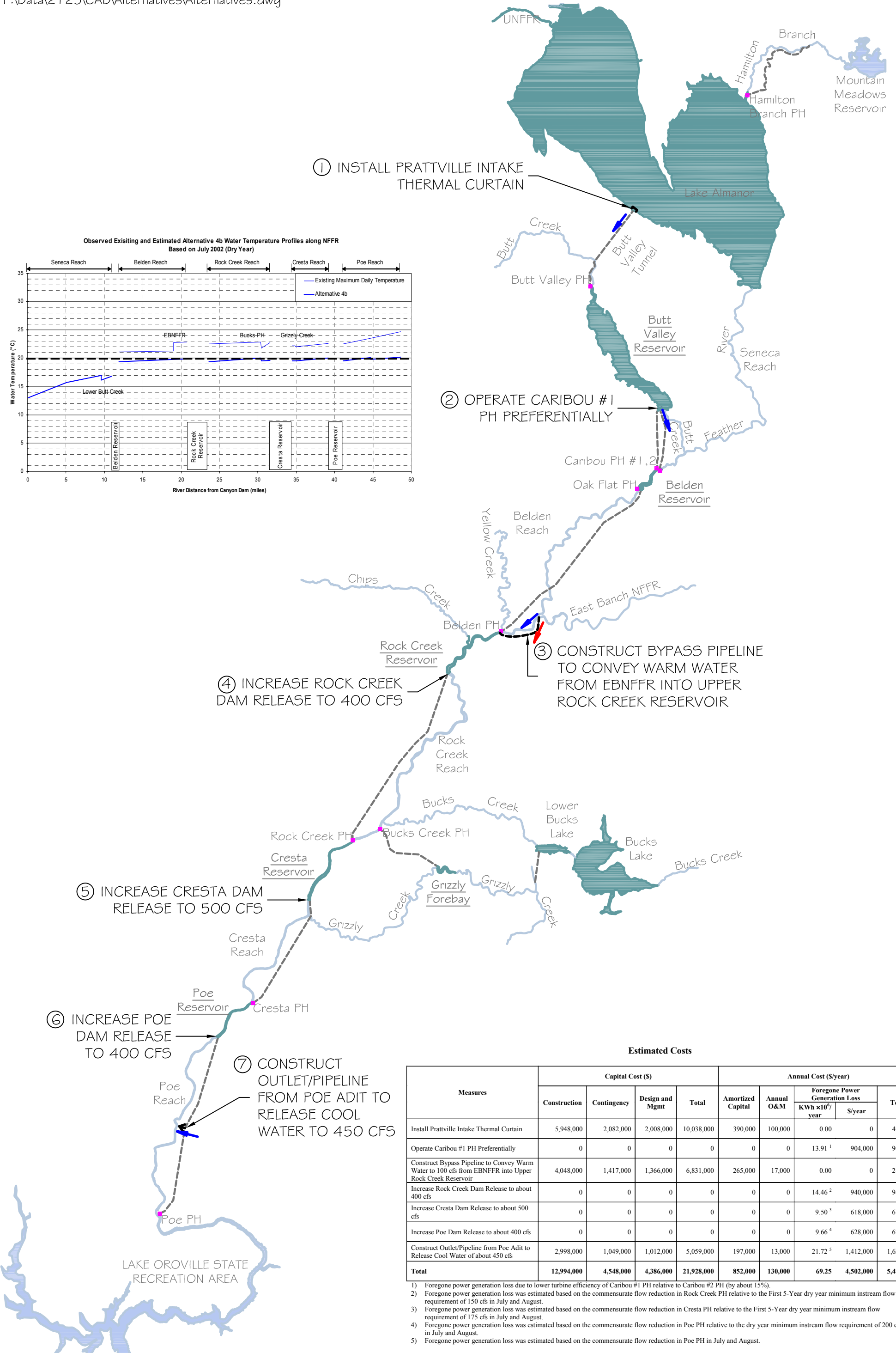
FIGURE 5-3
ALTERNATIVE 4A



- LEGEND**
- COOL WATER INFUSION
 - WARM WATER
 - STREAM
 - POWERHOUSE CONDUIT
 - POWERHOUSE (PH)
 - NEW OR MODIFIED FACILITY

- NOTES:**
1. SOURCE: USGS 7.5 MINUTE QUADRANGLE MAPS (PROJECTION: STATE PLANE NAD83 CALIFORNIA ZONE 1 IN FEET)
 2. UNFFR: UPPER NORTH FORK FEATHER RIVER





Estimated Costs

Measures	Capital Cost (\$)				Annual Cost (\$/year)				
	Construction	Contingency	Design and Mgmt	Total	Amortized Capital	Annual O&M	Foregone Power Generation Loss		Total
							KWh x10 ⁶ /year	\$/year	
Install Prattville Intake Thermal Curtain	5,948,000	2,082,000	2,008,000	10,038,000	390,000	100,000	0.00	0	490,000
Operate Caribou #1 PH Preferentially	0	0	0	0	0	0	13.91 ¹	904,000	904,000
Construct Bypass Pipeline to Convey Warm Water to 100 cfs from EBNFFR into Upper Rock Creek Reservoir	4,048,000	1,417,000	1,366,000	6,831,000	265,000	17,000	0.00	0	282,000
Increase Rock Creek Dam Release to about 400 cfs	0	0	0	0	0	0	14.46 ²	940,000	940,000
Increase Cresta Dam Release to about 500 cfs	0	0	0	0	0	0	9.50 ³	618,000	618,000
Increase Poe Dam Release to about 400 cfs	0	0	0	0	0	0	9.66 ⁴	628,000	628,000
Construct Outlet/Pipeline from Poe Adit to Release Cool Water of about 450 cfs	2,998,000	1,049,000	1,012,000	5,059,000	197,000	13,000	21.72 ⁵	1,412,000	1,622,000
Total	12,994,000	4,548,000	4,386,000	21,928,000	852,000	130,000	69.25	4,502,000	5,484,000

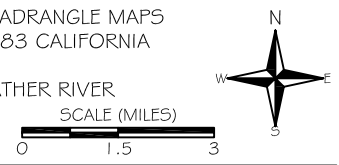
1) Foregone power generation loss due to lower turbine efficiency of Caribou #1 PH relative to Caribou #2 PH (by about 15%).
 2) Foregone power generation loss was estimated based on the commensurate flow reduction in Rock Creek PH relative to the First 5-Year dry year minimum instream flow requirement of 150 cfs in July and August.
 3) Foregone power generation loss was estimated based on the commensurate flow reduction in Cresta PH relative to the First 5-Year dry year minimum instream flow requirement of 175 cfs in July and August.
 4) Foregone power generation loss was estimated based on the commensurate flow reduction in Poe PH relative to the dry year minimum instream flow requirement of 200 cfs in July and August.
 5) Foregone power generation loss was estimated based on the commensurate flow reduction in Poe PH in July and August.

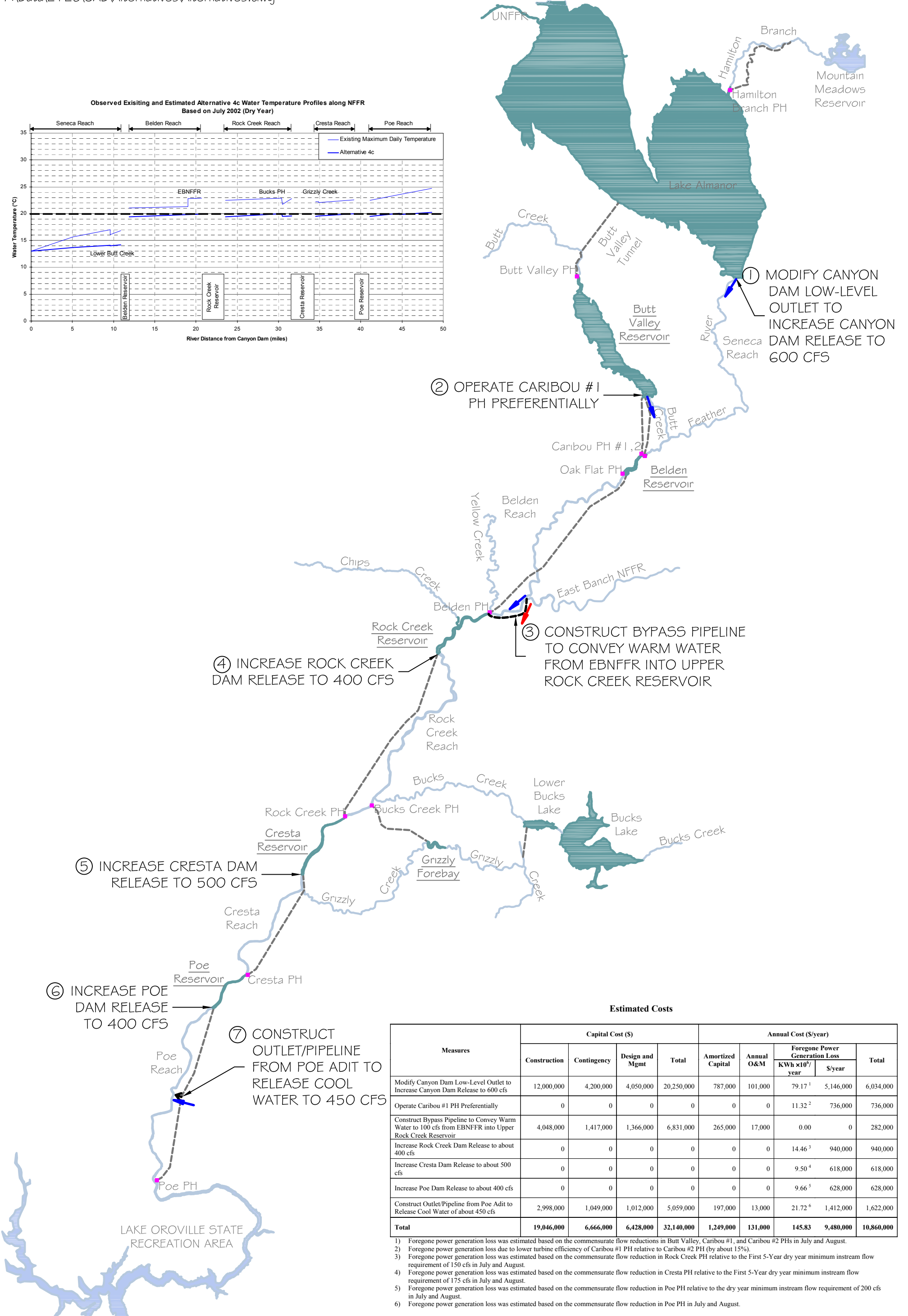


FIGURE 5-4
ALTERNATIVE 4B

- LEGEND**
- COOL WATER INFUSION
 - WARM WATER
 - STREAM
 - POWERHOUSE CONDUIT
 - POWERHOUSE (PH)
 - NEW OR MODIFIED FACILITY

- NOTES:**
1. SOURCE: USGS 7.5 MINUTE QUADRANGLE MAPS (PROJECTION: STATE PLANE NAD83 CALIFORNIA ZONE 1 IN FEET)
 2. UNFFR: UPPER NORTH FORK FEATHER RIVER





Estimated Costs

Measures	Capital Cost (\$)				Annual Cost (\$/year)				
	Construction	Contingency	Design and Mgmt	Total	Amortized Capital	Annual O&M	Foregone Power Generation Loss		Total
							KWh x10 ⁷ /year	\$/year	
Modify Canyon Dam Low-Level Outlet to Increase Canyon Dam Release to 600 cfs	12,000,000	4,200,000	4,050,000	20,250,000	787,000	101,000	79.17 ¹	5,146,000	6,034,000
Operate Caribou #1 PH Preferentially	0	0	0	0	0	0	11.32 ²	736,000	736,000
Construct Bypass Pipeline to Convey Warm Water to 100 cfs from EBNFFR into Upper Rock Creek Reservoir	4,048,000	1,417,000	1,366,000	6,831,000	265,000	17,000	0.00	0	282,000
Increase Rock Creek Dam Release to about 400 cfs	0	0	0	0	0	0	14.46 ³	940,000	940,000
Increase Cresta Dam Release to about 500 cfs	0	0	0	0	0	0	9.50 ⁴	618,000	618,000
Increase Poe Dam Release to about 400 cfs	0	0	0	0	0	0	9.66 ⁵	628,000	628,000
Construct Outlet/Pipeline from Poe Adit to Release Cool Water of about 450 cfs	2,998,000	1,049,000	1,012,000	5,059,000	197,000	13,000	21.72 ⁶	1,412,000	1,622,000
Total	19,046,000	6,666,000	6,428,000	32,140,000	1,249,000	131,000	145.83	9,480,000	10,860,000

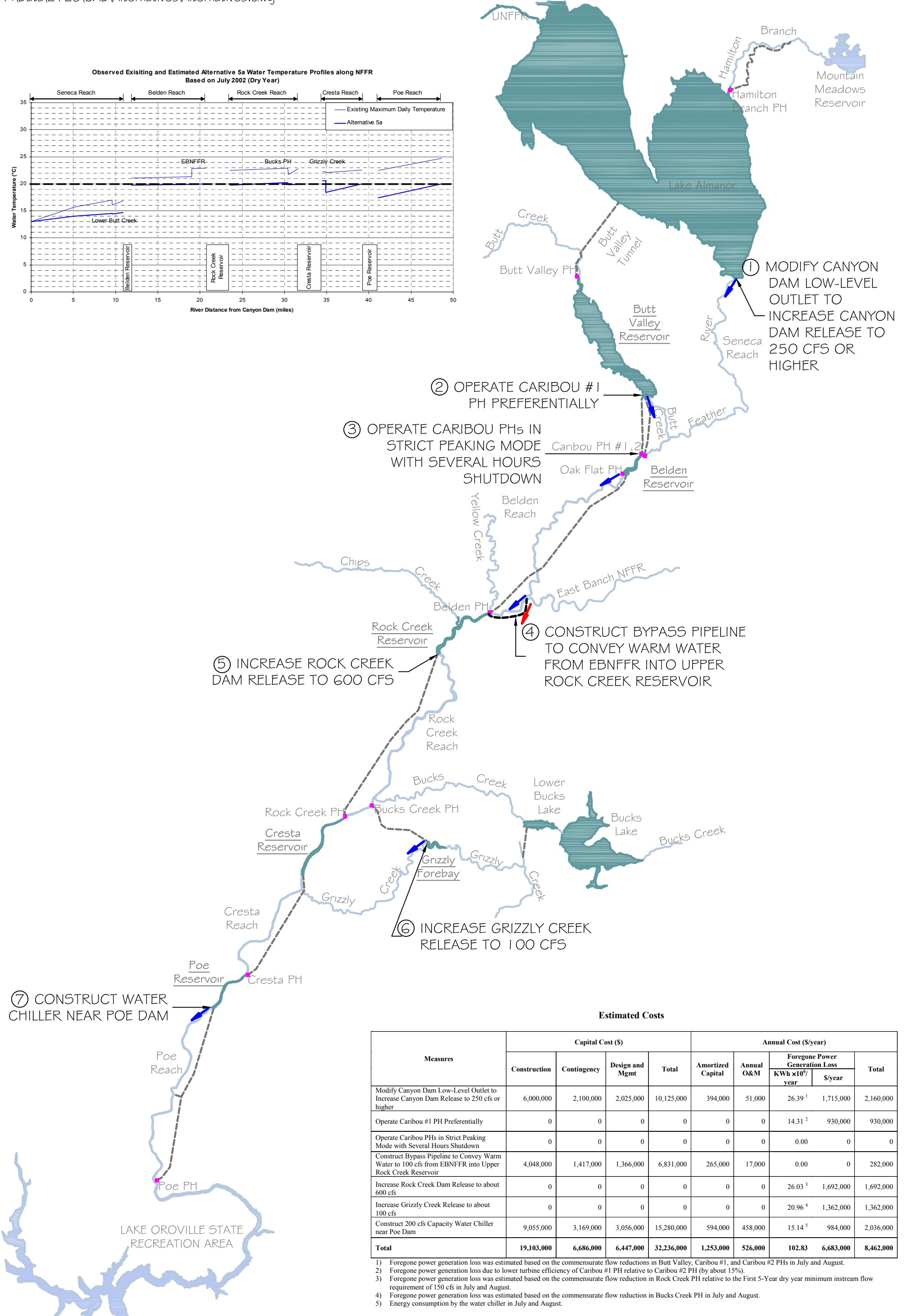
- 1) Foregone power generation loss was estimated based on the commensurate flow reductions in Butte Valley, Caribou #1, and Caribou #2 PHs in July and August.
- 2) Foregone power generation loss due to lower turbine efficiency of Caribou #1 PH relative to Caribou #2 PH (by about 15%).
- 3) Foregone power generation loss was estimated based on the commensurate flow reduction in Rock Creek PH relative to the First 5-Year dry year minimum instream flow requirement of 150 cfs in July and August.
- 4) Foregone power generation loss was estimated based on the commensurate flow reduction in Cresta PH relative to the First 5-Year dry year minimum instream flow requirement of 175 cfs in July and August.
- 5) Foregone power generation loss was estimated based on the commensurate flow reduction in Poe PH relative to the dry year minimum instream flow requirement of 200 cfs in July and August.
- 6) Foregone power generation loss was estimated based on the commensurate flow reduction in Poe PH in July and August.



FIGURE 5-5
ALTERNATIVE 4C

- LEGEND**
- COOL WATER INFUSION
 - WARM WATER
 - STREAM
 - POWERHOUSE CONDUIT
 - POWERHOUSE (PH)
 - NEW OR MODIFIED FACILITY

- NOTES:**
1. SOURCE: USGS 7.5 MINUTE QUADRANGLE MAPS (PROJECTION: STATE PLANE NAD83 CALIFORNIA ZONE I IN FEET)
 2. UNFFR: UPPER NORTH FORK FEATHER RIVER
- SCALE (MILES)
-
-



⑦ CONSTRUCT WATER CHILLER NEAR POE DAM

⑤ INCREASE ROCK CREEK DAM RELEASE TO 600 CFS

⑥ INCREASE GRIZZLY CREEK RELEASE TO 100 CFS

④ CONSTRUCT BYPASS PIPELINE TO CONVEY WARM WATER FROM EBNFFR INTO UPPER ROCK CREEK RESERVOIR

③ OPERATE CARIBOU PHs IN STRICT PEAKING MODE WITH SEVERAL HOURS SHUTDOWN

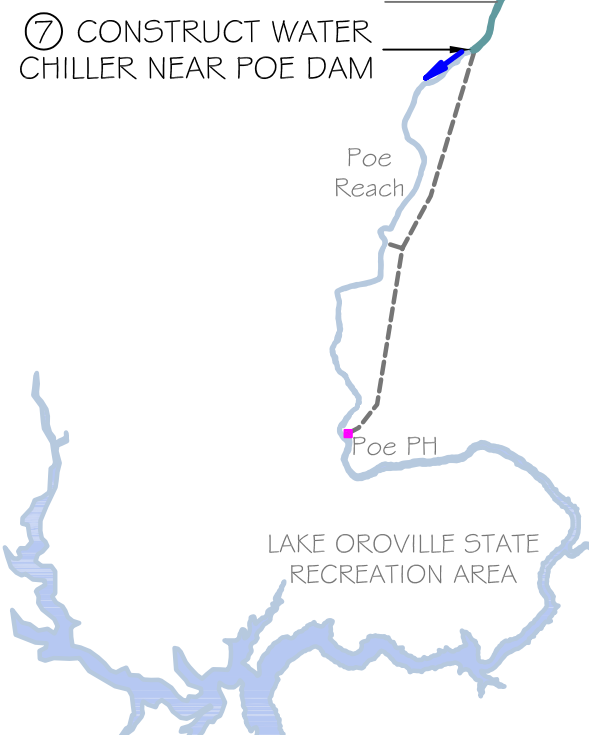
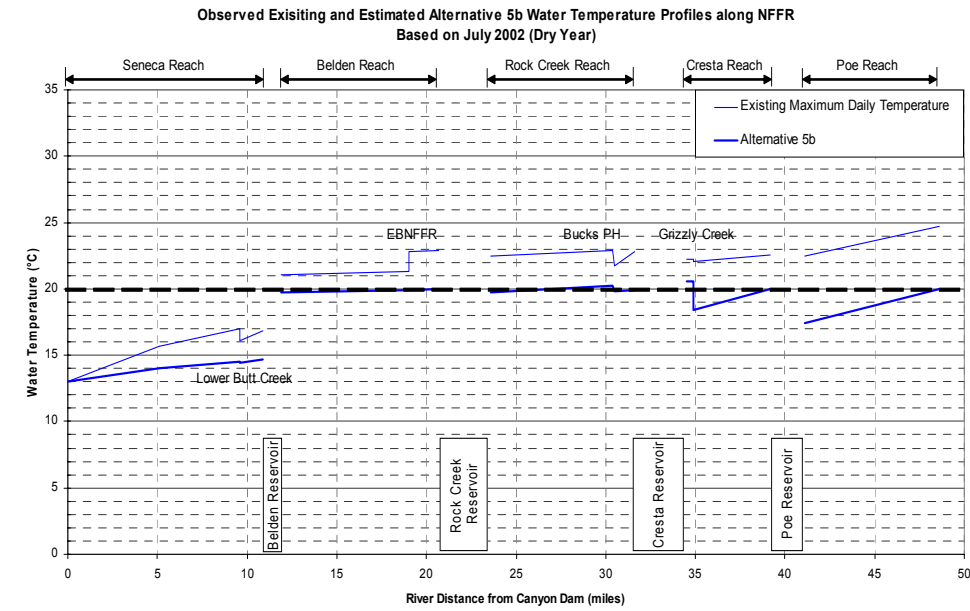
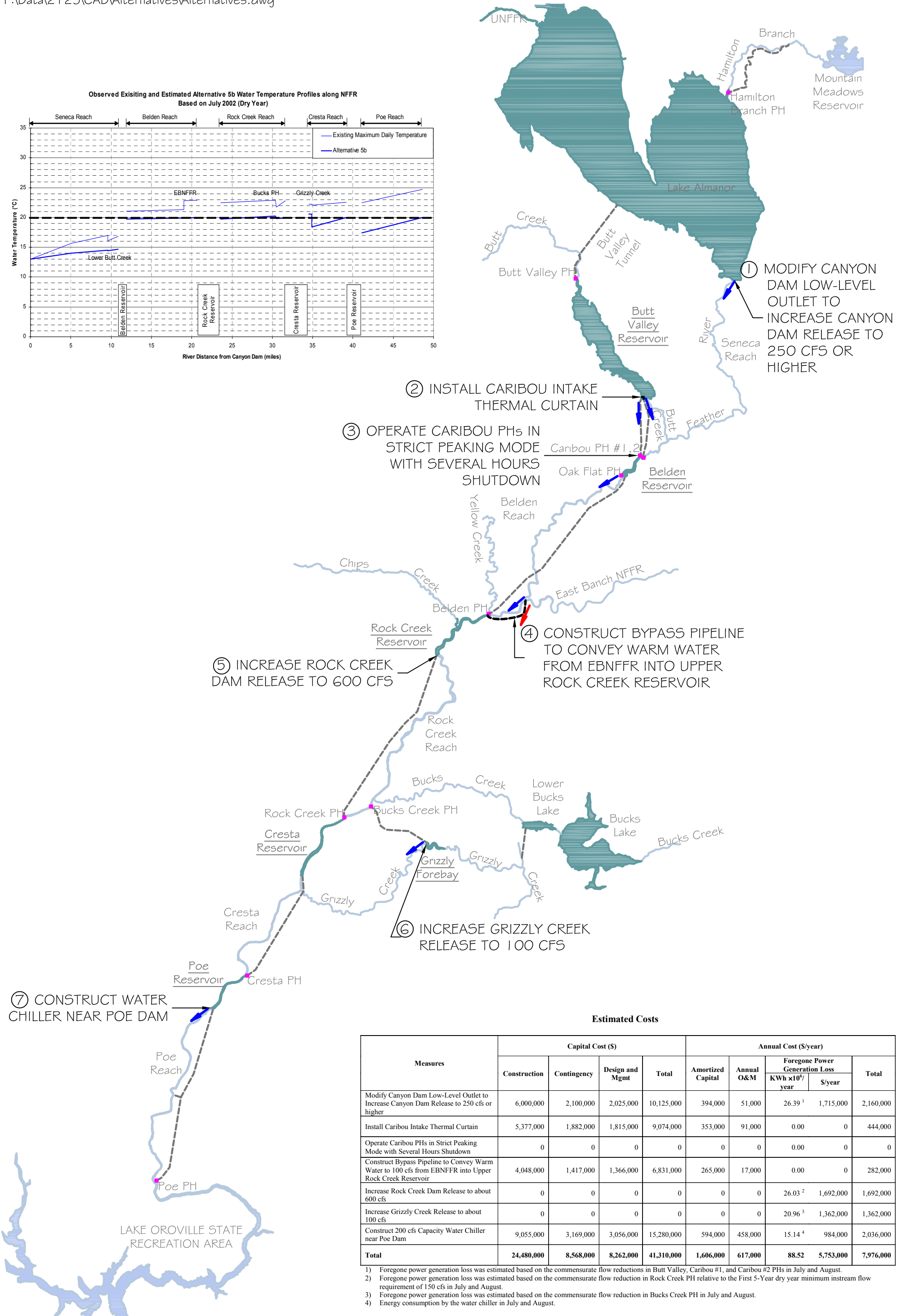
② OPERATE CARIBOU #1 PH PREFERENTIALLY

① MODIFY CANYON DAM LOW-LEVEL OUTLET TO INCREASE CANYON DAM RELEASE TO 250 CFS OR HIGHER

Estimated Costs

Measures	Capital Cost (\$)				Annual Cost (\$/year)				
	Construction	Contingency	Design and Mgmt	Total	Amortized Capital	Annual O&M	Foregone Power Generation Loss		Total
							KWh x10 ⁶ /year	\$/year	
Modify Canyon Dam Low-Level Outlet to Increase Canyon Dam Release to 250 cfs or higher	6,000,000	2,100,000	2,025,000	10,125,000	394,000	51,000	26.39 ¹	1,715,000	2,160,000
Operate Caribou #1 PH Preferentially	0	0	0	0	0	0	14.31 ²	930,000	930,000
Operate Caribou PHs in Strict Peaking Mode with Several Hours Shutdown	0	0	0	0	0	0	0.00	0	0
Construct Bypass Pipeline to Convey Warm Water to 100 cfs from EBNFFR into Upper Rock Creek Reservoir	4,048,000	1,417,000	1,366,000	6,831,000	265,000	17,000	0.00	0	282,000
Increase Rock Creek Dam Release to about 600 cfs	0	0	0	0	0	0	26.03 ³	1,692,000	1,692,000
Increase Grizzly Creek Release to about 100 cfs	0	0	0	0	0	0	20.96 ⁴	1,362,000	1,362,000
Construct 200 cfs Capacity Water Chiller near Poe Dam	9,055,000	3,169,000	3,056,000	15,280,000	594,000	458,000	15.14 ⁵	984,000	2,036,000
Total	19,103,000	6,686,000	6,447,000	32,236,000	1,253,000	526,000	102.83	6,683,000	8,462,000

1) Foregone power generation loss was estimated based on the commensurate flow reductions in Butt Valley, Caribou #1, and Caribou #2 PHs in July and August.
 2) Foregone power generation loss due to lower turbine efficiency of Caribou #1 PH relative to Caribou #2 PH (by about 15%).
 3) Foregone power generation loss was estimated based on the commensurate flow reduction in Rock Creek PH relative to the First 5-Year dry year minimum instream flow requirement of 150 cfs in July and August.
 4) Foregone power generation loss was estimated based on the commensurate flow reduction in Bucks Creek PH in July and August.
 5) Energy consumption by the water chiller in July and August.



Estimated Costs

Measures	Capital Cost (\$)				Annual Cost (\$/year)				
	Construction	Contingency	Design and Mgmt	Total	Amortized Capital	Annual O&M	Foregone Power Generation Loss		Total
							KWh x10 ⁶ /year	\$/year	
Modify Canyon Dam Low-Level Outlet to Increase Canyon Dam Release to 250 cfs or higher	6,000,000	2,100,000	2,025,000	10,125,000	394,000	51,000	26.39 ¹	1,715,000	2,160,000
Install Caribou Intake Thermal Curtain	5,377,000	1,882,000	1,815,000	9,074,000	353,000	91,000	0.00	0	444,000
Operate Caribou PHs in Strict Peaking Mode with Several Hours Shutdown	0	0	0	0	0	0	0.00	0	0
Construct Bypass Pipeline to Convey Warm Water to 100 cfs from EBNFFR into Upper Rock Creek Reservoir	4,048,000	1,417,000	1,366,000	6,831,000	265,000	17,000	0.00	0	282,000
Increase Rock Creek Dam Release to about 600 cfs	0	0	0	0	0	0	26.03 ²	1,692,000	1,692,000
Increase Grizzly Creek Release to about 100 cfs	0	0	0	0	0	0	20.96 ³	1,362,000	1,362,000
Construct 200 cfs Capacity Water Chiller near Poe Dam	9,055,000	3,169,000	3,056,000	15,280,000	594,000	458,000	15.14 ⁴	984,000	2,036,000
Total	24,480,000	8,568,000	8,262,000	41,310,000	1,606,000	617,000	88.52	5,753,000	7,976,000

1) Foregone power generation loss was estimated based on the commensurate flow reductions in Butte Valley, Caribou #1, and Caribou #2 PHs in July and August.
 2) Foregone power generation loss was estimated based on the commensurate flow reduction in Rock Creek PH relative to the First 5-Year dry year minimum instream flow requirement of 150 cfs in July and August.
 3) Foregone power generation loss was estimated based on the commensurate flow reduction in Bucks Creek PH in July and August.
 4) Energy consumption by the water chiller in July and August.

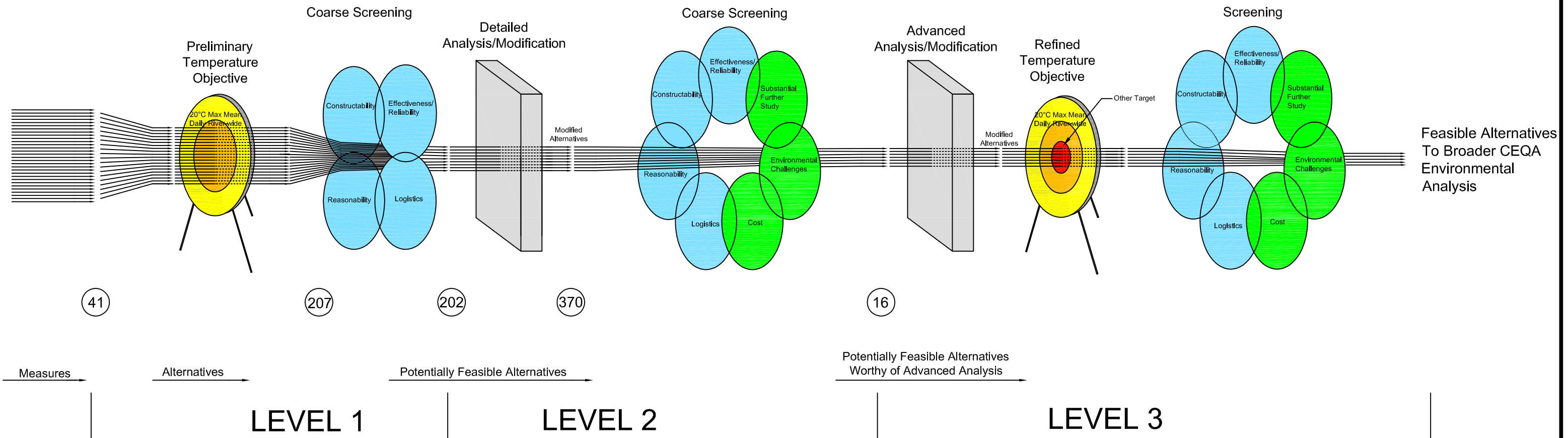


Figure 5-8

Upper North Fork Feather River: Alternatives Development and Evaluation Process Flow Diagram and Resulting Number of Alternatives in Level 1 & 2

6.0 PROPOSED APPROACH FOR LEVEL 3 ANALYSIS OF WATER TEMPERATURE REDUCTION ALTERNATIVES

This chapter describes the proposed approach for Level 3 analysis and further screening of water temperature reduction alternatives that pass Level 2 (as summarized in Table 5-4 of Chapter 5). The 16 resulting water temperature reduction alternatives that pass Level 2 represent *the set of potentially effective and feasible* alternatives to achieving the temperature target. These water temperature reduction alternatives were formulated using the results of existing modeling studies conducted primarily by PG&E with some enhancements by Stetson. The purpose of Level 3 analysis will be to verify the effectiveness, sustainability, and long-term reliability of those water temperature reduction alternatives that pass Level 2. The water temperature reduction alternatives that pass Level 2 will be analyzed through detailed modeling using newly developed and improved water quality models, to modify or refine the alternatives where necessary, and to screen the alternatives to arrive at a *set of effective and feasible* water temperature reduction alternatives that are suitable for broader environmental analysis in the EIR.

Following are the major steps in the proposed approach for the Level 3 analysis:

- Identify the feasible “UNFFR Project-only” water temperature reduction alternative and develop the associated water temperature profile along the NFFR;
- Verify the effectiveness, sustainability, and long-term reliability of the water temperature reduction alternatives that pass Level 2 through detailed modeling using newly developed and improved water quality models, and modify or refine the water temperature reduction alternatives as necessary to meet the temperature target;
- Prepare feasibility-level engineering designs and associated costs, including capital, O&M, and foregone energy replacement, for the water temperature reduction alternatives verified to be effective, sustainable, and reliable;
- Screen the water temperature reduction alternatives determined to be effective, sustainable, reliable, and feasible, and select those that are most suitable for CEQA analysis; and
- Prepare the Level 3 Report.

6.1 IDENTIFY THE FEASIBLE “UNFFR PROJECT-ONLY” WATER TEMPERATURE REDUCTION ALTERNATIVE AND DEVELOP THE ASSOCIATED WATER TEMPERATURE PROFILE ALONG THE NFFR

In deciding whether to issue 401 certification for the UNFFR Project, the State Water Board will consider feasible modifications to the UNFFR Project (i.e., the UNFFR Project-only alternative) to address controllable factors within project boundaries that are contributing to seasonal warming of the NFFR. Alternatives 2c and 3 in Table 5-4 of Chapter 5, excluding the measures outside the FERC Project 2105 boundary, are two examples of UNFFR Project-only water temperature reduction alternatives. The water temperature profile along the NFFR that is associated with such feasible modifications will define the temperature target for all the water temperature reduction alternatives. In Level 1 and 2, the temperature target used was 20°C

maximum mean daily water temperature along the NFFR. This target may be modified based on the results of Level 3 analysis of the UNFFR Project-only alternative.

Detailed modeling using the newly developed and improved water quality models will be carried out to determine the water temperature profile along the NFFR that is associated with the UNFFR Project-only alternative. The modeling work will consider the following flow releases as baseline conditions:

- Canyon Dam releases to the Seneca Reach are those agreed to in the Partial Settlement for the UNFFR Project except flows used for the measures of “increased Canyon Dam releases”;
- Belden Dam releases to the Belden Reach are those given in the Partial Settlement for the UNFFR Project;
- Rock Creek Dam releases to the Rock Creek Reach are those given in the 2000 Relicensing Settlement Agreement for the Rock Creek-Cresta Project;
- Cresta Dam releases to the Cresta Reach are those given in the 2000 Relicensing Settlement Agreement for the Rock Creek-Cresta Project; and,
- Poe Dam releases to the Poe Reach are those given in the USFS’s final 4(e) conditions for the Poe Project.

6.2 VERIFY THE EFFECTIVENESS, SUSTAINABILITY, AND LONG-TERM RELIABILITY OF WATER TEMPERATURE REDUCTION ALTERNATIVES THAT PASS LEVEL 2 THROUGH DETAILED MODELING USING NEWLY DEVELOPED AND IMPROVED WATER QUALITY MODELS, AND MODIFY OR REFINE THE WATER TEMPERATURE REDUCTION ALTERNATIVES AS NECESSARY TO MEET THE TEMPERATURE TARGET

Level 3 analysis is needed to verify the effectiveness, sustainability, and reliability for the water temperature reduction alternatives that pass Level 2 in meeting the NFFR temperature target. The water temperature reduction alternatives that pass Level 2 were formulated using the results of existing modeling studies conducted primarily by PG&E with some enhancements by Stetson. The effectiveness, sustainability, and long-term reliability of these alternatives have not been verified. For example, Alternative 3 in Table 5-4 shows that three measures are needed to reduce Belden Reservoir water temperature to 16.0°C plus one additional measure is needed for each of the Belden and Cresta Reaches, and two additional measures are needed for the Poe Reach to meet the temperature target for the river. More detailed modeling studies using long-term hydrology and meteorology data are needed to verify whether the three measures can indeed effectively, sustainably, and reliably reduce the Belden Reservoir water temperature to 16.0°C. If not, the measure of increasing Canyon Dam low-level outlet release to 250 cfs could be modified to allow a higher release rate and/or the measures for the Cresta Dam and Poe Dam/Poe Adit releases could be refined. Conversely, if modeling studies show that the three measures can reduce Belden Reservoir water temperature to less than 16.0°C, the measures for the Cresta Dam and Poe Dam/Poe Adit releases could also be refined.

Table 6-1 summarizes all models that will be used in Level 3 to analyze water temperature profiles along the NFFR, and Figure 6-1 shows how these models are related. For example, outflow and temperature at Canyon Dam derived from output of the Lake Almanor model will be

input to the Seneca Reach SNTMP model. Outflow and temperature at the Butt Valley PH derived from output of the Lake Almanor model will be input to the Butt Valley Reservoir CE-QUAL-W2 model. The outflows and temperatures at the Caribou #1 and #2 PHs derived from output of the Butt Valley Reservoir CE-QUAL-W2 model, and outflow and temperature derived from output of the Seneca Reach SNTMP model will be either fully mixed at Belden Reservoir or input to the Belden Reservoir CE-QUAL-W2 model, depending on the water temperature reduction alternatives for evaluation²⁹. Outflow and temperature at the Belden PH derived from output of the Belden Reservoir model will define the discharge water temperature at the Belden PH and will be input to the Rock Creek Reservoir SNTMP model. Outflow and temperature at the Belden Dam derived from output of the Belden Reservoir model will be input to the Belden Reach SNTMP model. Water temperature profiles along the Rock Creek, Cresta, and Poe Reaches will be computed using SNTMP models for these reaches. Water temperature calculations for Cresta and Poe Reservoirs will be conducted using the complete mixing method of analysis³⁰ which will be performed outside of the modeling work.

In PG&E's modeling studies for the historical 33 years (1970 – 2002), Rock Creek Reservoir was assumed to be completely mixed and warming in the reservoir was not accounted for. However, about 0.5°C – 1.0°C warming from the upstream to downstream of Rock Creek Reservoir was observed during the July 2003 Caribou special test and again during the 2006 special test. Not accounting for the warming would underestimate water temperatures in the Rock Creek Reach and downstream reaches. A new Rock Creek Reservoir SNTMP model currently being constructed by Stetson from a previous model developed by PG&E³¹ will be used to account for warming through the reservoir. Rock Creek Reservoir is relatively long, shallow, narrow, and similar, in terms of thermal behavior, to a river. The previous Rock Creek Reservoir SNTMP model has been well calibrated by PG&E using the July 2003 Caribou special test data.

It is worth noting that two models for Lake Almanor are included in Table 6-1 and Figure 6-1. The existing Lake Almanor MITEMP model was developed by Bechtel for simulating Lake Almanor water temperature profiles and discharge water temperatures at Butt Valley PH and Canyon Dam. The Lake Almanor CE-QUAL-W2 model was initially developed by Jones & Stokes, and recently improved by Stetson, for simulating the impacts of cold water withdrawal on the distribution of appropriate temperature and dissolved oxygen concentrations, providing suitable cold freshwater habitat in the lake. The two models may need to be used conjunctively for Lake Almanor water temperature simulations since both models have unique limitations in

²⁹ For the Alternatives 2c, 3, 4a, 4b, and 4c in Table 5-4 of Chapter 5, stratification in Belden Reservoir, if any, is expected to be weak because all inflow sources to Belden Reservoir are cool and water temperature differences between the sources are small. So, Belden Dam release and Belden PH discharge water temperatures can be determined using the complete mixing method by mixing all inflows and inflow temperatures to Belden Reservoir. For the Alternatives 5a and 5b in Table 5-4, stratification in Belden Reservoir is expected. The Belden Reservoir CE-QUAL-W2 model will be used to evaluate the sustainability of routing cold water through the stratified reservoir by balancing inflows relative to outflows.

³⁰ Historical observations show that water temperatures in the Cresta and Poe Reservoirs are generally well mixed.

³¹ The new Rock Creek Reservoir SNTMP model was originally developed by PG&E as an extension to the existing Belden Reach SNTMP model which used meteorological data at the Prattville Intake station. Stetson will separate the Rock Creek Reservoir SNTMP model from the Belden Reach SNTMP model because Rock Creek Reservoir and Belden Reach are two different water bodies and it makes more sense for the Rock Creek Reservoir SNTMP model to use meteorological data at the Rock Creek Dam station, rather than the Prattville Intake station. Stetson will also test the new Rock Creek Reservoir SNTMP model using the 2006 special testing data.

simulating the withdrawal water temperatures at the Prattville Intake³². The most significant limitation of the Lake Almanor MITEMP model is that a minimum outflow of 700 cfs was prescribed in the model code for discharges at the Butt Valley PH and Canyon Dam. Specifically, the model automatically uses 700 cfs to compute withdrawal water temperatures, even if discharges are less than 700 cfs. The model code was modified and recompiled by Bechtel to remove this minimum flow setting at the request of Stetson in April 2006. However, the reliability of the so-modified Lake Almanor MITEMP model has not been verified, particularly at low discharges that are less than 700 cfs. The modified MITEMP model will be verified by running the model for the calibration year 2000 and for the special testing year 2006, then comparing the model output with observed data. This testing will verify the reliability of the modified MITEMP model at low discharge conditions because both years had a period with flow discharges at the Prattville Intake less than 700 cfs. The Lake Almanor MITEMP and CE-QUAL-W2 models will be used conjunctively based on the outcome of the testing.

A comprehensive work plan for Level 3 water temperature reduction alternative analysis will be prepared prior to conducting detailed water temperature modeling. The Level 3 process will be consistent with that described for screening of Level 1 and 2, but will include more rigorous modeling, design work, and analysis. The modeling approach, model simulation scenarios, approach in determining an appropriate long-term modeling analysis period, approach in synthesizing long-term hydrological and meteorological data for model inputs, and approach in determining typical “normal”, “warm”, and “cool” weather conditions will be described in the comprehensive work plan.

6.3 PREPARE FEASIBILITY-LEVEL ENGINEERING DESIGNS AND ASSOCIATED COSTS, INCLUDING CAPITAL, O&M, AND FOREGONE ENERGY REPLACEMENT, FOR THE WATER TEMPERATURE REDUCTION ALTERNATIVES VERIFIED TO BE EFFECTIVE, SUSTAINABLE, AND RELIABLE.

Feasibility-level engineering designs and cost estimates, including capital, O&M, and foregone energy replacement, for the water temperature reduction alternatives verified to be effective, sustainable, and reliable will be prepared. The design layouts and cost estimate results of Level 3 will be presented in a format similar to Level 2.

6.4 SCREEN WATER TEMPERATURE REDUCTION ALTERNATIVES DETERMINED TO BE EFFECTIVE, SUSTAINABLE, RELIABLE, AND SELECT ALTERNATIVES TO BE CARRIED FORWARD FOR CEQA ANALYSIS.

The water temperatures reduction alternatives that are verified to be effective, sustainable, and reliable will become initial Level 3 water temperature reduction alternatives. These initial Level 3 water temperature reduction alternatives will be screened based on the similar screening criteria used in Level 2, although the economic criterion may be refined by the State Water Board. The resulting set of water temperature reduction alternatives passing the Level 3 screening will represent *the set of effective and feasible alternatives*. These water temperature reduction alternatives will be carried forward into the EIR where they will be augmented and/or

³² The Lake Almanor CE-QUAL-W2 model is not reliable for simulating the hydraulic effects of removing the submerged levees near the intake, while the Lake Almanor MITEMP model is not reliable for simulating discharge water temperatures at the Butt Valley PH at low discharges. Both conditions were included in the water temperature reduction alternatives that pass Level 2 and will need to be evaluated in Level 3.

modified to address potentially significant environmental impacts identified through the CEQA process.

6.5 PREPARE LEVEL 3 REPORT

A report documenting Level 3 analysis of water temperature reduction alternatives will be prepared upon completion of the above analyses and feasibility-level designs and costs. It is anticipated the Level 3 Report will include the following sections and appendices:

- Introduction
- Summary of Level 1 and 2 Analysis of Water Temperature Reduction Alternatives
- Analysis of Effectiveness, Sustainability, and Reliability of the Water Temperature Reduction Alternatives That Pass Level 2
- Initial Level 3 Water Temperature Reduction Alternatives Verified to Be Effective, Sustainable, and Reliable – Design Layouts, Operational Requirements, Cost Estimates, and Effectiveness
- Screening of Initial Level 3 Water Temperature Reduction Alternatives and Resulting Final Level 3 Water Temperature Reduction Alternatives
- Recommendation of Water Temperature Reduction Alternatives for CEQA Analysis
- Appendix A: Water Temperature Profiles along the NFFR for Water Temperature Reduction Alternatives Over a Range of Meteorological Conditions
- Appendix B: Feasibility-Level Engineering Designs and Cost Estimates for the Water Temperature Reduction Alternatives Verified to Be Effective, Sustainable, and Reliable
- Appendix C: Documentation of the Development of New and Improved Water Quality Models: Lake Almanor, Butt Valley Reservoir, and Belden Reservoir CE-QUAL-W2 Models

Table 6-1 Proposed NFFR Water Temperature Models for Level 3 Analysis

Models	Notes
Existing Lake Almanor MITEMP model	The Lake Almanor MITEMP model was developed by Bechtel in 2002. The model code was originally set at a minimum outflow of 700 cfs for discharges at Canyon Dam and the Butt Valley PH. The model code was modified and recompiled by Bechtel to remove this minimum flow setting at the request of Stetson in April 2006. The Lake Almanor MITEMP model simulates water temperature only.
Improved Lake Almanor CE-QUAL-W2 model	The Lake Almanor CE-QUAL-W2 model was developed by Jones & Stokes in 2004. The original model did not accurately capture the relationship between discharge rate (particularly at low discharge rates) and discharge water temperatures at the Butt Valley PH. The model was improved by Stetson to capture this relationship. The Lake Almanor CE-QUAL-W2 will be used to simulate water temperature and dissolved oxygen.
New Butt Valley Reservoir CE-QUAL-W2 model	The new CE-QUAL-W2 model was developed by Stetson. It will be used to simulate both water temperature and dissolved oxygen.
New Belden Reservoir CE-QUAL-W2 model	The new CE-QUAL-W2 model was developed by Stetson. It will be used to simulate water temperature.
Existing Seneca Reach SNTTEMP model	The existing Seneca Reach SNTTEMP model was developed by Thomas R. Payne and Associates (received from PG&E in July 2005). It will be used to simulate the water temperature profile along the Seneca Reach.
Existing Belden Reach SNTTEMP model	The existing Belden Reach SNTTEMP model was developed by Thomas R. Payne and Associates (received from PG&E in July 2005). It will be used to simulate the water temperature profile along the Belden Reach.
New Rock Creek Reservoir SNTTEMP model	The new Rock Creek Reservoir SNTTEMP model is being derived by Stetson from a previous model developed by PG&E. This model will be used to simulate warming from the upstream to downstream ends of Rock Creek Reservoir.
Existing Rock Creek Reach SNTTEMP model	The existing Rock Creek Reach SNTTEMP model was developed by Thomas R. Payne and Associates (received from PG&E in July 2005). It will be used to simulate the water temperature profile along the Rock Creek Reach.
Existing Cresta Reach SNTTEMP model	The existing Cresta Reach SNTTEMP model was developed by Thomas R. Payne and Associates (received from PG&E in July 2005). It will be used to simulate the water temperature profile along the Cresta Reach.
Existing Poe Reach SNTTEMP model	The existing Poe Reach SNTTEMP model was developed by PG&E. It will be used to simulate the water temperature profile along the Poe Reach (received from PG&E in July 2005).

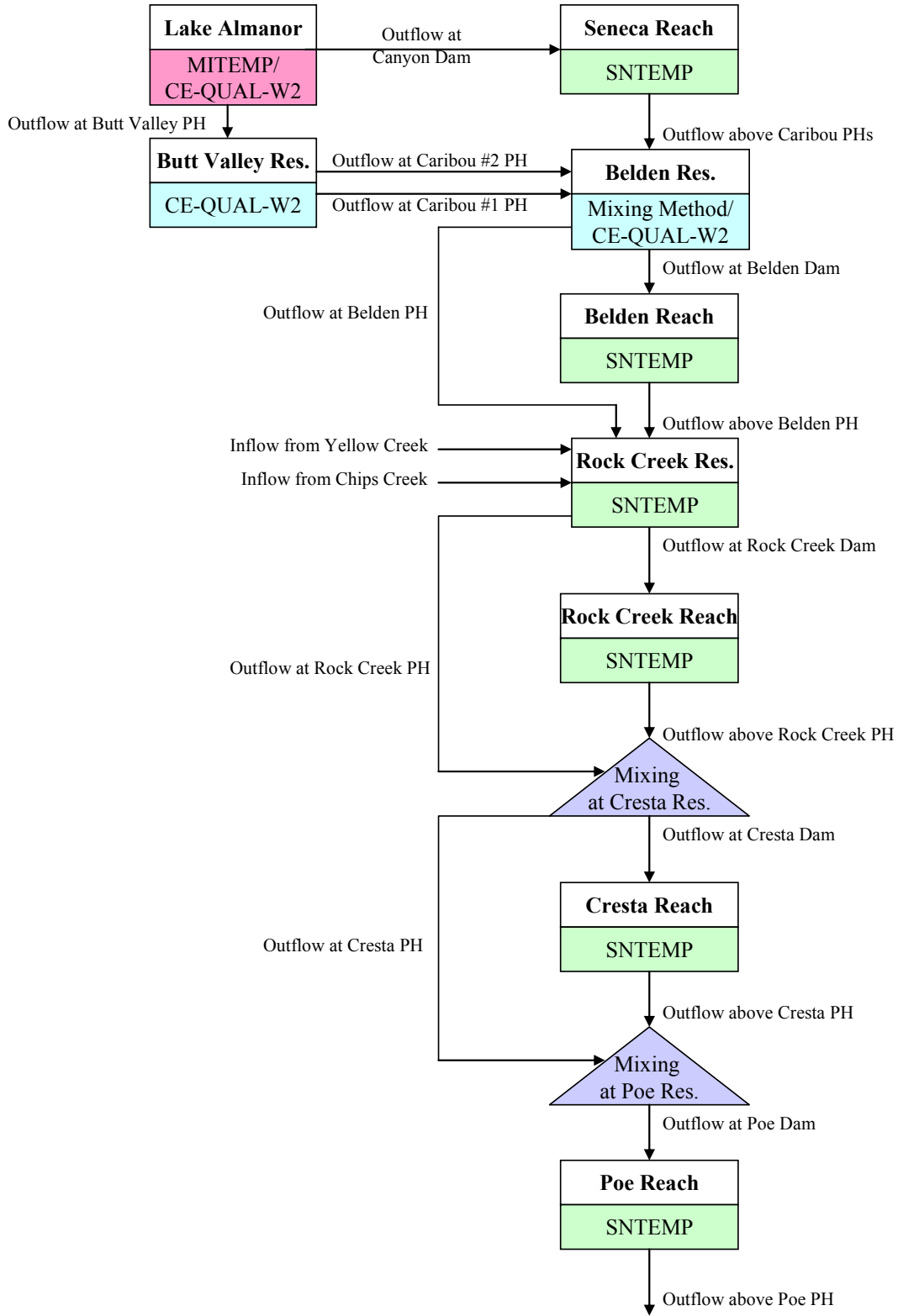


Figure 6-1 Proposed Water Temperature Models and Model Relationships

REFERENCES

- Bechtel Corporation and Thomas R. Payne and Associates, 2006. North Fork Feather River Instream Temperature Studies, 33 Years of Synthesized Reservoir Operations, Evaluation of Installation of Curtains and Modifications in Lake Almanor and Butt Valley Reservoir and High Instream Flow Releases from Canyon Dam.
- Black and Veatch, 2004a. Prattville Intake Modifications Phase 3 Feasibility Study, Final Report.
- Black and Veatch, 2004b. Prattville Intake Modifications Closeout Status Memorandum.
- Black and Veatch, 2005a. North Fork Feather River Yellow Creek Diversion Cooling Water Pipeline Feasibility Report.
- Black and Veatch, 2005b. Poe Tunnel Adit Feasibility Study/ Pre-Feasibility Level Sizing and Cost Estimate Summary Memorandum.
- Black and Veatch, 2007. Flow Improvement Modifications/ Plan & Sections/ Canyon Dam Intake Tower.
- California Regional Water Quality Control Board, Central Valley Region, 2004, amended 2006. Water Quality Control Plan for the Central Valley Region.
- FERC, 2001. FERC License No. 1962.
- FERC, 2005. Final Environmental Impact Statement, Upper North Fork Feather River Project, California.
- IIHR, 2003. Cold Water Feasibility Study, Prattville Intake, Lake Almanor, Hydraulic and Numerical Modeling, Final Report – under preparation.
- IIHR, the University of Iowa, 2004. Lake Almanor Cold-Water Feasibility Study: Hydraulic Model.
- PG&E, 2002. Upper North Fork Feather River Project, FERC Project No. 2105, Application for New License.
- PG&E, 2003. Water Temperature Monitoring of 2002, Rock Creek – Cresta Project, FERC Project No. 1962.
- PG&E, 2004. Results of 2003 Water Temperature Monitoring and Special Caribou Powerhouse Test, FERC License Condition No. 4C and License Condition No. 5, Rock Creek-Cresta Project, FERC Project No. 1962.

- PG&E, 2005a. Water Temperature Monitoring of 2004, Rock Creek – Cresta Project, FERC Project No. 1962.
- PG&E, 2005b. North Fork Feather River Study Data and Informational Report on Water Temperature Monitoring and Additional Reasonable Water Temperature Control Measures.
- PG&E, 2005c. Evaluation of Additional Alternative to Provide Cooler Water to the North Fork Feather River/ Pipe Yellow Creek Water Alternative.
- PG&E, 2005d. Evaluation of Additional Alternative to Provide Cooler Water to the North Fork Feather River/ Mechanical Water Chillers Alternative.
- PG&E, 2005e. Evaluation of Additional Alternative to Provide Cooler Water to the North Fork Feather River/ Mechanical Cooling Tower Alternative.
- Stetson and PG&E, 2007. 2006 North Fork Feather River Special Testing Data Report.
- Woodward-Clyde Consultants, 1986. Rock Creek – Cresta Project Cold Water Feasibility Study, Volume 1. Prepared for Pacific Gas and Electric Company.
- , 2000. Rock Creek - Cresta Relicensing Settlement Agreement.
- , 2004. Upper North Fork Feather Project, Project 2105 Relicensing Settlement Agreement.

Appendix A

Summary of Observed Summer 2002 - 2004 Mean Daily Water Temperatures and Flows along NFFR

Table A-1
Summary of Observed Summer Mean Daily Water Temperatures (°C) along NFFR

Station	Month	2002			2003			2004		
		max	min	mean	max	min	mean	max	min	mean
NFFR at Chester (NF1)	June	15.4	9.6	12.7	12.9	10.0	11.3	13.7	8.3	11.8
	July	16.8	14.7	15.7	16.5	11.8	14.4	16.0	13.0	14.7
	Aug	16.1	12.8	14.2	15.1	12.6	13.4	15.1	12.7	13.9
	Sept	14.0	9.8	11.5	14.0	9.8	11.6	13.0	8.3	11.1
Hamilton Branch at Road bridge (HB1)	June	12.4	10.1	11.8	15.3	10.0	12.2	12.4	9.7	11.7
	July	12.6	11.5	12.0	12.4	10.8	11.5	12.7	11.5	12.2
	Aug	12.7	11.0	11.8	12.0	10.9	11.5	12.2	10.8	11.5
	Sept	11.7	9.3	10.4	11.4	9.4	10.3	12.0	8.4	10.3
Hamilton Branch Powerhouse (HB2)	June	13.4	10.9	12.6	21.1	11.6	15.3	15.8	12.0	13.9
	July	14.0	12.4	13.3	16.6	11.8	13.1	14.6	13.2	13.8
	Aug	19.1	16.1	17.5	19.2	15.2	18.0	16.7	12.3	15.7
	Sept	17.0	9.5	14.4	18.6	9.1	15.4	16.7	12.6	14.9
Lake Almanor at Canyon Dam near surface (LA1-S)	June	22.5	16.9	19.7	---	---	---	21.6	17.2	19.6
	July	25.3	21.7	23.6	26.3	24.7	25.3	24.3	21.3	22.8
	Aug	25.4	21.8	23.1	24.8	21.5	22.4	23.7	21.3	22.5
	Sept	22.5	18.1	20.0	22.4	18.4	20.0	21.0	17.6	19.2
Lake Almanor at Canyon Dam near bottom (LA1-B)	June	9.3	8.2	8.9	---	---	---	14.7	13.0	13.9
	July	10.4	9.3	9.9	9.9	9.8	9.9	14.9	10.5	13.4
	Aug	11.2	10.5	10.8	10.7	9.9	10.2	11.3	10.7	11.0
	Sept	11.4	11.1	11.3	10.9	10.6	10.8	11.1	9.8	10.0
NFFR below Canyon Dam (NF2)	June	11.9	10.6	11.3	10.8	9.8	10.4	19.9	15.7	17.8
	July	13.0	11.8	12.5	11.9	10.8	11.5	22.5	19.9	21.1
	Aug	13.4	12.9	13.3	12.4	11.9	12.2	22.1	20.2	21.2
	Sept	14.1	13.3	13.7	12.9	12.3	12.6	20.0	17.0	18.4
NFFR at Seneca Bridge (NF3)	June	14.7	11.8	13.5	13.9	11.2	13.0	17.7	13.4	16.0
	July	15.7	14.2	15.0	15.5	12.7	14.2	19.9	17.3	18.6
	Aug	15.6	13.5	14.5	14.4	13.1	13.7	19.2	17.0	18.2
	Sept	14.6	12.2	13.4	14.0	11.7	12.8	17.3	13.4	15.5
NFFR above Caribou PH (NF4)	June	15.6	12.3	14.3	14.9	11.8	13.9	16.4	12.3	15.0
	July	16.8	15.0	15.9	16.8	13.5	15.2	18.1	16.0	17.1
	Aug	16.3	13.9	15.0	15.6	13.6	14.4	17.6	15.4	16.6
	Sept	15.0	12.1	13.4	14.8	11.8	13.1	16.0	12.2	14.2
Butt Valley Powerhouse [Corrected] (BV1)	June	16.1	14.8	15.5	16.3	11.7	14.1	18.7	14.7	17.4
	July	21.7	17.8	20.2	19.1	15.4	17.4	21.3	18.4	19.7
	Aug	21.9	20.4	21.2	20.4	19.3	19.8	21.8	20.2	21.1
	Sept	21.3	17.9	19.3	20.6	17.8	18.9	20.3	16.8	18.6

Note:

- 1) All values are mean daily water temperatures computed from hourly temperature measurements. Monthly statistics represent the maximum, minimum, and mean daily water temperatures based on the hourly temperature measurements. For example, the maximum June temperature represents the maximum mean daily temperature measured in June.
- 2) Refer to Figure 2-1 for station locations.

Table A-1
Summary of Observed Summer Mean Daily Water Temperatures (°C) along NFFR
(Continued)

Station	Month	2002			2003			2004		
		max	min	mean	max	min	mean	max	min	mean
Butt Valley Res. at Caribou Intake Near surface (BV2-S)	June	22.1	18.3	20.1	22.7	18.3	20.2	21.8	18.4	20.1
	July	24.4	22.1	23.3	24.6	19.0	21.7	23.9	21.7	22.6
	Aug	24.0	21.7	22.7	22.5	21.0	21.6	23.1	21.5	22.4
	Sept	22.2	18.4	20.1	22.0	18.4	19.9	21.5	17.4	19.5
Butt Valley Res. at Caribou Intake Near bottom (BV2-B)	June	11.9	9.4	10.4	11.9	9.6	10.8	17.5	12.0	14.7
	July	18.5	11.9	15.0	16.1	12.1	13.8	20.7	17.4	19.3
	Aug	20.8	18.7	20.0	18.9	16.4	18.2	21.5	20.7	21.1
	Sept	20.6	18.2	19.3	19.1	17.5	18.2	20.7	17.2	19.0
Butt Creek above Butt Valley Reservoir (BC1)	June	15.1	11.6	13.9	15.2	11.2	13.5	14.4	10.2	13.2
	July	16.0	13.7	14.7	16.2	13.0	14.5	15.2	12.9	14.0
	Aug	14.8	11.9	13.1	14.6	12.0	12.9	13.8	11.9	12.8
	Sept	13.1	9.5	11.1	12.9	9.8	11.1	12.0	8.8	10.7
Butt Creek below Butt Valley Reservoir (BC2)	June	10.7	10.4	10.6	10.9	10.5	10.7	10.7	10.4	10.6
	July	10.8	10.6	10.7	11.0	10.6	10.8	10.8	10.6	10.7
	Aug	10.8	10.5	10.7	10.9	10.6	10.7	10.8	10.6	10.7
	Sept	10.7	10.4	10.5	10.8	10.4	10.6	10.6	10.3	10.5
Butt Creek at Mouth (BC3)	June	12.1	10.6	11.5	12.2	10.8	11.8	12.2	10.5	11.7
	July	12.8	11.9	12.4	13.1	11.5	12.3	12.9	12.0	12.5
	Aug	12.9	11.7	12.4	12.6	11.9	12.3	13.1	12.2	12.7
	Sept	12.6	11.3	12.0	12.7	11.3	12.1	12.6	11.2	12.1
Caribou No. 1 Powerhouse [corrected] (CARB1)	June	13.3	12.3	12.7	11.2	10.9	11.0	18.0	16.4	17.2
	July	21.0	16.3	19.3	19.1	16.4	18.1	21.1	18.0	19.9
	Aug	21.9	21.2	21.4	20.0	17.5	19.5	21.7	20.8	21.2
	Sept	21.3	18.2	19.7	20.1	18.0	19.1	20.8	16.8	19.1
Caribou No. 2 Powerhouse [corrected] (CARB2A)	June	21.5	17.4	19.3	19.3	16.7	18.2	21.0	17.7	19.6
	July	24.0	21.9	23.2	23.4	18.4	20.4	22.7	21.0	22.0
	Aug	23.7	21.5	22.5	21.9	21.0	21.4	22.7	21.4	22.1
	Sept	22.1	18.3	19.9	21.8	19.2	20.2	21.4	17.4	19.4
Belden Reservoir At Intake (BD1)	June	21.5	18.1	19.5	19.3	15.8	18.1	20.0	15.8	17.8
	July	22.8	19.3	21.5	21.7	17.3	19.3	21.9	19.4	20.8
	Aug	22.6	21.4	21.9	21.1	20.3	20.7	22.2	21.1	21.7
	Sept	21.7	18.4	19.8	21.0	18.2	19.4	21.1	17.3	19.1
NFFR below Belden Dam (NF5)	June	18.9	15.9	17.4	18.2	14.1	16.8	19.1	15.2	17.0
	July	21.1	17.8	19.4	20.8	17.1	18.5	21.6	18.7	20.3
	Aug	21.2	20.2	20.7	20.5	18.4	19.8	21.8	20.8	21.4
	Sept	20.9	16.8	18.8	20.5	17.6	19.0	20.8	17.1	18.8

Table A-1
Summary of Observed Summer Mean Daily Water Temperatures (°C) along NFFR
(Continued)

Station	Month	2002			2003			2004		
		max	min	mean	max	min	mean	max	min	mean
Mosquito Creek At mouth (MC1)	June	14.4	11.4	13.0	---	---	---	13.8	10.6	12.6
	July	15.6	13.8	14.7	---	---	---	15.1	13.2	14.3
	Aug	15.3	12.9	13.9	15.0	12.8	13.5	14.5	13.2	13.8
	Sept	13.7	11.3	12.2	14.0	11.0	12.2	13.2	10.4	11.9
NFFR near Queen Lily Campground (NF6)	June	19.0	15.7	17.1	17.9	14.3	16.6	18.8	15.1	16.9
	July	21.1	18.1	19.5	20.6	17.3	18.5	21.2	18.5	20.0
	Aug	21.1	19.6	20.3	20.3	18.0	19.3	21.4	20.2	20.8
	Sept	20.9	19.3	18.0	19.9	16.7	17.9	20.2	16.1	17.7
NFFR near Gansner Bar (NF7)	June	19.3	16.2	17.5	18.4	14.9	16.9	19.0	14.7	17.1
	July	21.3	18.5	19.7	20.9	17.3	18.9	21.2	18.5	20.0
	Aug	21.1	19.1	20.1	20.5	17.9	19.3	21.3	19.9	20.5
	Sept	20.5	16.1	17.6	20.0	16.3	17.6	19.9	15.4	17.4
East Branch NFFR at mouth (EB1)	June	22.3	17.8	20.8	21.7	16.7	19.4	22.3	15.9	19.9
	July	25.5	22.4	23.8	26.4	20.1	23.1	24.8	21.1	23.0
	Aug	24.3	19.9	21.8	24.0	20.1	21.4	23.1	20.4	21.7
	Sept	21.6	15.9	18.2	21.3	16.4	18.3	20.6	14.6	17.7
NFFR at Belden Town Bridge (NF8)	June	21.2	17.1	19.4	20.5	16.5	18.7	20.8	15.5	18.9
	July	22.9	20.4	21.4	22.9	18.8	21.0	22.9	20.2	21.5
	Aug	22.3	19.5	20.7	22.0	19.2	20.4	22.0	20.1	21.0
	Sept	21.0	16.1	18.0	21.1	16.4	18.2	20.2	15.1	17.6
Belden Powerhouse (BD2)	June	18.7	17.7	18.0	19.2	15.6	18.1	20.0	16.6	18.8
	July	22.5	19.0	21.2	21.7	17.4	19.3	22.0	19.4	20.9
	Aug	22.6	21.4	21.8	21.1	20.3	20.7	22.2	21.1	21.7
	Sept	21.7	18.3	19.8	21.1	18.2	19.5	21.1	17.3	19.2
Yellow Creek Near mouth (YC1)	June	17.0	12.3	15.0	15.7	11.6	14.0	15.6	10.7	14.1
	July	18.6	16.0	17.1	18.9	13.8	16.3	17.2	14.7	16.0
	Aug	17.7	14.0	15.6	17.5	13.9	15.1	16.2	14.5	15.3
	Sept	15.4	11.8	13.1	15.3	11.5	13.0	14.4	10.6	12.6
Chips Creek Near mouth (CHIP)	June	16.2	10.6	13.6	14.4	9.0	11.5	14.4	9.4	12.5
	July	17.9	15.4	16.8	18.1	12.8	15.6	17.0	14.3	15.7
	Aug	17.7	14.5	15.9	17.2	14.2	15.2	16.5	14.7	15.5
	Sept	15.9	12.1	13.7	15.8	12.1	13.6	14.8	10.9	13.0
NFFR below Rock Creek Dam (NF9)	June	---	---	---	19.1	14.7	17.4	19.9	14.0	17.7
	July	---	---	---	22.0	18.0	19.8	21.9	19.4	20.9
	Aug	---	---	---	21.4	19.8	20.3	21.9	20.7	21.3
	Sept	---	---	---	20.6	17.3	18.8	20.6	16.7	18.5
NFFR at NF-57 Insitu Recorder (NF10)	June	20.7	20.1	20.3	19.1	14.9	17.6	19.9	14.1	17.7
	July	22.5	20.0	21.3	22.1	18.1	19.9	21.9	19.5	20.9
	Aug	22.1	20.5	21.2	21.6	19.9	20.4	21.9	20.6	21.3
	Sept	21.2	17.6	19.1	20.7	17.3	18.8	20.6	16.6	18.5

Table A-1
Summary of Observed Summer Mean Daily Water Temperatures (°C) along NFFR
(Continued)

Station	Month	2002			2003			2004		
		max	Min	mean	max	min	mean	max	min	mean
Milk Ranch Creek Near mouth (MR1)	June	16.0	10.6	14.0	15.8	11.0	13.4	15.7	9.7	13.6
	July	17.9	14.8	16.4	19.1	12.7	15.8	17.7	14.2	15.9
	Aug	17.2	13.3	15.0	17.3	13.4	14.9	16.4	14.0	15.2
	Sept	18.1	11.1	12.7	15.9	10.9	13.1	14.3	10.1	12.4
Chambers Creek Near mouth (CHAM)	June	16.5	9.0	13.7	15.7	9.7	12.6	16.0	9.3	13.2
	July	18.8	14.9	16.9	19.7	12.7	16.1	18.3	14.2	16.2
	Aug	18.1	13.9	15.7	17.7	14.2	15.3	17.1	14.2	15.8
	Sept	16.3	11.6	13.8	15.8	12.1	13.6	15.2	10.8	13.4
NFFR near Tobin Blw Granite Crk (NF11)	June	20.9	16.0	18.6	19.3	14.1	17.1	20.1	14.3	17.8
	July	22.8	20.2	21.5	22.6	17.9	20.2	22.2	19.7	21.1
	Aug	22.5	19.8	21.0	21.7	19.6	20.3	21.9	20.3	21.1
	Sept	21.0	17.3	18.8	20.9	17.0	18.6	20.4	16.3	18.3
Jackass Creek Near mouth (JC1)	June	16.5	9.6	14.1	16.9	11.4	14.1	16.5	10.6	14.2
	July	18.9	15.0	17.0	20.3	13.0	16.6	18.7	14.8	16.7
	Aug	18.3	13.7	15.9	18.4	14.3	16.1	17.6	14.8	16.3
	Sept	16.5	12.2	14.2	17.8	12.7	14.8	15.8	11.6	14.0
NFFR abv Bucks Creek (NF12)	June	21.0	15.9	18.6	19.3	14.2	17.2	20.2	14.4	17.9
	July	22.9	20.2	21.6	22.7	17.8	20.3	22.3	19.8	21.2
	Aug	22.6	19.7	21.0	21.8	19.6	20.3	22.0	20.4	21.2
	Sept	21.1	17.2	18.8	21.0	16.8	18.6	20.5	16.3	18.3
Bucks Creek Near Mouth (BUCK1)	June	18.1	12.4	16.0	17.1	12.3	15.2	17.7	11.1	15.5
	July	20.4	16.8	18.6	21.0	14.5	17.6	19.9	16.2	17.8
	Aug	19.3	14.8	16.9	18.8	15.0	16.5	18.2	15.6	16.8
	Sept	17.1	12.0	14.0	17.7	12.1	14.4	15.9	10.8	13.5
Bucks Creek Powerhouse (BUCK2)	June	18.6	13.2	15.6	13.5	10.5	12.4	13.4	11.3	12.4
	July	18.9	15.6	16.7	14.1	11.6	13.2	15.1	13.5	14.4
	Aug	15.5	13.5	14.3	15.7	11.9	13.5	13.4	12.4	12.8
	Sept	13.7	12.6	13.0	11.9	11.1	11.4	13.8	12.8	13.5
NFFR abv Rock Creek Powerhouse (NF13)	June	21.0	15.8	18.6	17.9	13.3	15.7	19.3	13.3	16.5
	July	22.8	19.4	20.7	23.0	15.4	18.7	21.1	18.6	19.5
	Aug	21.8	17.6	19.3	22.0	16.3	18.4	19.0	17.3	18.1
	Sept	18.1	15.0	16.3	17.1	14.2	15.6	19.2	15.7	17.2
Rock Creek Powerhouse (RC1)	June	20.1	16.1	18.1	19.6	14.8	17.7	20.1	14.3	17.8
	July	22.6	19.6	21.3	22.3	18.5	20.1	22.3	19.8	21.3
	Aug	22.6	21.0	21.7	22.0	20.4	20.9	22.5	21.4	21.9
	Sept	21.7	18.4	19.8	21.2	18.1	19.5	21.4	17.4	19.7

Table A-1
Summary of Observed Summer Mean Daily Water Temperatures (°C) along NFFR
(Continued)

Station	Month	2002			2003			2004		
		max	Min	mean	max	min	mean	max	min	mean
Rock Creek Near mouth (RC2)	June	17.6	11.4	14.8	16.4	9.5	12.8	17.4	10.0	14.3
	July	19.7	16.5	18.1	20.6	14.2	17.4	19.4	15.8	17.6
	Aug	19.3	15.6	17.1	22.0	16.3	18.4	18.1	16.1	17.2
	Sept	17.1	13.7	14.8	17.7	13.5	15.1	16.6	12.5	14.6
NFFR abv Grizzly Creek (NF14)	June	20.8	16.7	18.4	18.5	14.1	16.9	19.8	14.0	17.2
	July	22.2	20.3	21.2	22.2	17.4	19.6	21.6	19.4	20.7
	Aug	21.9	19.6	20.7	21.8	19.2	20.0	21.3	20.0	20.6
	Sept	20.5	17.1	18.5	20.1	16.8	18.2	20.0	16.5	18.3
Grizzly Creek Near mouth (GR1)	June	18.3	12.7	15.9	17.1	13.5	15.5	18.1	12.1	15.8
	July	20.8	17.8	19.3	21.2	15.1	18.2	20.3	17.3	18.8
	Aug	20.5	16.4	18.0	20.0	16.4	17.5	19.1	17.2	18.1
	Sept	17.8	13.5	15.0	18.4	13.4	15.3	17.2	12.1	14.7
NFFR at NF-56 blw Grizzly Crk (NF15)	June	20.9	16.2	18.4	18.6	14.0	16.9	19.7	14.3	17.3
	July	22.1	20.4	21.3	22.4	17.3	19.8	21.7	19.4	20.7
	Aug	22.0	19.5	20.6	21.9	19.3	20.0	21.3	19.9	20.6
	Sept	20.5	16.9	18.4	20.3	16.7	18.2	19.9	16.3	18.1
NFFR abv Cresta Powerhouse (NF16)	June	21.2	16.4	18.7	18.9	14.4	17.2	20.0	14.7	17.6
	July	22.6	20.9	21.7	22.7	17.7	20.1	22.1	19.7	21.1
	Aug	22.4	19.6	20.9	22.1	19.5	20.2	21.6	20.2	20.9
	Sept	20.7	17.1	18.5	20.6	16.5	18.3	20.2	16.5	18.3
Cresta Powerhouse (CR1)	June	20.8	16.3	18.5	18.5	13.9	16.8	19.8	13.8	17.1
	July	22.5	20.4	21.4	22.3	17.4	19.7	21.5	19.4	20.7
	Aug	22.5	20.1	21.0	22.0	19.5	20.2	21.2	20.1	20.7
	Sept	20.7	17.3	18.7	20.1	17.0	18.3	20.1	16.7	18.5
Middle Fork Feather River At Milsap Bar (MB1)	June	21.1	15.2	18.2	16.9	13.4	15.6	20.1	14.0	17.7
	July	23.3	20.5	21.9	23.4	19.0	21.4	22.5	19.9	21.0
	Aug	22.9	18.6	20.3	22.3	18.6	19.6	21.3	19.2	20.3
	Sept	19.9	16.2	17.3	20.0	16.6	18.0	19.2	13.7	16.5

Table A-2
Summary of Observed Summer Mean Daily Flows (cfs)

Station	Month	2002			2003			2004		
		max	min	mean	max	min	mean	max	min	mean
NFFR near Chester (NF1) [Temporary]	June	397	214	298	645	392	504	800	282	467
	July	212	139	175	373	206	273	346	143	196
	Aug	136	112	120	220	151	177	142	108	123
	Sept	111	97	104	152	121	135	132	103	110
Hamilton Branch at Road A13 Bridge (HB1) [Temporary]	June	85.5	69.7	76.8	267	89	124	111	74.0	83.2
	July	95.0	67.7	76.8	111	80	92	104	70.6	85.1
	Aug	78.0	75.8	76.5	96	69	76	101	68.5	93.3
	Sept	76.2	61.0	71.7	100	65	69	80.7	67.3	77.3
Hamilton Branch Powerhouse (NF-83)	June	38	32	34	197	35.3	77.1	78.8	27.7	56.9
	July	35	0	23	38.4	0.0	23.0	50.8	0.0	27.3
	Aug	92	11	79	199	33.4	155	84.5	0.0	19.3
	Sept	79	35	72	171	37.8	141	174	83.6	117
NFFR below Canyon Dam (NF-2) [Permanent]	June	36.5	36.5	36.5	36.5	36.1	36.2	35.6	34.7	35.4
	July	36.9	36.1	36.5	36.1	36.1	36.1	37.0	33.4	35.1
	Aug	36.1	35.2	35.8	36.1	35.2	35.6	38.4	34.7	36.1
	Sept	35.2	34.7	34.9	35.2	34.3	35.0	37.9	37.0	37.5
NFFR above Caribou PH (NF4) [Temporary]	June	83.2	77.6	80.1	88.8	72.6	79.4	69.2	65.1	67.0
	July	77.3	74.9	75.9	72.2	66.6	69.1	66.3	63.8	64.9
	Aug	75.4	73.3	74.2	71.8	64.8	66.4	64.6	62.2	63.4
	Sept	73.5	71.2	72.7	64.7	61.8	63.2	64.7	63.3	63.8
Butt Valley Powerhouse (NF-71)	June	1084	0	115	1,320	0.0	919	1,820	0	643
	July	1283	0	746	1,433	800	1,175	1,702	435	1,274
	Aug	1439	159	984	1,818	1,134	1,386	1,726	1,330	1,616
	Sept	1615	504	1436	1,914	0.0	1,339	1,360	499	1,136
Butt Creek at ABC Tunnel (NF-4) [Permanent]	June	71.8	48.3	56.2	214	78.7	123	84.8	57.4	66.7
	July	47.6	43.6	45.6	78.0	63.4	69.5	62.7	49.4	53.1
	Aug	43.8	42.1	42.9	67.8	58.5	61.2	49.4	44.9	47.1
	Sept	42.4	40.9	41.6	58.5	54.5	56.4	48.3	44.6	45.4
Butt Creek at Mouth (BC3) [Temporary]	June	14.2	14.0	14.1	15.9	15.1	15.4	15.4	14.4	14.7
	July	14.2	13.7	13.9	15.1	14.9	15.0	15.6	15.0	15.2
	Aug	14.3	14.1	14.2	15.5	14.8	15.1	15.1	14.8	15.0
	Sept	14.6	14.1	14.3	14.9	14.5	14.7	15.7	15.0	15.3
Caribou No. 1 Powerhouse (NF-63)	June	325	0	21	252	0.0	31.0	466	0	146
	July	564	0	285	997	0.0	346	865	127	539
	Aug	744	129	516	977	135	467	771	232	546
	Sept	716	247	503	610	0.0	272	404	0	171

Table A-2
Summary of Observed Summer Mean Daily Flows (cfs)
(Continued)

Station	Month	2002			2003			2004		
		max	min	mean	max	min	mean	max	min	mean
Caribou No. 2	June	722	108	245	1,296	369	974	911	32.3	347
Powerhouse (NF-263)	July	735	0	332	1,300	0.0	798	1,022	17.1	703
	Aug	719	33	484	1,405	452	948	1,108	818	979
	Sept	1070	245	912	1,253	647	1,100	1,040	638	845
Oak Flat Powerhouse (NF-103)	June	0	116	105	117	108	113	119	105	113
	July	0	116	64.5	116	109	114	117	105	112
	Aug	111	116	114	116	0.0	98.7	116	96.2	112
	Sept	0	114	49.2	112	44.9	56.4	115	54.9	67.4
NFFR below Belden Dam (NF-70) [Permanent]	June	145	143	144	147	141	143	149	144	145
	July	144	142	143	147	141	143	148	142	145
	Aug	144	142	143	147	141	143	146	143	145
	Sept	143	62	69	138	62.9	66.8	146	65.1	81.4
Mosquito Creek At mouth (MC1) [Estimate]	June	7.5	5.1	6.2	16.5	9.0	12.1	8.9	6.3	7.4
	July	5.1	4.2	4.6	9.1	6.2	7.5	6.3	5.5	5.8
	Aug	4.1	4.0	4.1	6.2	4.7	5.4	5.5	5.3	5.4
	Sept	4.2	4.1	4.1	5.4	3.8	4.3	5.3	5.3	5.3
East Branch NFFR near NFFR (NF-51) [Permanent]	June	334	117	187	1,204	225	537	395	127	224
	July	118	51.4	79.9	211	106	148	149.1	58.8	95.8
	Aug	60.9	45.0	52.5	151	84.3	108	64.8	47.0	57.1
	Sept	62.0	48.8	55.9	106	82.5	92.6	75.2	55.7	64.7
Belden Powerhouse (NF-74)	June	830	0	121	1,328	287	955	1,286	0	418
	July	1216	0	518	1,441	742	1,110	1,689	538	1,132
	Aug	1504	241	1001	1,714	769	1,279	1,682	1,107	1,434
	Sept	1513	677	1108	1,788	545	1,329	1,622	609	1,078
Yellow Creek Near mouth (YC1) [Temporary]	June	117	64.5	81.5	210	117	156	178	88.9	122
	July	63.6	52.4	56.9	116	75.3	91.2	101	60.1	71.5
	Aug	53.7	50.8	52.2	85.7	66.0	71.7	59.9	51.9	55.5
	Sept	54.0	48.8	51.3	67.7	61.3	64.0	57.5	50.7	52.4
Chips Creek Near mouth (CHIP) [Estimate]	June	107	33.8	64.3	229	57.9	109	127	47.7	83.6
	July	33.3	18.2	25.7	55.9	27.4	38.5	45.9	17.2	28.2
	Aug	17.7	14.4	15.5	27.0	18.0	21.8	16.8	12.6	14.0
	Sept	14.3	12.4	13.3	17.8	13.5	15.4	12.6	12.3	12.4
NFFR below Rock Creek Dam (NF-57) [Permanent]	June	1133	170	267	1,079	238	281	1,117	272	313
	July	774	150	216	733	193	222	803	249	275
	Aug	553	191	209	540	190	207	707	252	270
	Sept	650	196	229	667	191	213	690	229	259

Table A-2
Summary of Observed Summer Mean Daily Flows (cfs)
(Continued)

Station	Mont	2002			2003			2004		
		max	min	mean	max	min	mean	max	min	mean
Milk Ranch Creek	June	9.8	6.4	8.2	82.8	16.8	38.3	22.2	9.85	14.5
Near mouth	July	6.2	4.1	5.0	16.6	6.3	9.3	9.55	5.67	7.16
(MR1)	Aug	4.2	3.4	3.7	8.9	5.2	7.0	5.66	4.61	5.03
[Temporary]	Sept	3.5	3.2	3.3	5.2	4.3	4.8	4.99	4.33	4.52
Chambers Creek	June	46.9	9.9	25.2	78.3	22.1	41.9	32.3	8.7	17.9
Near mouth	July	9.7	4.6	4.1	21.3	8.8	13.8	8.3	3.8	5.4
(CHAM)	Aug	4.4	3.0	3.5	8.6	4.7	6.4	3.8	3.3	3.5
[Estimate]	Sept	3.0	2.5	2.7	5.0	3.0	3.7	3.3	3.3	3.3
Bucks Creek	June	24.1	19.0	21.7	200	28.6	63.5	26.9	20.7	23.5
Near Mouth	July	18.8	13.8	16.1	28.3	19.2	23.5	20.2	14.5	16.7
(BUCK1)	Aug	13.7	10.7	12.1	20.9	16.7	18.2	14.5	12.1	13.3
[Temporary]	Sept	13.5	10.2	12.2	16.6	15.1	15.8	13.6	11.6	11.9
Bucks Creek	June	51	5	19	338	53.2	273	226	96.4	178
Powerhouse	July	194	1	83	250	0.0	117	262	70.2	132
(NF-20)	Aug	228	0	113	221	1.4	132	241	129	195
	Sept	237	109	171	223	37.8	197	192	33.5	87.5
Rock Creek	June	1342	204	479	2,450	596	1,917	1,210	486	787
Powerhouse	July	1358	97	756	1,701	1,058	1,424	2,007	789	1,327
(NF-64)	Aug	1596	184	1095	2,033	829	1,531	1,867	1,055	1,583
	Sept	1744	422	1466	2,024	545	1,485	1,690	537	1,213
Rock Creek	June	44.5	8.9	21.6	118	13.9	36.2	70.6	10.5	31.4
Near mouth	July	8.7	3.0	5.8	13.1	4.7	7.6	9.7	3.1	4.9
(RC2)	Aug	2.8	2.1	2.3	4.6	2.8	3.5	3.1	2.9	2.9
[Estimate]	Sept	2.1	1.7	1.9	3.4	2.9	3.1	2.9	2.9	2.9
Grizzly Creek	June	38.8	28.9	33.6	72.6	44.5	56.4	51.1	31.0	39.7
Near mouth	July	28.4	20.0	24.1	44.3	24.1	32.9	30.0	18.7	23.4
(GR1)	Aug	20.2	15.1	17.5	28.2	18.1	21.9	18.6	12.5	15.6
[Temporary]	Sept	16.9	12.9	14.6	19.4	14.4	16.4	16.4	10.6	11.7
NFFR below	June	1109	271	321	561	262	325	371	251	279
Grizzly Creek	July	805	235	265	834	269	299	553	248	273
(NF-56) ³	Aug	568	236	260	625	253	284	712	236	273
[Permanent]	Sept	667	240	262	531	175	268	712	254	281
Cresta	June	1576	243	600	3,475	1,515	2,570	1,617	879	1,184
Powerhouse	July	1457	12	820	1,958	1,041	1,543	2,290	885	1,487
(NF-62)	Aug	1698	216	1135	2,209	879	1,620	2,082	1,130	1,766
	Sept	1898	544	1658	2,223	479	1,631	1,818	419	1,287

Appendix B

Summary of Summer 2002 - 2004 Mean Daily Water Temperature Comparison with the 20°C Level

Table B-1

Summary of 2002 Mean Daily Water Temperature Comparison with the 20°C Level.

Station	Month	2002			2003			2004		
		Days Greater 20°C	Total Data Days	Percent Greater 20°C	Days Greater 20°C	Total Data Days	Percent Greater 20°C	Days Greater 20°C	Total Data Days	Percent Greater 20°C
NFFR at Chester (NF1)	June	0	30	0%	0	18	0%	0	30	0%
	July	0	31	0%	0	31	0%	0	31	0%
	Aug	0	31	0%	0	31	0%	0	31	0%
	Sept	0	30	0%	0	30	0%	0	30	0%
Hamilton Branch at Road bridge (HB1)	June	0	30	0%	0	30	0%	0	30	0%
	July	0	31	0%	0	31	0%	0	31	0%
	Aug	0	31	0%	0	31	0%	0	31	0%
	Sept	0	30	0%	0	30	0%	0	30	0%
Hamilton Branch Powerhouse (HB2)	June	0	30	0%	6	30	20%	0	30	0%
	July	0	31	0%	0	22	0%	0	18	0%
	Aug	0	31	0%	0	31	0%	0	8	0%
	Sept	0	30	0%	0	30	0%	0	30	0%
Lake Almanor at Canyon Dam near surface (LA1-S)	June	13	30	43%	---	---	---	13	30	43%
	July	31	31	100%	7	7	100%	31	31	100%
	Aug	31	31	100%	31	31	100%	31	31	100%
	Sept	12	30	40%	13	30	43%	11	30	37%
Lake Almanor at Canyon Dam near bottom (LA1-B)	June	0	30	0%	---	---	---	0	30	0%
	July	0	31	0%	0	7	0%	0	31	0%
	Aug	0	31	0%	0	31	0%	0	31	0%
	Sept	0	30	0%	0	30	0%	0	30	0%
NFFR below Canyon Dam (NF2)	June	0	30	0%	0	30	0%	0	30	0%
	July	0	31	0%	0	31	0%	30	31	97%
	Aug	0	31	0%	0	31	0%	31	31	100%
	Sept	0	30	0%	0	30	0%	0	30	0%
NFFR at Seneca Bridge (NF3)	June	0	30	0%	0	30	0%	0	30	0%
	July	0	31	0%	0	31	0%	0	31	0%
	Aug	0	31	0%	0	31	0%	0	31	0%
	Sept	0	30	0%	0	30	0%	0	30	0%
NFFR above Caribou PH (NF4)	June	0	30	0%	0	30	0%	0	30	0%
	July	0	31	0%	0	31	0%	0	31	0%
	Aug	0	31	0%	0	31	0%	0	31	0%
	Sept	0	30	0%	0	30	0%	0	30	0%
Butt Valley Powerhouse [Corrected] (BV1)	June	0	4	0%	0	28	0%	0	22	0%
	July	20	29	69%	0	31	0%	13	31	42%
	Aug	31	31	100%	9	31	29%	31	31	100%
	Sept	5	30	17%	5	27	19%	3	30	10%

Table B-1

**Summary of 2002 Mean Daily Water Temperature Comparison with the 20°C Level.
(Continued)**

Station	Month	2002			2003			2004		
		Days Greater 20°C	Total Data Days	Percent Greater 20°C	Days Greater 20°C	Total Data Days	Percent Greater 20°C	Days Greater 20°C	Total Data Days	Percent Greater 20°C
Butt Valley Res. at Caribou Intake	June	16	30	53%	16	30	53%	16	30	53%
	July	31	31	100%	22	31	71%	31	31	100%
	Near surface (BV2-S)	31	31	100%	31	31	100%	31	31	100%
	Sept	14	30	47%	13	30	43%	16	30	53%
Butt Valley Res. at Caribou Intake	June	0	30	0%	0	30	0%	0	30	0%
	July	0	31	0%	0	31	0%	8	31	26%
	Near bottom (BV2-B)	15	31	48%	0	31	0%	31	31	100%
	Sept	8	30	27%	0	30	0%	5	30	17%
Butt Creek above Butt Valley Reservoir (BC1)	June	0	30	0%	1	30	3%	0	30	0%
	July	0	31	0%	0	31	0%	0	31	0%
	Aug	0	31	0%	0	31	0%	0	31	0%
	Sept	0	30	0%	0	30	0%	0	30	0%
Butt Creek below Butt Valley Reservoir (BC2)	June	0	30	0%	0	30	0%	0	30	0%
	July	0	31	0%	0	31	0%	0	31	0%
	Aug	0	31	0%	0	31	0%	0	31	0%
	Sept	0	30	0%	0	30	0%	0	30	0%
Butt Creek at Mouth (BC3)	June	0	30	0%	0	30	0%	0	30	0%
	July	0	31	0%	0	31	0%	0	31	0%
	Aug	0	31	0%	0	31	0%	0	31	0%
	Sept	0	30	0%	0	30	0%	0	30	0%
Caribou No. 1 Powerhouse [corrected] (CARB1)	June	0	5	0%	0	2	0%	0	2	0%
	July	10	29	34%	0	14	0%	15	31	48%
	Aug	31	31	100%	0	31	0%	31	31	100%
	Sept	8	31	27%	4	25	16%	6	21	29%
Caribou No. 2 Powerhouse [corrected] (CARB2A)	June	8	30	27%	0	30	0%	14	30	47%
	July	28	28	100%	13	24	54%	26	26	100%
	Aug	31	31	100%	31	31	100%	31	31	100%
	Sept	13	30	43%	14	30	47%	13	30	43%
Belden Reservoir At Intake (BD1)	June	89	30	30%	0	30	0%	0	30	0%
	July	28	31	90%	9	31	29%	25	31	81%
	Aug	31	31	100%	31	31	100%	31	31	100%
	Sept	12	30	40%	10	30	33%	9	30	30%
NFFR below Belden Dam (NF5)	June	0	30	0%	0	30	0%	0	30	0%
	July	7	31	23%	4	31	13%	18	31	58%
	Aug	31	31	100%	10	31	32%	31	31	100%
	Sept	6	30	20%	6	30	20%	4	30	13%

Table B-1
Summary of 2002 Mean Daily Water Temperature Comparison with the 20°C Level.
(Continued)

Station	Month	2002			2003			2004		
		Days Greater 20°C	Total Data Days	Percent Greater 20°C	Days Greater 20°C	Total Data Days	Percent Greater 20°C	Days Greater 20°C	Total Data Days	Percent Greater 20°C
Mosquito Creek At mouth (MC1)	June	0	30	0%	----	0	---	0	30	0%
	July	0	31	0%	----	0	---	0	31	0%
	Aug	0	31	0%	0	27	0%	0	31	0%
	Sept	0	30	0%	0	30	0%	0	30	0%
NFFR near Queen Lily Campground (NF6)	June	0	30	0%	0	30	0%	0	30	0%
	July	7	31	23%	4	31	13%	17	31	55%
	Aug	23	31	74%	1	31	3%	31	31	100%
	Sept	2	30	7%	0	30	0%	1	30	3%
NFFR near Gansner Bar (NF7)	June	0	30	0%	0	30	0%	0	30	0%
	July	13	31	42%	4	31	13%	19	31	61%
	Aug	18	31	58%	2	31	6%	28	31	90%
	Sept	2	30	7%	1	30	3%	0	30	0%
East Branch NFFR at mouth (EB1)	June	21	30	70%	9	30	30%	16	30	53%
	July	31	31	100%	31	31	100%	31	31	100%
	Aug	29	31	94%	31	31	100%	31	31	100%
	Sept	4	30	13%	6	30	20%	3	30	10%
NFFR at Belden Town Bridge (NF8)	June	8	30	27%	4	30	13%	10	30	33%
	July	31	31	100%	22	31	71%	31	31	100%
	Aug	23	31	74%	23	31	74%	31	31	100%
	Sept	3	30	10%	6	30	20%	1	30	3%
Belden Powerhouse (BD2)	June	0	7	0%	0	30	0%	0	20	0%
	July	25	29	86%	9	31	29%	26	31	84%
	Aug	31	31	100%	31	31	100%	31	31	100%
	Sept				10	30	33%	10	30	33%
Yellow Creek Near mouth (YC1)	June	0	30	0%	0	18	0%	0	30	0%
	July	0	31	0%	0	31	0%	0	31	0%
	Aug	0	31	0%	0	31	0%	0	31	0%
	Sept	0	30	0%	0	30	0%	0	30	0%
Chips Creek Near mouth (CHIP1)	June	0	30	0%	0	30	0%	0	30	0%
	July	0	31	0%	0	31	0%	0	31	0%
	Aug	0	31	0%	0	31	0%	0	31	0%
	Sept	0	30	0%	0	30	0%	0	30	0%
NFFR at NF-57 Below Rock Crk Dam (NF10)	June	5	5	100%	0	30	0%	0	30	0%
	July	29	31	94%	13	31	42%	26	31	84%
	Aug	31	31	100%	27	31	87%	31	31	100%
	Sept	5	30	17%	6	30	20%	2	30	7%

Table B-1
Summary of 2002 Mean Daily Water Temperature Comparison with the 20°C Level.
(Continued)

Station	Month	2002			2003			2004		
		Days Greater 20°C	Total Data Days	Percent Greater 20°C	Days Greater 20°C	Total Data Days	Percent Greater 20°C	Days Greater 20°C	Total Data Days	Percent Greater 20°C
Milk Ranch Creek Near mouth (MR1)	June	0	30	0%	0	30	0%	0	30	0%
	July	0	31	0%	0	31	0%	0	31	0%
	Aug	0	31	0%	0	31	0%	0	31	0%
	Sept	0	30	0%	0	30	0%	0	30	0%
Chambers Creek Near mouth (CHAM1)	June	0	30	0%	0	30	0%	0	30	0%
	July	0	31	0%	0	31	0%	0	31	0%
	Aug	0	31	0%	0	31	0%	0	31	0%
	Sept	0	30	0%	0	30	0%	0	30	0%
NFFR near Tobin Blw Granite Crk (NF11)	June	6	30	20%	0	30	0%	3	30	10%
	July	31	31	100%	20	31	65%	28	31	90%
	Aug	29	31	94%	22	31	71%	31	31	100%
	Sept	4	30	13%	6	30	20%	2	30	7%
Jackass Creek Near mouth (JC1)	June	0	30	0%	0	30	0%	0	30	0%
	July	0	31	0%	1	31	3%	0	31	0%
	Aug	0	31	0%	0	31	0%	0	31	0%
	Sept	0	30	0%	0	30	0%	0	30	0%
NFFR abv Bucks Creek (NF12)	June	6	30	20%	0	30	0%	4	30	13%
	July	31	31	100%	20	31	65%	29	31	94%
	Aug	28	31	90%	21	31	68%	31	31	100%
	Sept	4	30	13%	6	30	20%	2	30	7%
Bucks Creek Near Mouth (BUCK1)	June	0	30	0%	0	30	0%	0	30	0%
	July	2	31	6%	5	31	16%	0	31	0%
	Aug	0	31	0%	0	31	0%	0	31	0%
	Sept	0	30	0%	0	30	0%	0	30	0%
Bucks Creek Powerhouse (BUCK2)	June	0	27	0%	0	30	0%	0	30	0%
	July	0	26	0%	0	28	0%	0	31	0%
	Aug	0	21	0%	0	29	0%	0	31	0%
	Sept	0	30	0%	0	30	0%	0	29	0%
NFFR abv Rock Creek Powerhouse (NF13)	June	6	30	20%	0	30	0%	0	30	0%
	July	26	31	84%	4	31	13%	6	31	19%
	Aug	10	31	32%	7	31	23%	0	31	0%
	Sept	0	30	0%	0	30	0%	0	30	0%
Rock Creek Powerhouse (RC1)	June	1	30	3%	0	30	0%	3	30	10%
	July	29	31	94%	17	31	55%	29	31	94%
	Aug	31	31	100%	31	31	100%	31	31	100%
	Sept	11	30	37%	10	30	33%	18	30	60%

Table B-1

**Summary of 2002 Mean Daily Water Temperature Comparison with the 20°C Level.
(Continued)**

Station	Month	2002			2003			2004		
		Days Greater 20°C	Total Data Days	Percent Greater 20°C	Days Greater 20°C	Total Data Days	Percent Greater 20°C	Days Greater 20°C	Total Data Days	Percent Greater 20°C
Rock Creek	June	0	30	0%	0	30	0%	0	30	0%
Near mouth (RC2)	July	0	31	0%	5	31	16%	0	31	0%
	Aug	0	31	0%	7	31	23%	0	31	0%
	Sept	0	30	0%	0	30	0%	0	30	0%
NFFR abv Grizzly Creek (NF14)	June	4	30	13%	0	30	0%	0	30	0%
	July	31	31	100%	10	31	32%	24	31	77%
	Aug	27	31	87%	11	31	35%	30	31	97%
	Sept	4	30	13%	2	30	7%	0	30	0%
Grizzly Creek Near mouth (GR1)	June	0	30	0%	0	18	0%	0	30	0%
	July	8	31	26%	8	31	26%	2	31	6%
	Aug	3	31	10%	0	31	0%	0	31	0%
	Sept	0	30	0%	0	30	0%	0	30	0%
NFFR at NF-56 blw Grizzly Crk (NF15)	June	5	30	17%	0	30	0%	0	30	0%
	July	31	31	100%	14	31	45%	24	31	77%
	Aug	26	30	84%	12	31	39%	29	31	94%
	Sept	4	30	13%	4	30	13%	0	30	0%
NFFR abv Cresta Powerhouse (NF16)	June	6	30	20%	0	30	0%	1	30	3%
	July	31	31	100%	17	31	55%	28	31	90%
	Aug	28	31	90%	14	31	45%	31	31	100%
	Sept	4	30	13%	5	30	17%	2	30	7%
Cresta Powerhouse (CR1)	June	5	30	17%	0	30	0%	0	30	0%
	July	30	30	100%	13	31	42%	24	31	77%
	Aug	31	31	100%	16	31	52%	31	31	100%
	Sept	5	30	17%	2	30	7%	2	30	7%
Middle Fork Feather River At Milsap Bar (MB1)	June	6	30	20%	0	14	0%	2	30	7%
	July	31	31	100%	15	22	68%	27	31	87%
	Aug	16	31	52%	7	31	23%	20	31	65%
	Sept	0	26	0%	0	16	0%	0	30	0%

Appendix C

Evaluation of Potential Measures for Reducing Water Temperature in the North Fork Feather River

EVALUATION OF POTENTIAL MEASURES FOR REDUCING WATER TEMPERATURE IN THE NORTH FORK FEATHER RIVER

The purpose of this report is to present and describe a comprehensive set of measures that may potentially reduce water temperature along all or a part of the NFFR. The geographic scope of the measures covers the entire UNFFR Project area as defined in the NOP. The measures mainly consist of physical and operational changes to existing UNFFR Project facilities, but changes to other PG&E-owned and non-PG&E-owned facilities in the NFFR basin are considered as well. Watershed management actions that may potentially reduce temperature are included too.

The potential temperature reduction measures described herein derive from those described in PG&E's 24 Alternatives Report (PG&E 2005b) as well as others developed by the State Water Board team. A brief description of each potential measure and a preliminary evaluation of its effectiveness in reducing temperature or its feasibility, in terms of constructability, cost, or logistics, are provided. Some of the initial evaluations conclude that certain measures are clearly ineffective or infeasible because they would not be effective or they are extremely costly, and those measures have been eliminated from further consideration. A final list is provided that contains the measures passing the preliminary evaluation: These measure are eligible for selection and inclusion in Level 1 alternatives.

MEASURES ABOVE OR AT LAKE ALMANOR

1. Increase release of cold water from Lake Almanor

a. to Butt Valley Reservoir through closely controlled, selective withdrawal from the Prattville Intake by installing a thermal curtain or other device

This measure consists of installing a thermal curtain in Lake Almanor at the existing Prattville Intake to cause colder water to enter the intake for release to the NFFR. PG&E evaluated six thermal curtains of different sizes and layouts and conducted physical model tests to compare and select the most effective and viable thermal curtain (IIHR, 2004). The most effective thermal curtain configuration is U-shaped, 900-feet x 770-feet x 900-feet. The most effective elevation of the curtain bottom is 4,455 ft (USGS datum). This configuration (without dredging of the Prattville Intake area) provides about 4.4°C and 3.6°C water temperature reduction at the Butt Valley PH during July and August respectively at its normal operating discharge of 1,600 cfs. (Note: The impacts of different discharges on outflow temperatures were tested by PG&E using the physical model, but the impacts of ON/OFF peaking operations on outflow temperatures were not tested).

PG&E also considered installing a submerged hooded pipeline at the existing Prattville Intake to cause colder water to enter the intake for release to the NFFR. PG&E evaluated two configurations (long and short) of a submerged hooded pipeline (three 12-foot

diameter pipes) and conducted physical model tests to compare and select the most effective and viable measure between the submerged hooded pipeline and thermal curtain. The thermal curtain measure was determined to be more effective.

Conclusion: Consider this measure.

b. to the Seneca Reach through selective withdrawal from the existing Canyon Dam Outlet

This measure consists of re-operating the existing Canyon Dam Outlet to selectively withdraw warmer surface water through the high level outlet gates during the spring in a manner that would preserve more cold water in Lake Almanor and make it available for release to the NFFR through the Prattville Intake. During the summer, selectively release cold water to the Seneca Reach through the low level outlet at Canyon Dam. Evaluation of selective operation of the high/low outlet gates by PG&E indicated only a slight benefit was achievable; about 0.1°C cooler in water temperatures in Lake Almanor at the Prattville Intake. Such minor water temperature reduction at Prattville Intake would not produce measurable water temperature benefits in the Belden, Rock Creek, Cresta and Poe reaches.

Conclusion: Eliminate this measure.

c. to Butt Valley Reservoir through reduced withdrawal from the Prattville Intake

This measure consists of reducing Butt Valley Powerhouse flows so that cooler water is drawn from Lake Almanor and subsequently released to the NFFR system from the Butt Valley Powerhouse. It is expected that reducing Butt Valley Powerhouse flows to a point that allows selective cold water withdrawal would result in measurable water temperature reduction to the Belden, Rock Creek, Cresta and Poe reaches. Data collected by PG&E in August 1994 suggests that reduced intake velocities at the Prattville Intake and the resulting decrease of Butt Valley PH discharge to below 800 cfs will result in selective withdrawal of colder water from Lake Almanor.

Conclusion: Consider this measure.

d. to the Seneca Reach through increased cold water releases from the Canyon Dam low-level outlet

This measure consists of increasing the magnitude of cold water releases to the NFFR from the Canyon Dam Outlet low level gate. The amount of temperature reduction of this measure depends on the relative magnitude of the Canyon Dam releases and Caribou PH discharges. Increasing Canyon Dam releases would reduce warming in the Seneca Reach (Figure 1 shows that warming in the Seneca Reach above Caribou PH would reduce by about 1°C if dam release increases from 80 cfs to 400 cfs). Increasing Canyon Dam releases would enhance water temperature reduction in Belden Reservoir, which would benefit all downstream reaches. Increasing Canyon Dam release would require

decreasing Prattville Intake release commensurately to avoid lake level fluctuation or changes from the operating rules agreed to in the Partial Settlement Agreement.

Conclusion: Consider this measure.

- ***Enhancement measure for both 1a and 1b would be to dredge the lake bottom levees in the Prattville Intake area***

This measure consists of dredging of the Prattville Intake area and the nearby underwater channel at Lake Almanor exclusively or in combination with installing a thermal curtain or submerged pipeline to cause colder water to enter the intake for release to the NFFR. Physical model tests were conducted by PG&E to compare and select the most effective and viable combination of dredging, submerged pipeline and thermal curtain. Dredging alone provides about 1.4°C and 1.6°C water temperature reduction at the Butt Valley PH during July and August respectively at its normal operating discharge of 1,600 cfs (IIHR, 2004).

Conclusion: Consider this measure.

- ***Enhancement measure for 1a to 1d would be to increase the inflow supply of cooler water into Lake Almanor (to prevent depletion of the hypolimnion).***

- *by constructing an expansive, high-capacity wellfield that would pump directly from the basalt aquifer discharging to Big Springs/northeastern Lake Almanor. The pumped cold water could be discharged either (a) to the lake hypolimnion from where it would flow submerged to the Prattville Intake, or (b) conveyed by pipeline laid along the lakebed and connected for direct discharge into the Intake.*

This enhancement measure consists of constructing a high-capacity wellfield near Big Springs and pumping the cold groundwater (about 8°C) and conveying it by pipeline either to the lake hypolimnion from where it would flow submerged to the Prattville Intake or by pipeline laid along the lakebed and connected, for direct discharge, to the Intake for release to the NFFR. Constructing a high-capacity wellfield near Big Springs and pumping the cold groundwater directly into the Prattville Intake would reduce outflow temperature at Butt Valley PH by about 1°C for every 100 cfs of the pumped groundwater at the powerhouse's normal operating discharge of 1,600 cfs (Figure 2). Little information is available on the hydrogeology and development potential of the basalt aquifer at Lake Almanor. Extensive field investigation would be required to evaluate the feasibility of this measure.

Conclusion: Consider this measure.

- *by connecting a conduit to the Hamilton Branch tailrace that extends out into the depths of Lake Almanor to replenish the hypolimnion with cool water.*

This enhancement measure consists of connecting a conduit to the Hamilton Branch tailrace that extends out into the depths of Lake Almanor to replenish the hypolimnion with cool water. The Hamilton Branch PH discharge temperatures are variable (range from 12°C to 19°C) and depend on the regulated discharge. When the powerhouse flows are greater than about 50 cfs, the powerhouse discharge temperatures are considerably warmer (by up to 5°C). Therefore replenishing Lake Almanor hypolimnion using Hamilton Branch PH discharges would not be a reliably effective water temperature reduction measure.

Conclusion: Eliminate this measure.

- *by purchasing water rights along the UNFFR and Hamilton Branch above Lake Almanor and transferring the water rights to instream use or changing the point of diversion to below Oroville thereby causing cooler inflows into Lake Almanor by preventing the warming effect of diversions and return flows above the lake.*

The UNFFR above Chester is close to natural and Hamilton Branch above Lake Almanor is natural except the use by PG&E. Therefore, this enhancement measure would not be an effective water temperature reduction measure.

Conclusion: Eliminate this measure.

- *by reducing warming along the UNFFR and Hamilton Branch above Lake Almanor by increasing shading through planting of vegetation thereby causing cooler inflows.*

Observed average water temperatures in July 2002 at the upper NFFR and Hamilton Branch above Lake Almanor were 15.7°C and 12.0°C respectively. These cool water temperatures suggest that warming in these streams is not important. It is expected that the benefit of increasing shading along these two streams would be minimal. Therefore, this enhancement measure would not be an effective water temperature reduction measure.

Conclusion: Eliminate this measure.

- ***Enhancement measure for 1a to 1d would be to raise the elevation of the dam/spillway and/or seasonal operating levels of the lake to raise the level of the top of the hypolimnion and increase its overall volume.***

This measure consists of raising the elevation of the dam/spillway and/or seasonal operating levels of the lake to increase the hypolimnion depth. The purpose would be to increase the storage volume of the hypolimnion and to enhance the hydraulic conveyance of cold water to the Prattville Intake. Lake Almanor subsurface hydraulics limits the amount of cold water that can be conveyed through the hypolimnion to the Prattville Intake. Increasing the depth of the hypolimnion may enhance cold water withdrawal by improving hydraulics. This benefit would need to be analyzed and tested through physical modeling or numerical modeling.

The maximum operating water level allowed by the DWR/DSOD is elevation 4,504 ft (USGS datum). PG&E right-of-way for flooding on waterfront lands is 4,510 ft (USGS datum). Raising the dam would require significant and costly modifications to the dam, as well as costly modifications to affected waterfront structures and the purchase of right-of-way to flood waterfront lands.

Conclusion: Eliminate this measure.

MEASURES AT BUTT VALLEY RESERVOIR

2. Increase release of cold water from Butt Valley Reservoir

a. to Belden Reservoir through preferential use of Caribou PH #1

This measure consists of preferentially operating the Caribou No. 1 Powerhouse over the Caribou No. 2 Powerhouse, thereby drawing cooler water from Butt Valley Reservoir for release to the NFFR. Because the Caribou No. 1 Powerhouse water intake is located in a deeper portion of Butt Valley Reservoir than the Caribou No. 2 Powerhouse water intake, it has better access to the deeper cooler water. A special operational test conducted with the exclusive use of Caribou No. 1 Powerhouse during the 8-day period of 7/18/2003 – 7/25/2003 resulted in downstream water temperature reductions of 3.0°C at Belden Reservoir, 2.5°C below Belden Dam, 1.1°C below Rock Creek Dam, 0.3°C below Cresta Dam, and 0.3°C below Poe Dam. The discharge water temperature from Caribou No. 1 Powerhouse during the test period increased steadily from 16.4°C to 18.4°C (see Table 1 and Figure 3). This special test provided very important information: Decreasing water temperature in Belden Forebay from approximately 20°C to 17.5°C would have minimal benefit in water temperature reduction below Cresta Dam and Poe Dam.

Conclusion: Consider this measure.

b. to Lower Butt Creek through releases from a new low level Butt Valley Dam Outlet

This measure consists of constructing a low level outlet at Butt Valley Dam and releasing water from the outlet and reducing Caribou Powerhouse flows so that cooler water is drawn from the new outlet and subsequently released to the NFFR. The Caribou No.1 Intake is located at an invert elevation of 4,077 ft (USGS datum), which is a low level intake. Constructing a new low level outlet at the dam, which would be close to the Caribou No.1 Intake, is not necessary because Caribou No.1 already provides a means for delivering cool Butt Valley Reservoir water to Belden Reservoir. This measure is not a necessary water temperature reduction measure.

Conclusion: Eliminate this measure.

c. to Belden Reservoir by directly conveying Butt Valley PH discharge to Butt Valley Reservoir near the Caribou Intakes.

This measure consists of constructing a 5 mile pipeline laid along the bed of Butt Valley Reservoir for conveying Butt Valley PH discharge to Butt Valley Reservoir near the Caribou Intakes for the purpose of reducing warming that occurs as the water flows through Butt Valley Reservoir. Under this measure, outflow temperature from the Caribou PH would be the same as the discharge temperature at Butt Valley PH. This measure would reduce outflow temperature from Caribou PH by 1°C to 2°C in July and August under existing intake configurations.

Conclusion: Consider this measure.

- Enhancement measure for 3a would be to construct a “crossover” conduit connecting Caribou No. 1 to Caribou No. 2.

This enhancement measure consists of constructing a conduit connecting Caribou No.1 to Caribou No.2. This would enable drawing cooler water from Butt Valley Reservoir while using the higher efficiency turbine of Caribou No.2. This is primarily a power generation enhancement measure with some additional temperature reduction benefit attributable to preferential use of Caribou No.1.

Conclusion: Consider this measure.

- Enhancement measure for both 3a and 3b would be to install thermal curtain across Butt Valley Reservoir at the Butt Valley PH and Caribou Intake.

This enhancement measure consists of installing a combination of one thermal curtain at the Prattville Intake in Lake Almanor and two thermal curtains in Butt Valley Reservoir, with dredging of the Prattville Intake. PG&E conducted physical model tests to compare and select the most effective and viable combination of dredging, submerged pipeline and thermal curtain. The most effective thermal curtain with dredging provides 5.8°C and 5.2°C water temperature reduction at the Butt Valley PH during July and August respectively at its normal operating discharge of 1,600 cfs. (Note: The impacts of ON/OFF peaking operations on outflow temperatures were not tested).

Warming in Butt Valley Reservoir is about 1°C - 2°C in July and August under existing conditions. Warming in Butt Valley Reservoir would be more pronounced if the Prattville thermal curtain was installed and cooler water entered the reservoir. PG&E investigated measures to minimize Butt Valley Reservoir warming under the Prattville thermal curtain condition. PG&E considered two potential thermal curtain options in Butt Valley Reservoir: (1) two thermal curtains, one installed up-reservoir near the Butt Valley Powerhouse discharge and another installed down-reservoir near the Caribou No. 1 and No. 2 intakes, (2) one thermal curtain installed up-reservoir only. On average, the two curtain option (with the Prattville thermal curtain installed) resulted in reduced warming in Butt Valley Reservoir of about 0.9 to 2.5°C for July and August based on the

preliminary results from the numerical model MITEMP. But the 2006 special test demonstrated that cold water plunges at the entrance of Butt Valley Reservoir making the up-reservoir curtain unnecessary.

Conclusion: Consider this measure (one down-reservoir curtain only).

- ***Enhancement measure for both 3a and 3b would be to raise the elevation of the dam/spillway and/or seasonal operating levels of the reservoir to raise the top of the hypolimnion and its overall volume.***

This enhancement measure consists of raising the elevation of the dam/spillway and/or seasonal operating levels of the reservoir to increase the hypolimnion depth. The purpose would be to increase the storage volume of the hypolimnion and to improve hydraulics and enhance its ability to convey cold water to the Caribou Intake. Butt Valley Reservoir subsurface hydraulics limit the amount of cold water that can be conveyed through the hypolimnion to the Caribou Intake. Increasing the depth of the hypolimnion may enhance cold water withdrawal by improving hydraulics. This benefit would need to be analyzed and tested through physical modeling or numerical modeling.

Raising the dam would require significant and costly modifications to the existing dam structure, Butt Valley PH tailrace, and the purchase of additional right-of-way to flood waterfront lands.

Conclusion: Eliminate this measure.

MEASURES ALONG SENECA REACH

3. Reduce warming along the Seneca Reach by increasing shading through planting of vegetation.

This measure consists of performing streamside vegetation management and planting on the Seneca Reach to promote shading and reduce warming, and thus decrease water temperature at Belden Forebay. Existing shading of the Seneca Reach is approximately 53%. Existing warming in the Seneca Reach is about 4°C at Canyon Dam release rate of 35 cfs. Water temperature modeling tests indicate that, if Canyon Dam release is increased to 80 cfs, by increasing shading by 20 percent (i.e., total shading increases to 64%) warming is only reduced by about 0.4°C. The warming reduction benefit for higher releases at Canyon Dam by increasing streamside shading of the Seneca Reach would be less. In addition, this marginal warming reduction benefit would be muted by relatively high discharges from Caribou PHs. Therefore, this measure would not be an effective water temperature reduction measure.

Conclusion: Eliminate this measure.

MEASURES ALONG BELDEN REACH

4. Increase release of cold water to the Belden Reach

a. by increasing release of cold water from Belden Dam Outlet/Oak Flat PH

This measure consists of re-operating Belden Dam to provide increased magnitude water releases from Belden Dam to cool the Belden Reach of the NFFR. Note that increasing releases from Belden Dam could only reduce warming along the reach, not reduce water temperature at the starting point of the reach. Water temperature modeling indicates that increased magnitude of water releases from Belden Dam would reduce warming very slightly if the dam release temperature is higher than 19°C. Increasing the magnitude of water releases from Belden Dam from 80 cfs to 200 cfs would reduce warming by about 0.4°C and 0.6°C if dam release temperatures are 18°C and 17°C, respectively (Figure 4).

Conclusion: Consider this measure.

b. by constructing a bypass pipeline to convey cold Seneca Reach flows around Belden Reservoir to the Belden Reach.

This measure consists of constructing and operating a new diversion dam (e.g., inflatable/deflatable rubber dam) and about one mile water pipeline to deliver cooler water at the end of the Seneca Reach to the NFFR immediately below Belden Dam. Based on observed average mean daily flow and water temperature data in July and August 2002 (dry year), this measure would cool water below Belden Dam by approximately 1.9°C and 3.0°C in July and August, respectively.

Conclusion: Consider this measure.

c. by operating Caribou PH in strict peaking mode with several hours shut down time to prevent mixing at the Caribou PH/Seneca confluence and thereby allow cold Seneca Reach flows (enhanced by increasing Canyon Dam releases to the Seneca Reach) to submerge in Belden Reservoir for release to downstream reaches.

The July 2003 Caribou special test indicated that Belden Reservoir exhibits stratification (Figure 5). This is beneficial to the Belden Reach since the Belden Dam instream flow outlet is located at a depth of 90 - 100 ft. This benefit has already been used under existing operating conditions. The purpose of this measure would be to strengthen the stratification and enhance the benefit.

The stratification in Belden Reservoir may result from submerged cold water inflows from the Seneca Reach during Caribou off-peak hours. The degree of Belden Reservoir stratification would be affected by release rate at Canyon Dam, the duration of off-peak

hours of the Caribou PH, and on-peak discharge rates at the Caribou PH. It is expected that increasing Canyon Dam releases, extending Caribou off-peak hours, or conveying cold Seneca Reach flows directly to an appropriate plunging location in Belden Reservoir would strengthen the stratification and enhance the benefit. Cold water plunging during Caribou off-peak hours and resulting strengthening of the stratification in Belden Reservoir were verified in the 2006 special test (2006 North Fork Feather River Special Testing Data Report, Stetson and PG&E, March 2007).

Conclusion: Consider this measure.

d. by constructing a pipeline to convey cold Seneca Reach flows (enhanced by increasing Canyon Dam releases to the Seneca Reach) to an appropriate plunging location in Belden Reservoir

This measure consists of constructing a new diversion dam (e.g., inflatable/deflatable rubber dam) and about 1,500 ft of pipeline to convey cold Seneca Reach flows to an appropriate location in Belden Reservoir for the cold water to submerge. For example, location A on Figure 6 could be a potential plunging point. It is expected this measure would strengthen Belden Reservoir stratification and reduce the temperature of Belden Dam water releases to the Belden Reach.

Conclusion: Consider this measure.

e. by constructing a mechanical water cooling tower or chiller at a site

• below Belden Dam

This measure consists of constructing and operating a mechanical water cooling tower or chiller at Belden Dam to cool incoming river water and delivering it back to the NFFR immediately downstream of the dam. The amount of water temperature reduction below Belden Dam would depend on the amount of flow delivered to the cooling tower or chiller and the degree of cooling by the cooling tower or chiller (Figure 7).

Conclusion: Consider this measure.

• at the Belden Adit

This measure consists of constructing and operating a mechanical water cooling tower or chiller at the Belden Adit to cool a portion of the tunnel water and delivering it back to the NFFR immediately downstream of the dam. The amount of water temperature reduction below Belden Dam would depend on the amount of flow delivered to the cooling tower or chiller and the degree of cooling by the cooling tower or chiller.

Conclusion: Consider this measure.

5. Reduce warming along the lower Belden Reach by constructing a bypass pipeline to convey warm East Branch flows directly into Rock Creek Reservoir, bypassing the lower Belden Reach.

This measure consists of constructing a new diversion structure at the mouth of the East Branch (e.g., inflatable/deflatable rubber dam) and about 1.7 mile water pipeline to deliver warm water directly into the epilimnion of Rock Creek Reservoir. The relatively high discharges from Belden PH would mute this diverted warm water in the reservoir. This measure would significantly reduce water temperature of the lower Belden Reach below the East Branch.

Conclusion: Consider this measure.

6. Reduce warming of Belden Reach by increasing shading through planting of vegetation.

This measure consists of performing streamside vegetation management and planting along the Belden Reach to promote shading and thereby reduce warming. Existing shading of the upper Belden Reach before the East Branch and the lower Belden Reach after the East Branch is approximately 40% and 3% respectively. Warming in July 2002 in the upper Belden Reach was not significant (about 0.5°C) primarily because of relatively high existing shading. Warming in the lower Belden Reach was also not significant because of short length and relatively high flow rate in this segment. Water temperature modeling indicates that the benefit of increasing shading along the entire Belden Reach would be minimal. This measure would not be an effective water temperature reduction measure.

Conclusion: Eliminate this measure.

7. *Reduce warming along the East Branch by increasing shading through planting of vegetation.*

This measure consists of performing streamside vegetation management and planting along the East Branch Feather River and its tributaries to promote shading and reduce water temperatures. The East Branch flows into the NFFR about 1.7 miles upstream of Rock Creek Reservoir. The flow at the mouth of East Branch in July 2002 was about one third of the lower Belden Reach flow below the East Branch confluence. Reducing water temperature by 1°C at the mouth of East Branch would reduce water temperature at the lower Belden Reach immediately below the East Branch confluence by about 0.3°C. Any water temperature benefits of streamside vegetation management along the East Branch or its tributaries would be beneficial mostly to the lower Belden Reach, because the much higher discharges from the Belden Powerhouse would mute this temperature benefit once these two discharges mix in Rock Creek Reservoir.

Conclusion: Consider this measure.

8. Replace discharge of warm water into the UNFFR from the East Branch with cooler water by collecting and discharging thermally stratified cold water to the NFFR

a. by constructing a new reservoir on the upper East Branch

This measure consists of constructing and operating a new large dam and reservoir on the East Branch Feather River or its tributaries to store cool water for later release to the East Branch. The East Branch flows into the NFFR upstream of the Rock Creek, Cresta, and Poe reaches. A new dam would need to have sufficient water depth and volume to produce a large quantity of stratified cold water. PG&E evaluated three potential sites for a new dam and reservoir. However, given the very long travel distance (30 to 40 river miles) and significant warming effect of the East Branch Feather River, cold water released from a new dam would not be expected to result in measurable water temperature changes at the Rock Creek, Cresta and Poe reaches. This measure would not be an effective water temperature reduction measure.

Conclusion: Eliminate this measure.

b. by enlarging the existing reservoir on the upper East Branch

This measure consists of enlarging and operating an existing dam and reservoir on the East Branch Feather River or its tributaries to provide a large amount of thermally stratified cold water for later release to the East Branch. The East Branch flows into the NFFR upstream of the Rock Creek, Cresta, and Poe reaches. An enlarged dam would need to have sufficient depth and volume to produce a large quantity of stratified cold water. PG&E evaluated potential enlargement of the existing Round Valley Dam and Reservoir as the most promising dam for this measure. However, the evaluation concluded that the annual runoff for the Round Valley basin is not large enough to produce the water volume needed to sustain an enlarged reservoir. This finding combined with the finding in 9a leads to the conclusion that enlargement of an existing dam is not an effective water temperature reduction measure.

Conclusion: Eliminate this measure.

9. Replace discharge of warm water into the UNFFR from the East Branch with cooler water by purchasing water rights and transferring the water rights to instream use or changing the point of diversion to below Oroville thereby causing cooler inflows into the UNFFR by preventing the warming effect of diversions and return flows along the East Branch above the confluence.

This measure consists of purchasing water rights in the East Branch watershed and transferring the water rights to instream use for the purpose of preventing the warming effect of diversions and return flows along the East Branch. Existing flow at the mouth of East Branch in July 2002 was about one third of the lower Belden Reach below the East Branch confluence. Reducing 1°C of water temperature at the mouth of East Branch from this measure would reduce water temperature at the lower Belden Reach by 0.3°C. Little

information is available on the effects of diversions and return flows on warming along the East Branch. Extensive study would be required to evaluate the effectiveness of this measure.

Conclusion: Eliminate this measure.

10. Reduce temperature of East Branch inflows to the NFFR by stream channel restoration efforts in the upper East Branch drainage

This measure consists of stream channel restoration and improvement efforts on first and second order streams in the headwaters of the East Branch, as described in the Plumas County proposal (Appendix D). Data comparing thermal conditions in the tributaries before and after completion of stream channel restoration and meadow re-watering projects demonstrate significant reductions in water temperature within each local drainage area. These focused channel improvement projects are effective in reaching the goals of temperature reduction, wetland habitat enhancement, and increased seasonal release of cool groundwater to the localized stream system. However, benefits are limited by scale and there is no evidence that incremental improvements in the headwater streams can be sustained through the third and fourth order stream for benefit in the NFFR. Application of a simple mass balance equation to assess the preservation capability for flow and temperature contributions from treated headwater streams shows that benefits are overwhelmed by East Branch conditions with no measurable improvement at the confluence of the NFFR. This measure should be appreciated for its off-site potential, but removed from further evaluation in the NFFR alternatives screening.

Conclusion: Eliminate this measure.

MEASURES ALONG ROCK CREEK REACH

11. Increase release of cold water to the Rock Creek Reach

a. by increasing release of cold water from Rock Creek Dam

This measure consists of re-operating Rock Creek Dam to provide increased magnitude water releases at Rock Creek Dam to cool the Rock Creek Reach of the NFFR. Note that increasing release from Rock Creek Dam can only reduce warming, not reduce the temperature of water at the starting point of the Rock Creek Reach. Water temperature modeling tests indicate that the warming reduction benefit by increasing the magnitude of water releases at Rock Creek Dam is more measurable if the dam release temperature is lower than 20°C (Figure 8).

Conclusion: Consider this measure.

b. by constructing a new reservoir on the upper Yellow Creek to collect and discharge thermally stratified cold water to the UNFFR/Rock Creek Reservoir.

This measure consists of constructing and operating a new large dam and reservoir on Yellow Creek or its tributaries to store cool water for later release to Yellow Creek. Yellow Creek flows into the NFFR upstream of the Rock Creek, Cresta, and Poe reaches. A new dam would need to have sufficient water depth and volume to produce a large quantity of stratified cold water. Existing summer water temperatures at the mouth of Yellow Creek are cold. Constructing a reservoir on the upper Yellow Creek or its tributaries to produce stratified cold water is not expected to improve temperature conditions beyond existing. This measure is not an effective water temperature reduction measure.

Conclusion: Eliminate this measure.

c. by constructing a bypass pipeline to convey cold Yellow Creek/Chips Creek flows around Rock Creek Reservoir to the Rock Creek Reach

This measure consists of constructing a new diversion dam (e.g., inflatable/deflatable rubber dam) and about three miles of water pipeline to deliver cooler water to the NFFR immediately below Rock Creek Dam. Based on observed average mean daily flow and water temperature data in July and August 2002 (dry year), this measure would cool water below Rock Creek Dam by about 1.6°C and 1.8°C in July and August, respectively.

Conclusion: Consider this measure.

d. by constructing a mechanical water cooling tower or chiller at the site of PG&E's Rogers Flat Station for discharge to the Rock Creek Reach

This measure consists of constructing and operating a mechanical water cooling tower or chiller at the site of PG&E's Rogers Flat Station to cool Rock Creek Reservoir water and deliver it back to the NFFR immediately downstream of Rock Creek Dam. The amount of water temperature reduction below Rock Creek Dam depends on the amount of flow delivered to the cooling tower or chiller and the degree of cooling by the cooling tower or chiller (Figure 9).

Conclusion: Consider this measure.

e. by constructing a bifurcation berm/wall/partition within Yellow Creek channel and upstream of Rock Creek Reservoir to separate Yellow Creek flows from Belden PH discharges and Belden Reach flows, thereby preventing mixing and thus allowing cooler Yellow Creek flows to submerge in Rock Creek Reservoir for release to downstream reaches.

Rock Creek Reservoir exhibits weak stratification (Figure 10). This is beneficial to the Rock Creek Reach. This benefit has already been used under existing conditions. The purpose of this measure, combined with the following enhancement measures, would be to strengthen the stratification and enhance the benefit.

The weak stratification in Rock Creek Reservoir may result from submerged cold water inflows from Yellow Creek during Belden PH off-peak hours and submerged cold water inflows from Chips Creek. Under existing conditions, cold water inflows from Yellow Creek mix with warm discharges from Belden PH during on-peak hours and partially mix with warm inflows from Belden Reach during Belden PH off-peak hours. It would be expected that the stratification in Rock Creek Reservoir could be strengthened by constructing a bifurcation berm/wall/partition within Yellow Creek channel and upstream of Rock Creek Reservoir to separate Yellow Creek flows from Belden PH discharges and Belden Reach flows (Figure 11) to prevent mixing and thereby allow cooler Yellow Creek flows to submerge in Rock Creek Reservoir.

Conclusion: Consider this measure.

f. by constructing a diversion and bypass pipeline to capture and convey cold Yellow Creek flows directly to an appropriate plunging location of Rock Creek Reservoir

This measure consists is very similar to the measure 11e above, except that this measure calls for a diversion dam and pipeline to capture and convey the water for discharge at an appropriate location at the reservoir bottom.

Conclusion: Consider this measure.

- Enhancement measure for 11e or 11f would be to dredge a submerged channel in Rock Creek Reservoir

This enhancement measure consists of dredging a submerged channel in Rock Creek Reservoir for providing additional depth for cold water plunging and transport. This enhancement measure, in combination with measure 11e or 11f, would reduce cold water mixing with warm surface water during cold water transport through the reservoir and thereby provide temperature reduction benefit to Rock Creek Reach. Cold water movement along a submerged channel with little mixing with warm surface water was demonstrated in the 2006 special test in Butt Valley Reservoir (2006 North Fork Feather River Special Testing Data Report, Stetson and PG&E, March 2007).

Conclusion: Consider this measure.

- Enhancement measure for 11e or 11f and the enhancement measure above would be to construct a low level outlet at Rock Creek Dam

This enhancement measure in combination with measure 11e or 11f and the enhancement measure above would enhance the stratification benefit to Rock Creek Reach. Currently there are two gates at Rock Creek Dam for making instream flow releases; one is at a depth of about 15 ft and the other is at a depth of about 40 ft. The lower gate (30" diameter) has a capacity of approximately 150 cfs. At higher releases the upper gate is opened. The existing lower gate is not low enough and has insufficient capacity for

higher instream flow releases. Constructing a low level outlet at Rock Creek Dam would provide access to the bottom colder water in the reservoir.

Conclusion: Consider this measure.

12. Increase release of cold water to the lower Rock Creek Reach by increasing release of cold water to the Rock Creek Reach from Lower Bucks Lake/Bucks Creek.

This measure consists of re-operating and/or reconfiguring the Bucks Creek Project to increase releases and thereby reduce water temperatures along the lowest portion of the Rock Creek Reach. The Bucks Creek PH discharges into the NFFR about 1.2 miles upstream of Cresta Reservoir. Increasing release of cold water from either the Bucks Creek PH or Lower Bucks Lake/Bucks Creek would be beneficial primarily to the lower Rock Creek Reach, because much higher discharges from the Rock Creek Powerhouse would mute this temperature benefit once these two discharges mix in Cresta Reservoir.

Conclusion: Consider this measure.

13. Reduce warming of Rock Creek reach by increasing shading through planting of vegetation.

This measure consists of performing streamside vegetation management and planting on the Rock Creek Reach to promote shading and reduce warming. Existing shading of the Rock Creek Reach is approximately 25%. Warming in July 2002 in the Rock Creek Reach was not significant (about 0.4°C) because the release temperatures from Rock Creek Dam were high (21.3°C) and close to air temperature. Water temperature modeling indicates that, if total shading of the Rock Creek Reach was increased to 50%, warming would be reduced by about 0.5°C for the existing dam release temperature condition. Warming reduction would be more significant for lower release temperatures from Rock Creek Dam.

Conclusion: Consider this measure.

MEASURES ALONG CRESTA REACH

14. Increase release of cold water to the Cresta Reach

a. by increasing release of cold water from Cresta Dam

This measure consists of increasing releases at Cresta Dam to cool the Cresta Reach of the NFFR. Note that increasing release from Cresta Dam can only reduce warming, not reduce the water temperature at the starting point of the Cresta Reach. Water temperature modeling tests indicate that the warming reduction benefit by increasing the magnitude of water releases at Cresta Dam is more measurable if the dam release temperature is lower than 20°C (Figure 12).

Conclusion: Consider this measure.

b. by increasing release of cold water to the Cresta Reach from Grizzly Forebay/Grizzly Creek

This measure consists of increasing the cool water releases at Grizzly Forebay Dam to reduce warming in Grizzly Creek, thereby discharging more cooler water to the Cresta Reach. The water temperature of releases below Grizzly Dam in July 2002 was 14.4°C and warming from Grizzly Dam to the mouth of Grizzly Creek was about 5°C at release rate of about 6 cfs at Grizzly Dam (Note: The measured average flow near the mouth of Grizzly Creek in July 2002 was 24 cfs, indicating a flow accretion of about 18 cfs). Preliminary water temperature modeling indicates that this warming could be reduced by about 3.0°C if water releases at Grizzly Dam were increased to 100 cfs.

Conclusion: Consider this measure.

c. by constructing a bypass pipeline to convey cold Buck Creek PH flows around Cresta Reservoir to the Cresta Reach

This measure consists of constructing a new diversion structure at the Bucks Powerhouse tailrace and about four miles of water pipeline to deliver cooler water to the NFFR immediately below Cresta Dam. Based on observed average mean daily flow and water temperature data in July and August 2002 (dry year), this measure would cool water below Cresta Dam by about 1.6°C and 3.0°C in July and August, respectively.

Conclusion: Consider this measure.

d. by constructing a pipeline to convey all or a portion of the cold Buck Creek PH flows directly into Cresta Reservoir thereby avoiding mixing with Rock Creek flows thus allowing the cold Buck Creek PH flows to submerge in Cresta Reservoir for release to downstream reaches.

Unlike Belden and Rock Creek Reservoirs, Cresta Reservoir exhibits no stratification (Figure 13) because there is no cold water source to the reservoir under existing conditions. The purpose of this measure would be to develop some degree of stratification in Cresta Reservoir by conveying all or a portion of the cold Buck Creek flows directly to an appropriate plunging location at Cresta Reservoir.

Conclusion: Consider this measure.

- Enhancement measure for 14d would be to dredge a submerged channel in Cresta Reservoir

This enhancement measure consists of dredging a submerged channel in Cresta Reservoir to provide additional depth for cold water plunging and transport. This enhancement measure, in combination with measure 14d, would reduce cold water mixing with warm surface water during cold water transport through the reservoir and thereby provide

temperature reduction benefit to Rock Creek Reach. Cold water movement along a submerged channel with little mixing with warm surface water was demonstrated in the 2006 special test in Butt Valley Reservoir (2006 North Fork Feather River Special Testing Data Report, Stetson and PG&E, March 2007).

Conclusion: Consider this measure.

- ***Enhancement measure for 14d and the enhancement measure above would be to construct a low level outlet at Cresta Dam***

This enhancement measure, in combination with measure 14d and the enhancement measure above, would provide cooler water releases to the Cresta Reach. There are two level gates at Cresta Dam, one is at a depth of about 15 ft and another is at a depth of about 40 ft. The lower gate (30" diameter) has a capacity of approximately 150 cfs. At higher releases the upper gate is opened. The existing lower gate is not low enough and has insufficient capacity for higher instream flow releases. If measure 14d and the enhancement measure above were implemented, constructing a low level outlet at Cresta Dam would provide access to the cooler water in the reservoir bottom.

Conclusion: Consider this measure.

e. ***by constructing a mechanical water cooling tower or chiller below Cresta Dam***

This measure consists of constructing and operating a mechanical water cooling tower or chiller below Cresta Dam to cool incoming river water and delivering it back to the NFFR immediately downstream of the dam. The amount of water temperature reduction below Cresta Dam would depend on the amount of flow delivered to the cooling tower or chiller and the degree of cooling by the cooling tower or chiller.

Conclusion: Consider this measure.

15. Reduce warming of Cresta reach by increasing shading through planting of vegetation.

This measure consists of performing streamside vegetation management and planting on the Cresta Reach to promote shading and reduce warming. Existing shading of the Cresta Reach is approximately 30%. Warming in July 2002 in the Cresta Reach was not significant (about 0.5°C) because existing release temperatures from Rock Creek Dam were high (21.2°C) and close to air temperature. Water temperature modeling indicates that the benefit of increasing Cresta Reach shading from existing 30% to 60% would be a reduction in warming by about 0.5°C.

Conclusion: Consider this measure.

MEASURES ALONG POE REACH

16. Increase release of cold water to the Poe Reach

a. by increasing release of cold water from Poe Dam

This measure consists of re-operating Poe Dam to provide increased magnitude water releases at Poe Dam to reduce warming in the Poe Reach. The amount of reduction in warming is related to Poe Dam release water temperature and the rate of release (Figure 14).

Conclusion: Consider this measure.

b. by releasing water to the Poe Reach directly from the Poe Adit

This measure consists of constructing and operating a water pipeline to transport cool Poe Tunnel water from Poe Tunnel Adit #1 to the NFFR near Bardees Bar, located approximately 4.5 river miles below Poe Dam. This measure would provide water temperature benefits to the lower Poe Reach below Bardees Bar.

Conclusion: Consider this measure.

c. by constructing a mechanical water cooling tower or chiller below Poe Dam

This measure consists of constructing and operating a mechanical water cooling tower or chiller below Poe Dam to cool incoming river water and delivering it back to the NFFR immediately downstream of the dam. The amount of water temperature reduction below Poe Dam would depend on the amount of flow delivered to the cooling tower or chiller and the degree of cooling by the cooling tower or chiller (Figure 15).

Conclusion: Consider this measure.

17. Reduce warming of Poe reach by increasing shading through planting of vegetation.

This measure consists of performing streamside vegetation management and planting on the Poe Reach to promote shading and reduce warming. Existing shading of the Poe Reach is approximately 22%. Warming in July 2002 in the Poe Reach was about 2.1°C. Water temperature modeling indicates that increasing total shading of the Poe Reach to 50% would reduce warming by about 0.8°C. Warming reduction would be more significant for lower release temperatures from Poe Dam.

Conclusion: Consider this measure.

MEASURES ALONG ALL REACHES

18. Increase release of cold water to all reaches by discharging cold water to the reaches from water wells that are drilled into adjacent rock and intercept and produce from fractures containing large volumes of cold water.

This measure consists of drilling, constructing and operating large water wells that would tap fracture zones along the NFFR to deliver cooler well water to the river below each dam. The cooling requirement would require numerous very productive cold water wells at each dam. According to PG&E, existing geologic information and well driller's data demonstrate that it is not likely that an adequate aquifer exists near the dams. Extensive field investigation would be required to evaluate the feasibility of this measure.

Conclusion: Eliminate this measure.

19. Increase release of cold water to all reaches by discharging cold water to the reaches from a pipeline that conveys cold water pumped from Lake Oroville.

This measure consists of constructing and operating up to about 40 miles of very large diameter water pipeline and pumping stations along the NFFR to deliver cooler water from the depths of Lake Oroville to the NFFR at each dam. This measure would cool water by approximately 3°C below each dam. The cooling requirement would require a large diameter pipeline, several large pumping stations, and a substantial amount of electrical power to operate the pumping stations.

Conclusion: Consider this measure.

**Results of Evaluation of Potential Measures for Reducing Water Temperature
in the North Fork Feather River**

Alternative # in the 24 Alternatives Report	Measures	Evaluation Result
	<u>Above or At Lake Almanor</u>	
	1. Increase release of cold water from Lake Almanor	
<u>1, 2</u>	a. to Butt Valley Reservoir through closely controlled, selective withdrawal from the Prattville Intake by installing a thermal curtain or other device	Consider
<u>8</u>	b. to the Seneca Reach through selective withdrawal from the existing Canyon Dam Outlet	Eliminate
<u>5</u>	c. to Butt Valley Reservoir through reduced withdrawal from the Prattville Intake	Consider
<u>6</u>	d. to the Seneca Reach through increased cold water releases from Canyon Dam low-level outlet	Consider
<u>3</u>	- Enhancement measure for both 1a and 1b would be to dredge the lake bottom levees in the Prattville Intake area	Consider
<u>N/A</u>	- Enhancement measure for 1a to 1d would be to increase the inflow supply of cooler water into Lake Almanor (to prevent depletion of the hypolimnion).	Consider
	<ul style="list-style-type: none"> • by constructing an expansive, high-capacity wellfield that would pump directly from the basalt aquifer discharging to Big Springs/northeastern Lake Almanor. The pumped cold water could be conveyed by pipeline laid along the lakebed and connected for direct discharge into the Prattville Intake or Canyon Dam Outlet. • by connecting a conduit to the Hamilton Branch tailrace that extends out into the depths of Lake Almanor to replenish the hypolimnion with cool water. • by purchasing water rights along the UNFFR and Hamilton Branch above Lake Almanor and transferring the water rights to instream use or changing the point of diversion to below Oroville thereby causing cooler inflows into Lake Almanor by preventing the warming effect of diversions and return flows above the lake. • by reducing warming along the UNFFR and Hamilton Branch above Lake Almanor by increasing shading through planting of vegetation thereby causing cooler inflows. 	Consider Eliminate Eliminate Eliminate
<u>N/A</u>	- Enhancement measure for 1a to 1d would be to raise the elevation of the dam/spillway and/or seasonal operating levels of the lake to raise the level of the top of the hypolimnion and increase its overall volume.	Eliminate
	<u>At Butt Valley</u>	
	2. Increase release of cold water from Butt Valley Reservoir	
<u>7</u>	a. to Belden Reservoir through preferential use of Caribou PH #1	Consider
<u>N/A</u>	b. to Lower Butt Creek through releases from a new low level Butt Valley Dam Outlet	Eliminate

<u>N/A</u>	c.	to Belden Reservoir by directly conveying Butt Valley PH discharge to Caribou No.2 and/or Caribou No.1.	Consider
<u>N/A</u>	-	Enhancement measure for 3a would be to construct a “crossover” conduit connecting Caribou No. 1 to Caribou No. 2.	Consider
<u>4</u>	-	Enhancement measure for both 3a and 3b would be to install a thermal curtain across Butt Valley Reservoir near the Caribou Intakes.	Consider
<u>N/A</u>	-	Enhancement measure for both 3a and 3b would be to raise the elevation of the dam/spillway and/or seasonal operating levels of the reservoir to raise the top of the hypolimnion and its overall volume.	Eliminate
<u>Along Seneca Reach</u>			
<u>N/A</u>	3.	Reduce warming along the Seneca Reach by increasing shading through planting of vegetation.	Eliminate
<u>Along Belden Reach</u>			
	4.	Increase release of cold water to the Belden Reach	
<u>9</u>	a.	by increasing release of cold water from Belden Dam Outlet/Oak Flat PH	Consider
<u>18</u>	b.	by constructing a bypass pipeline to convey cold Seneca Reach flows around Belden Reservoir to the Belden Reach.	Consider
<u>N/A</u>	c.	by operating Caribou PH in strict peaking mode with several hours shut down time to prevent mixing at the Caribou PH/Seneca confluence and thereby allow cold Seneca Reach flows (enhanced by increasing Canyon Dam releases to the Seneca Reach) to submerge in Belden Reservoir for release to downstream reaches.	Consider
<u>N/A</u>	d.	by constructing a pipeline to convey cold Seneca Reach flows (enhanced by increasing Canyon Dam releases to the Seneca Reach) to an appropriate plunging location in Belden Reservoir.	Consider
<u>N/A</u>	e.	by constructing a mechanical water cooling tower or chiller at a site	
<u>14, 15</u>	-	below Belden Dam	Consider
<u>14, 15</u>	-	at the Belden Adit	Consider
<u>N/A</u>	5.	Reduce warming along the lower Belden Reach by constructing a bypass pipeline to convey warm East Branch flows directly into Rock Creek Reservoir, bypassing the lower Belden Reach.	Consider
<u>N/A</u>	6.	Reduce warming of Belden reach by increasing shading through planting of vegetation.	Eliminate
<u>23</u>	7.	Reduce warming along the East Branch by increasing shading through planting of vegetation.	Consider
	8.	Replace discharge of warm water into the UNFFR from the East Branch with cooler water by collecting and discharging thermally stratified cold water to the NFFR	
<u>21</u>	a.	by constructing a new reservoir on the upper East Branch	Eliminate
<u>22</u>	b.	by enlarging the existing reservoir on the upper East Branch	Eliminate
<u>N/A</u>	9.	Replace discharge of warm water into the UNFFR from the East Branch with cooler water by purchasing water rights and transferring the water rights to instream use or changing the point of diversion to below Oroville thereby causing cooler inflows into the UNFFR by preventing the warming	Eliminate

effect of diversions and return flows along the East Branch above the confluence.

- | | | | |
|------------|-----|---|-----------|
| <u>N/A</u> | 10. | Reduce temperature of East Branch inflows to the NFFR by stream channel restoration efforts in the upper East Branch watershed. | Eliminate |
|------------|-----|---|-----------|

Along Rock Creek Reach

- | | | | |
|--------------|-----|--|-----------|
| | 11. | Increase release of cold water to the Rock Creek Reach | |
| <u>10</u> | a. | by increasing release of cold water from Rock Creek Dam | Consider |
| <u>21</u> | b. | by constructing a new reservoir on the upper Yellow Creek to collect and discharge thermally stratified cold water to the UNFFR/Rock Creek Reservoir. | Eliminate |
| <u>19</u> | c. | by constructing a bypass pipeline to convey cold Yellow Creek/Chips Creek flows around Rock Creek Reservoir to the Rock Creek Reach | Consider |
| <u>14,15</u> | d. | by constructing a mechanical water cooling tower or chiller at the site of PG&E's Rogers Flat Station for discharge to the Rock Creek Reach | Consider |
| <u>N/A</u> | e. | by constructing a bifurcation berm/wall/partition within Yellow Creek channel and upstream of Rock Creek Reservoir to separate Yellow Creek flows from Belden PH discharges and Belden Reach flows, thereby preventing mixing and thus allowing cooler Yellow Creek flows to submerge in Rock Creek Reservoir for release to downstream reaches. | Consider |
| <u>N/A</u> | f. | by constructing a bypass pipeline to convey cold Yellow Creek flows directly to an appropriate plunging location in Rock Creek Reservoir | Consider |
| <u>N/A</u> | - | Enhancement measure for 11e would be to dredge a submerged channel in Rock Creek Reservoir. | Consider |
| <u>N/A</u> | - | Enhancement measure for 11e or 11f and the enhancement measure above would be to construct a low level outlet at Rock Creek Dam. | Consider |
| <u>13</u> | 12. | Increase release of cold water to the lower Rock Creek Reach by increasing release of cold water to the Rock Creek Reach from Lower Bucks Lake/Bucks Creek. | Consider |
| <u>N/A</u> | 13. | Reduce warming of Rock Creek reach by increasing shading through planting of vegetation. | Consider |

Along Cresta Reach

- | | | | |
|---------------|-----|--|----------|
| | 14. | Increase release of cold water to the Cresta Reach | |
| <u>11</u> | a. | by increasing release of cold water from Cresta Dam | Consider |
| <u>N/A</u> | b. | by increasing release of cold water to the Cresta Reach from Grizzly Forebay/Grizzly Creek | Consider |
| <u>20</u> | c. | by constructing a bypass pipeline to convey cold Buck Creek PH flows around Cresta Reservoir to the Cresta Reach | Consider |
| <u>N/A</u> | d. | by constructing a pipeline to convey all or a portion of the cold Buck Creek PH flows directly into Cresta Reservoir thereby avoiding mixing with Rock Creek flows thus allowing the cold Buck Creek PH flows to submerge in Cresta Reservoir for release to downstream reaches. | Consider |
| <u>N/A</u> | - | Enhancement measure for 14d would be to construct a submerged channel in Cresta Reservoir | Consider |
| <u>N/A</u> | - | Enhancement measure for 14d and the enhancement measure above would be to construct a low level outlet at Cresta Dam | Consider |
| <u>14, 15</u> | e. | by constructing a mechanical water cooling tower or chiller below Cresta | Consider |

		Dam	
<u>N/A</u>	15.	Reduce warming of Cresta reach by increasing shading by planting veg..	Consider
		<u>Along Poe Reach</u>	
	16.	Increase release of cold water to the Poe Reach	Consider
<u>12</u>	a.	by increasing release of cold water from Poe Dam	Consider
<u>24</u>	b.	by releasing water to the Poe Reach directly from the Poe Adit	Consider
<u>14, 15</u>	c.	by constructing a mechanical water cooling tower or chiller below Poe Dam	Consider
<u>N/A</u>	17.	Reduce warming of Poe reach by increasing shading through planting of vegetation.	Consider
		<u>Along All Reaches</u>	
<u>16</u>	18.	Increase release of cold water to all reaches by discharging cold water to the reaches from water wells that are drilled into adjacent rock and intercept and produce from fractures containing large volumes of cold water.	Eliminate
<u>17</u>	19.	Increase release of cold water to all reaches by discharging cold water to the reaches from a pipeline that conveys cold water pumped from Lake Oroville.	Consider

Table 1 Summary of Observed Mean Daily Water Temperatures during July 2003 Caribou Special Test

Date	Caribou No. 1		Caribou No. 2		Resultant Caribou Blend *	Belden Forebay (BD1) (°C)	NFFR below Belden Dam (NF5) (°C)	NFFR above EBNFFR (NF7) (°C)	EBNFFR above NFFR (EB1) (°C)	NFFR above Belden PH (NF8) (°C)	Remarks
	Temperature (°C)	Flow (cfs)	Temperature (°C)	Flow (cfs)							
	07/12/03	---	9	20.1							
07/13/03	---	7	20.0	1172	20.0	19.8	19.0	18.9	22.4	20.7	Part 1
07/14/03	---	0	20.2	1214	20.2	19.8	19.2	19.1	22.3	20.7	Part 1
07/15/03	---	14	20.5	1270	20.5	20.1	19.4	19.3	22.5	20.9	Part 1
07/16/03	---	57	20.6	1191	20.6	20.2	19.4	19.4	22.7	21.1	Part 1
07/17/03	---	66	21.0	1250	21.0	20.3	19.6	19.5	22.8	21.1	Part 1
07/18/03	16.4	893	---	67	16.4	19.1	18.3	19.1	23.2	21.3	Part 2
07/19/03	16.8	940	---	21	16.8	17.5	17.2	18.6	23.8	21.2	Part 2
07/20/03	17.0	994	---	12	17.0	17.3	17.1	18.5	24.4	21.4	Part 2
07/21/03	17.5	996	---	0	17.5	17.6	17.2	18.8	25.4	22.0	Part 2
07/22/03	17.8	996	---	0	17.8	17.8	17.4	19.0	25.8	22.1	Part 2
07/23/03	18.0	997	---	9	18.0	18.1	17.6	19.0	26.4	22.3	Part 2
07/24/03	18.4	992	---	3	18.4	18.4	17.8	19.0	25.8	22.0	Part 2
07/25/03	18.4	564	---	3	18.4	19.8	18.1	19.0	25.1	21.8	Part 2
07/26/03	18.4	628	23.0	897	21.1	20.9	18.5	19.1	24.7	21.6	Part 3
07/27/03	18.8	495	23.0	1001	21.6	21.3	19.4	19.6	24.5	21.7	Part 3
07/28/03	19.1	495	23.0	842	21.5	21.4	20.0	20.4	24.9	22.4	Part 3
07/29/03	19.0	552	23.4	904	21.7	21.5	20.1	20.6	25.4	22.9	Part 3
07/30/03	19.1	460	23.2	874	21.8	21.7	20.5	20.7	25.6	23.0	Part 3

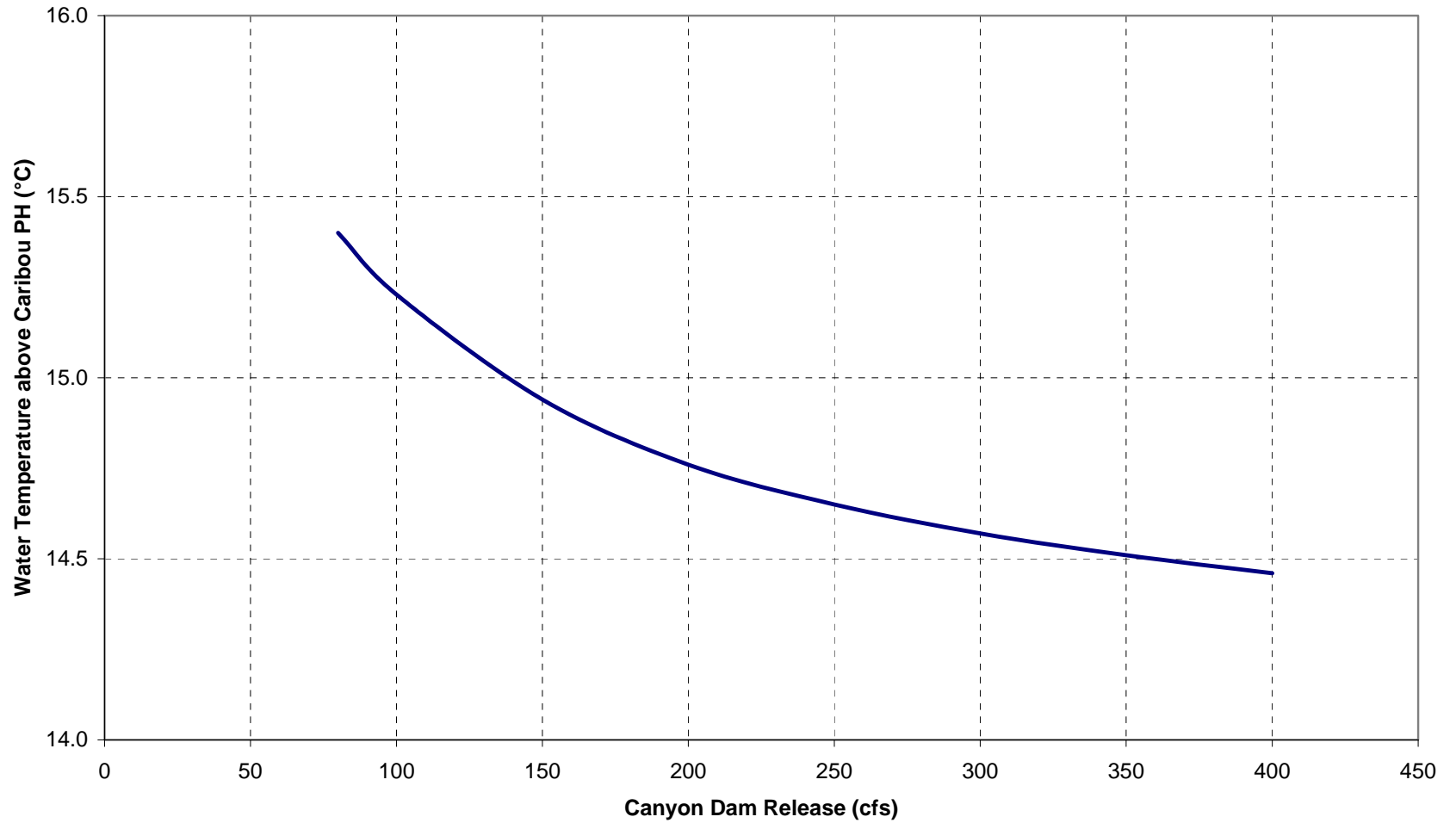
* Based on mass balance calculations.

Table 1 Summary of Observed Water Temperatures during July 2003 Caribou Special Test (Continued)

Date	Belden PH		NFFR below Rock Creek Dam (NF9) (°C)	NFFR above Bucks Creek (NF12) (°C)	NFFR above Rock Creek PH (NF13) (°C)	NFFR below Cresta Dam (NF14) (°C)	NFFR above Cresta PH (NF16) (°C)	NFFR below Poe Dam (°C)	Remarks
	Temperature (°C)	Flow (cfs)							
	07/12/03	19.6	984	19.8	20.1	18.2	19.4	19.8	
07/13/03	19.8	1086	19.9	20.2	18.2	19.5	20.0	19.9	Part 1
07/14/03	19.8	1172	19.8	20.0	18.1	19.6	19.9	19.9	Part 1
07/15/03	20.1	1140	20.1	20.3	18.3	19.7	20.1	19.9	Part 1
07/16/03	20.2	1221	20.2	20.5	18.4	19.9	20.2	20.2	Part 1
07/17/03	20.3	1199	20.2	20.5	18.4	19.9	20.3	20.3	Part 1
07/18/03	19.5	900	20.4	20.7	18.5	20.0	20.4	20.3	Part 2
07/19/03	17.8	913	19.7	21.1	18.8	20.2	20.8	20.5	Part 2
07/20/03	17.4	903	19.1	21.0	18.7	19.6	20.6	20.2	Part 2
07/21/03	17.6	957	19.3	21.3	19.0	19.6	20.9	20.0	Part 2
07/22/03	17.9	962	19.6	21.5	19.2	19.8	21.0	20.1	Part 2
07/23/03	18.2	944	19.9	21.7	19.3	20.1	21.2	20.4	Part 2
07/24/03	18.4	932	19.8	21.4	19.1	20.1	21.2	20.5	Part 2
07/25/03	19.5	1352	19.9	21.1	18.8	19.9	21.0	20.3	Part 2
07/26/03	20.8	1441	20.7	21.1	18.8	20.1	20.5	20.4	Part 3
07/27/03	21.3	1323	21.2	21.2	19.8	20.6	21.0	20.8	Part 3
07/28/03	21.4	1318	21.5	21.8	20.5	21.4	21.7	21.4	Part 3
07/29/03	21.5	1413	21.7	22.4	22.3	21.7	22.2	22.0	Part 3
07/30/03	21.7	1361	22.0	22.7	23.0	22.1	22.7	22.4	Part 3

Figure 1 Estimated Water Temperatures of Seneca Reach above Caribou PH with Different Canyon Dam Releases (Release Temperature = 13°C)

(Data Used: July 2002 Meteorology Data at Prattville Intake and Observed Average Flow and Temperature at Lower Butt Creek Mouth)



**Figure 2 Estimated Water Temperature at Butt Valley PH for a Range of Groundwater Diversions at Prattville Intake
(Groundwater Temperature = 8°C)**

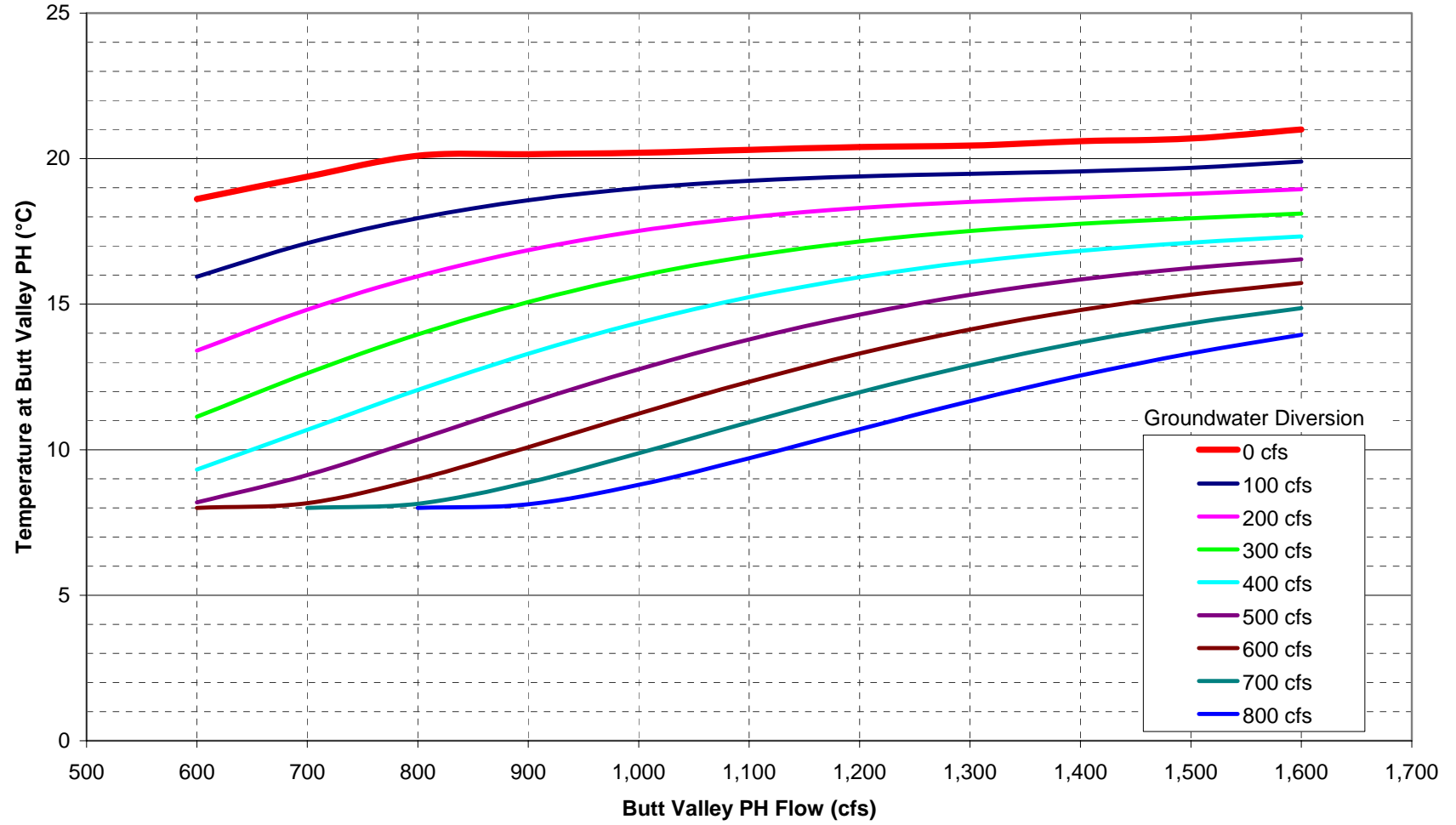


Figure 3 Observed Mean Daily Temperatures along NFFR during July 2003 Caribou Special Test

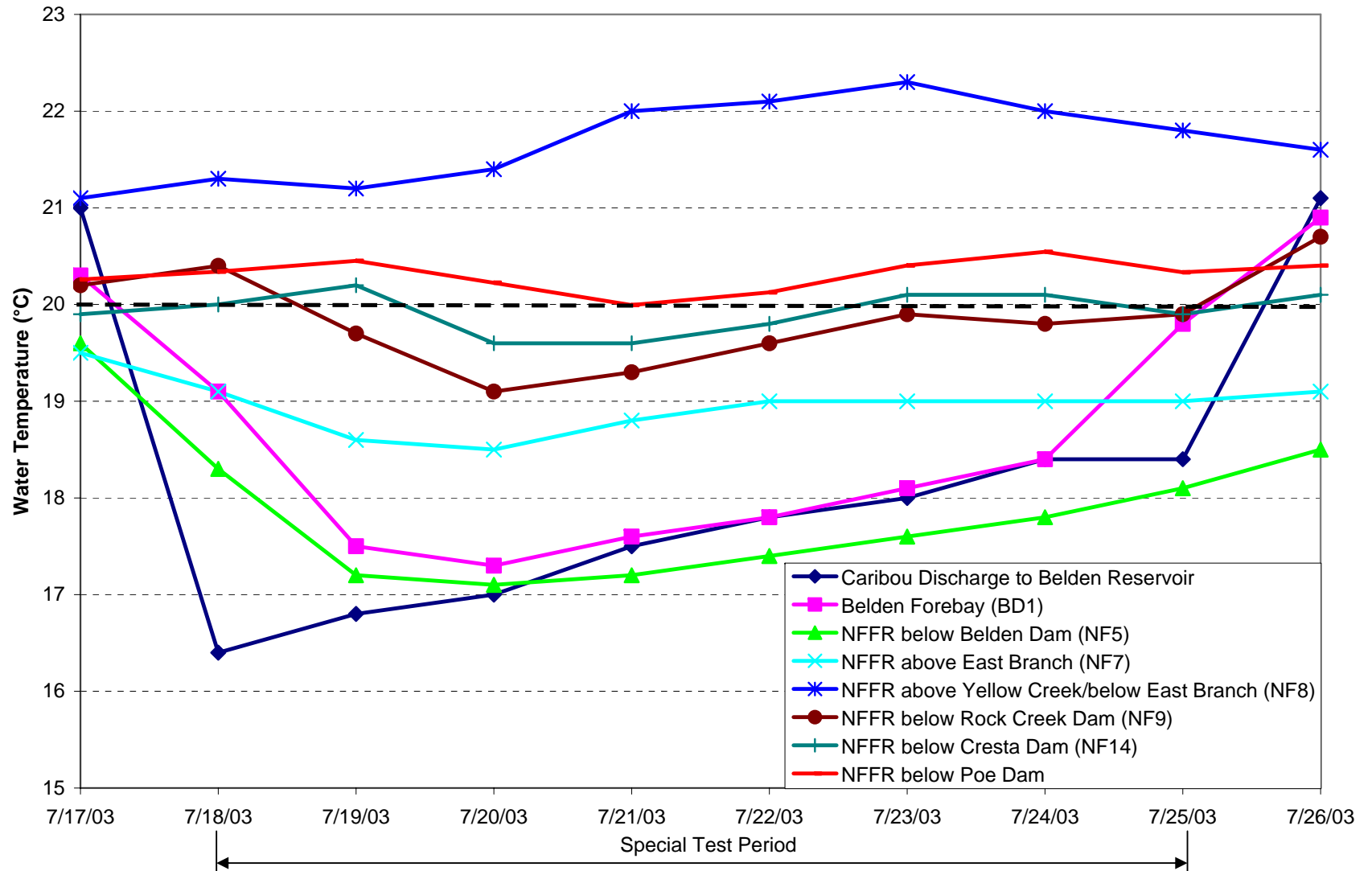


Figure 4 Simulated July 2002 Mean Daily Water Temperatures of Belden Reach above EBNFFR Confluence for a Range of Dam Releases and Release Temperatures

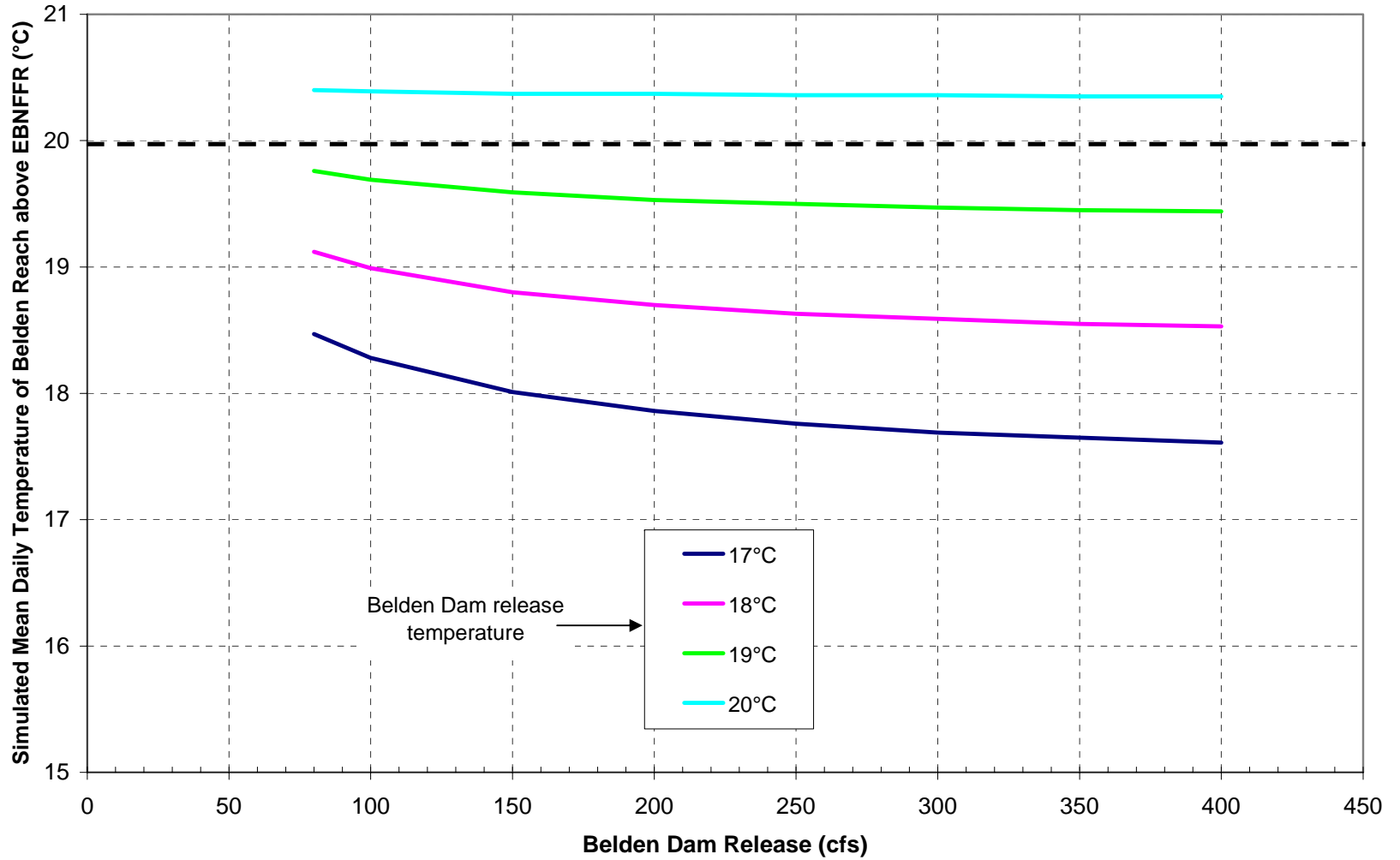
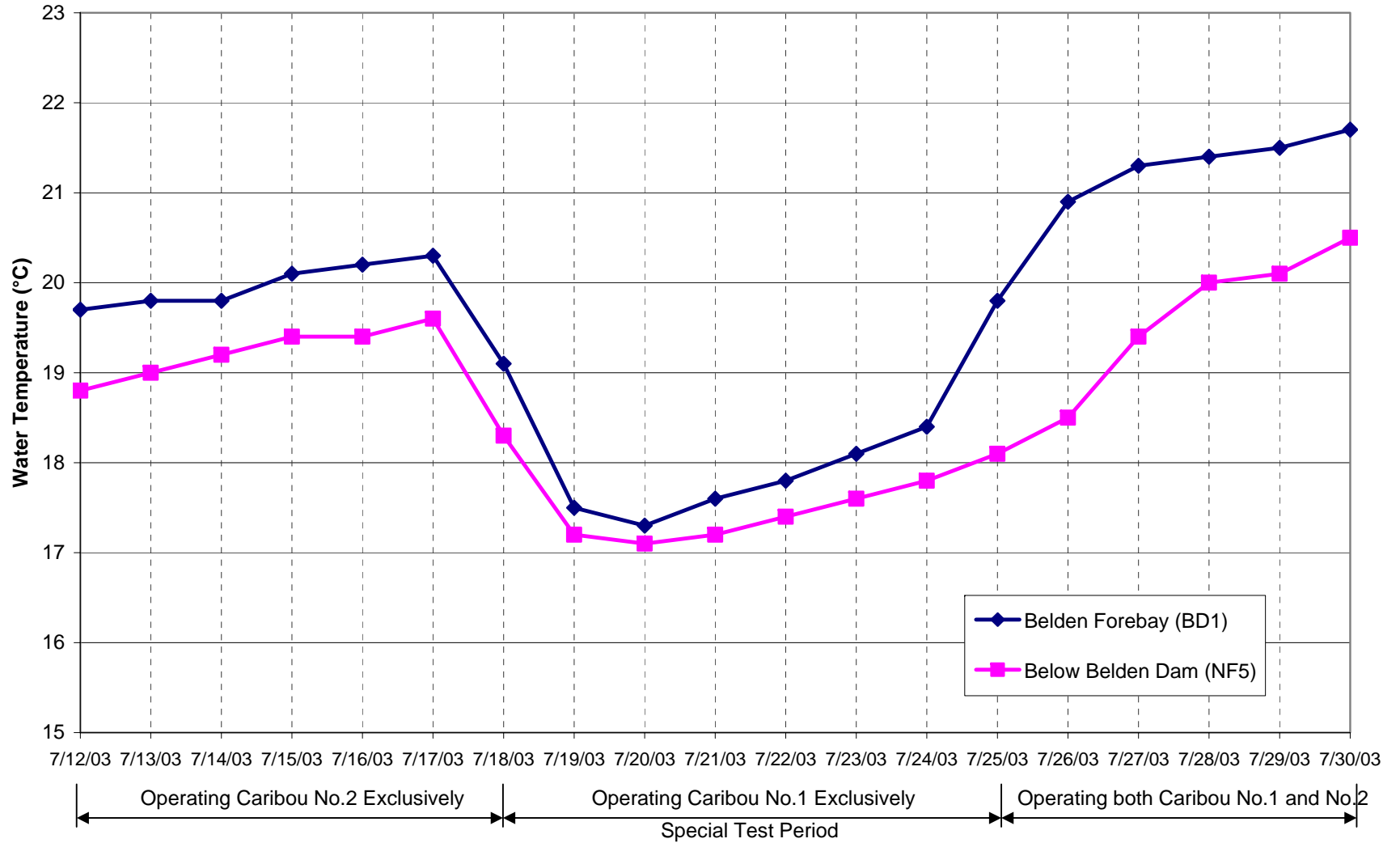


Figure 5 Observed Mean Daily Temperatures Indicating Possible Belden Reservoir Stratification during July 2003 Caribou Special Test



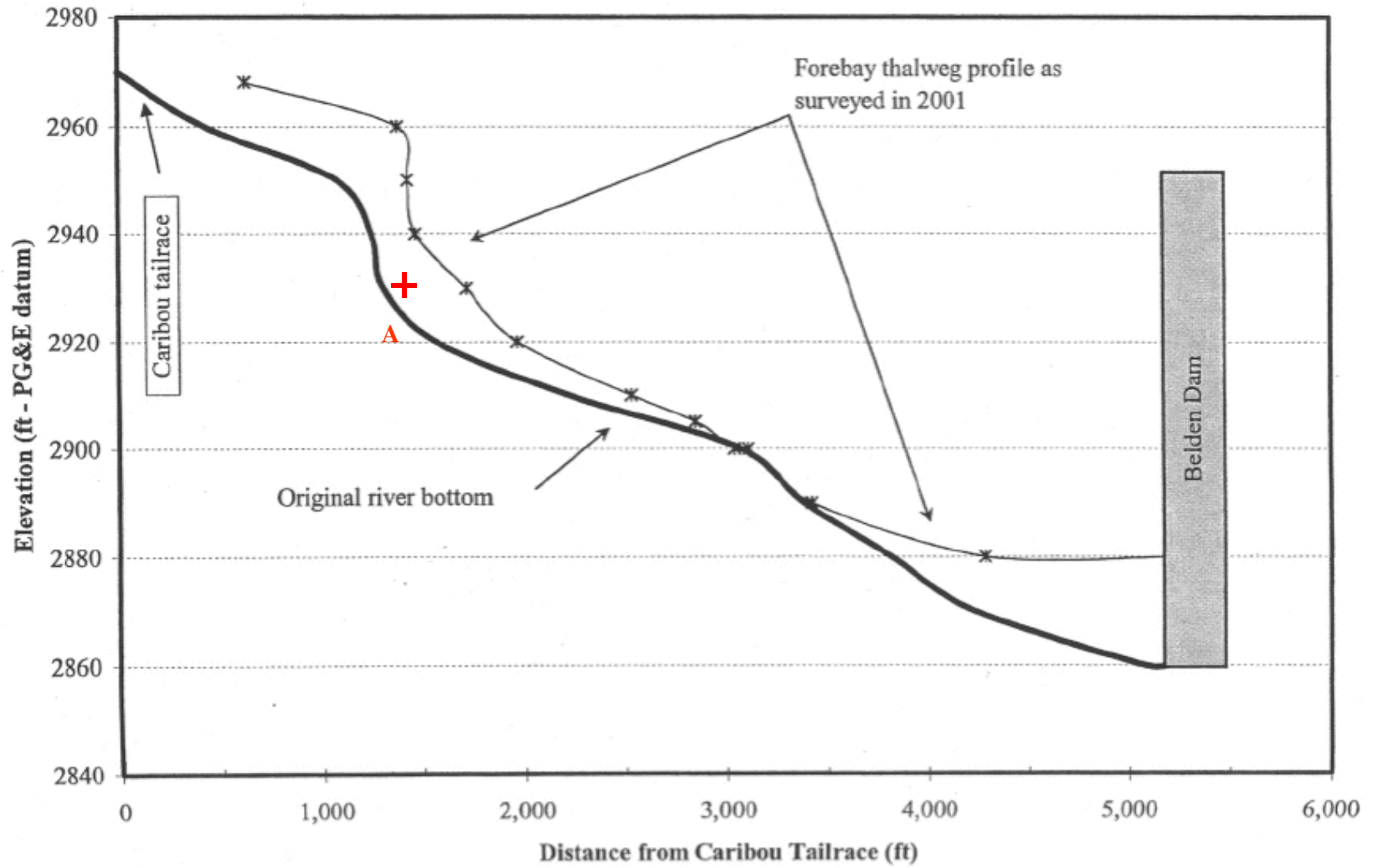


Figure 6 Possible Plunging Location (Location A) at Belden Reservoir for Cold Seneca Reach Flows

Figure 7 Water Temperature Reduction below Belden Dam for Different Flows through Mechanical Cooling Tower or Chiller and Different Degrees of Cooling
(Assumption: July Required Release in Dry Year = 130 cfs; Inflow Temperature = 19.4°C)

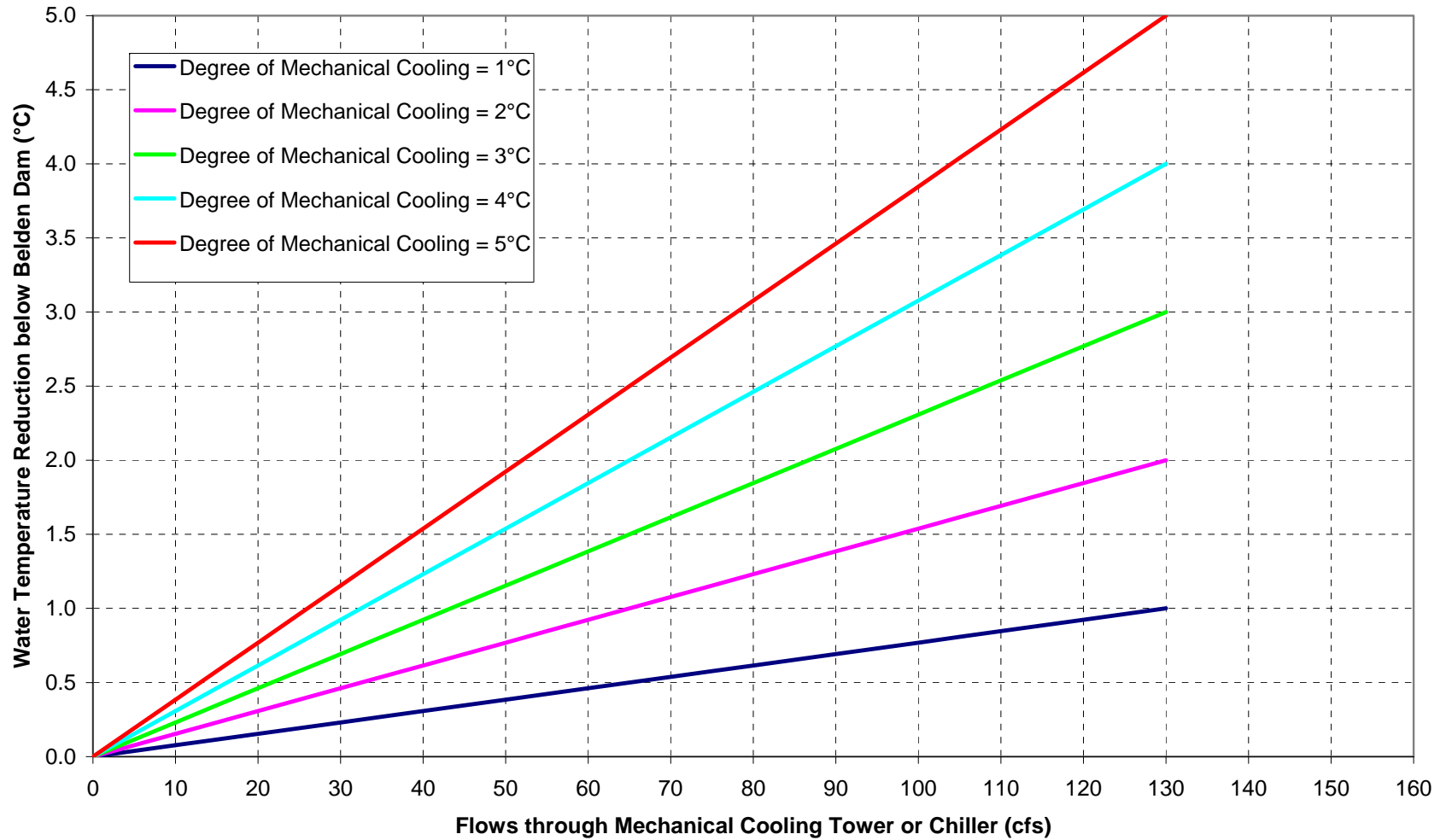


Figure 8 Simulated July 2022 Mean Daily Water Temperatures of Rock Creek Reach above Bucks Creek Confluence for a Range of Dam Releases and Release Temperatures

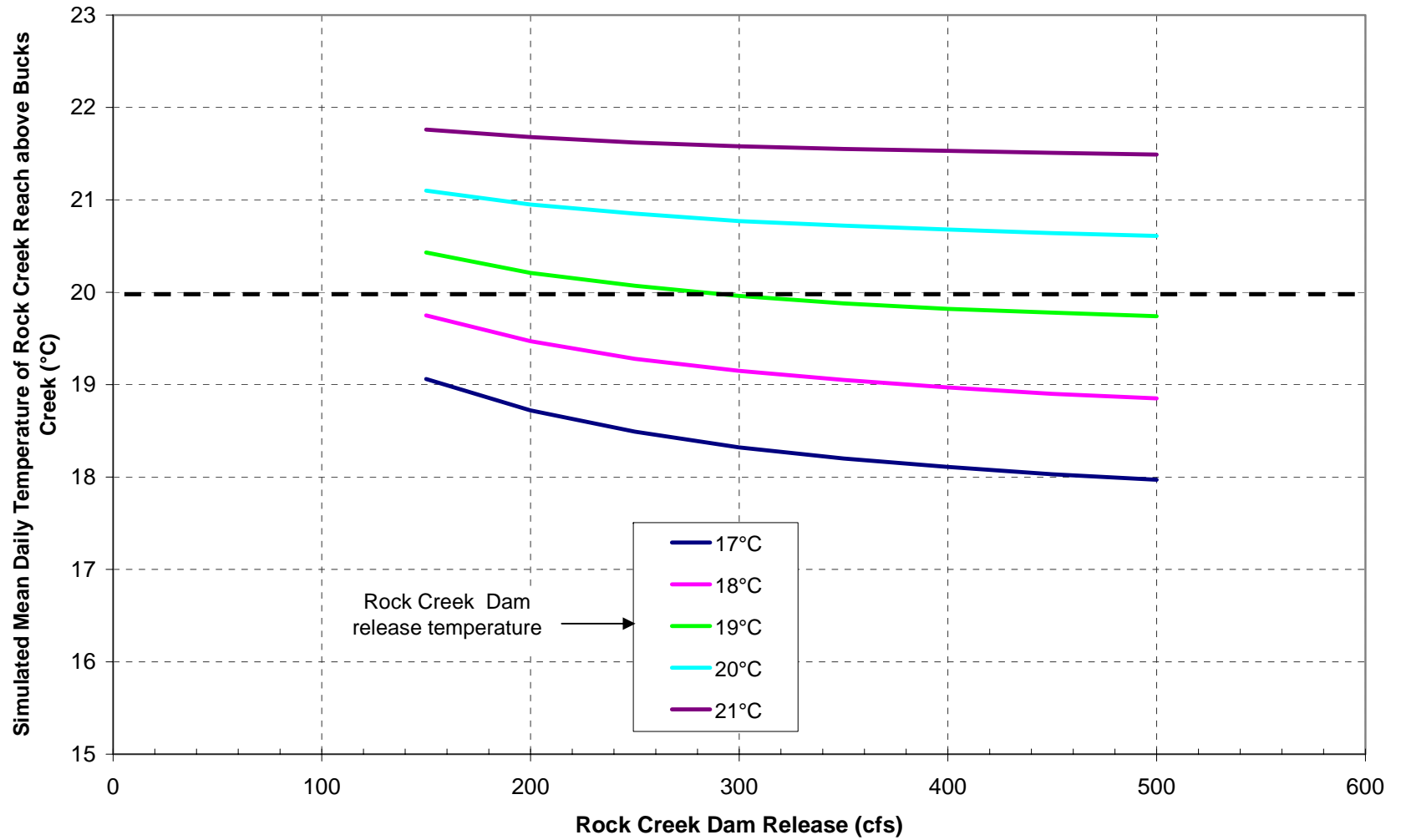


Figure 9 Water Temperature Reduction below Rock Creek Dam for Different Flows through Mechanical Cooling Tower or Chiller and Different Degrees of Cooling
(Assumption: July Required Release in Dry Year = 150 cfs; Inflow Temperature = 21.3°C)

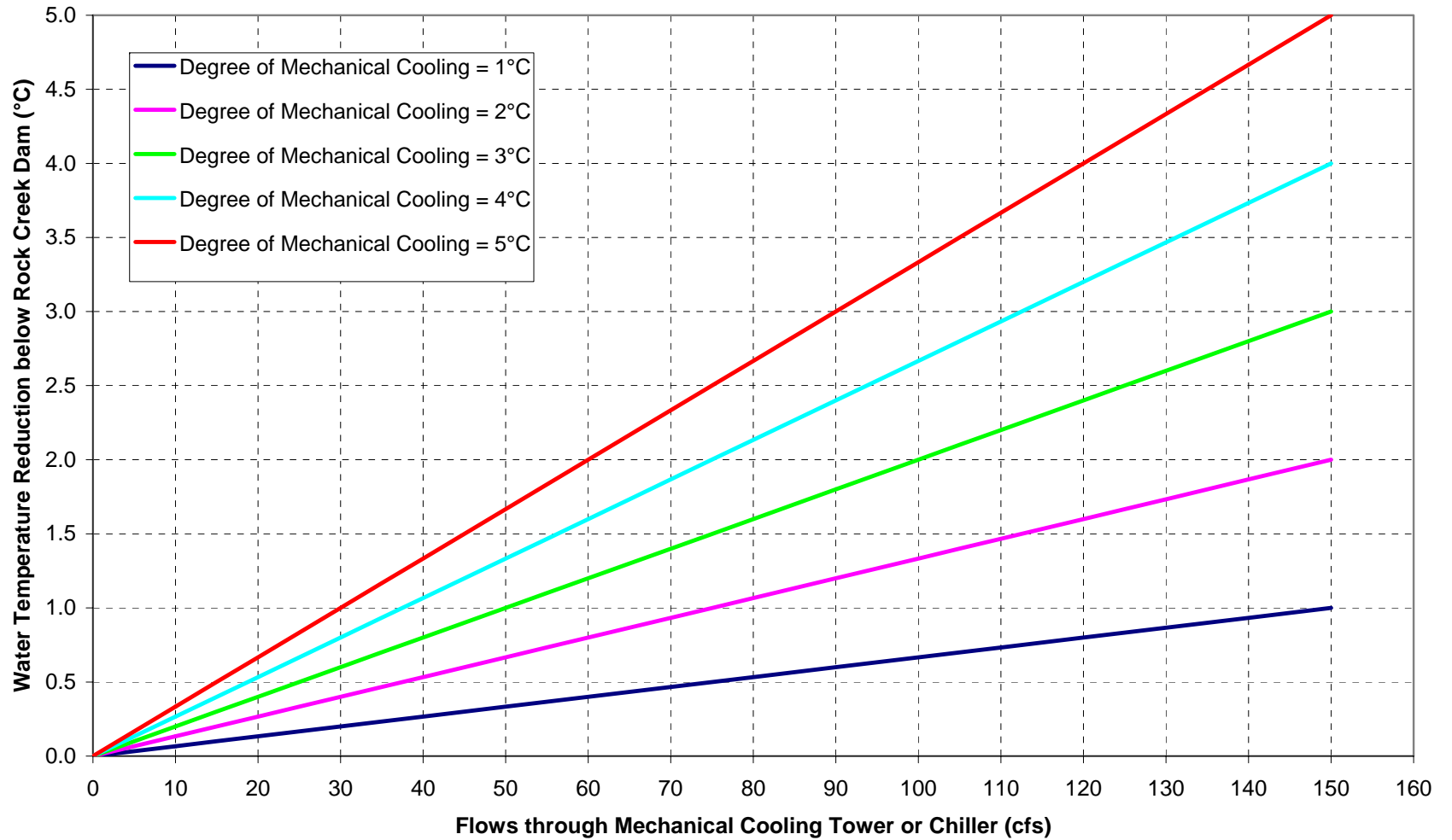
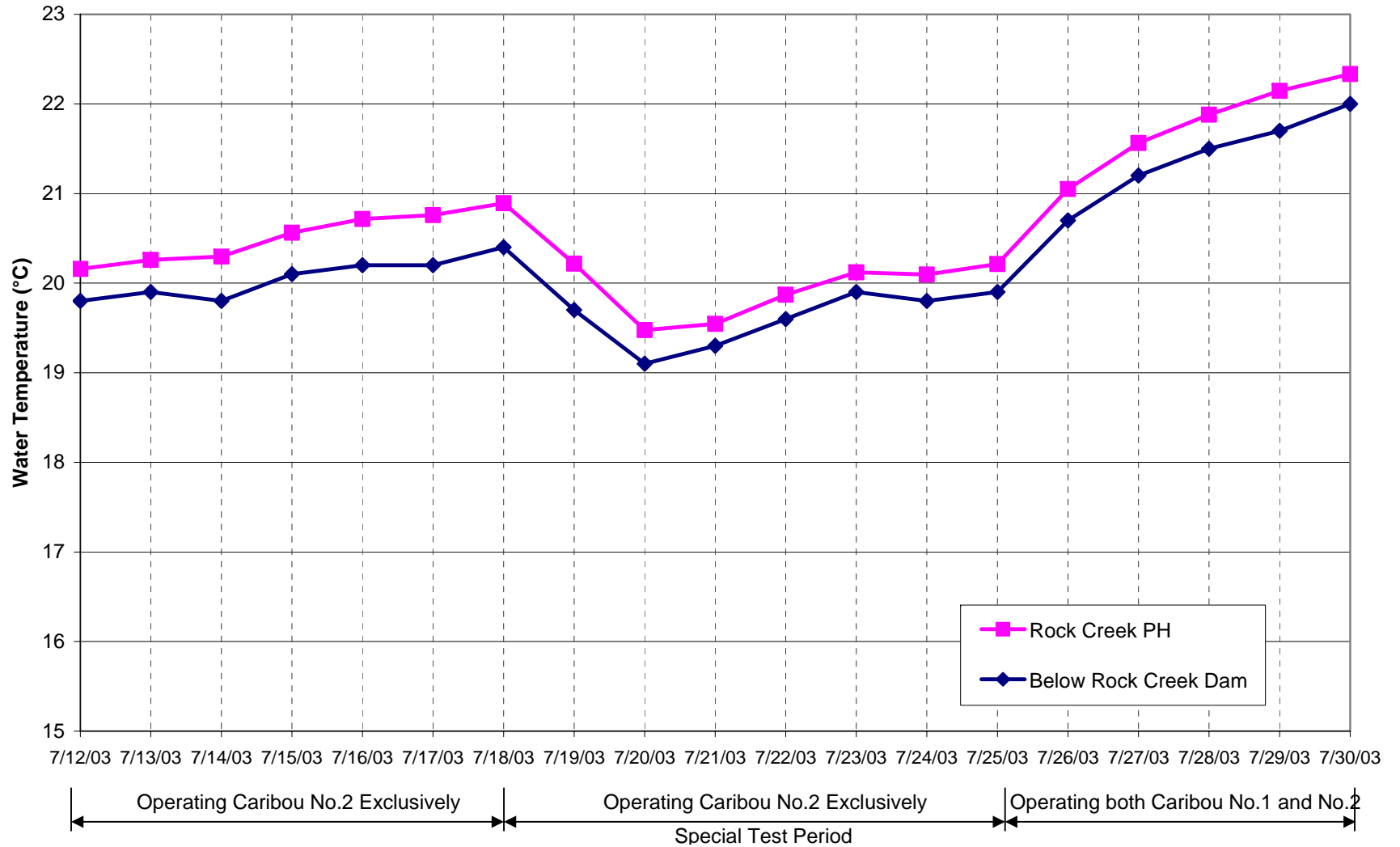


Figure 10 Observed Mean Daily Temperatures Indicating Possible Rock Creek Reservoir Stratification during July 2003 Caribou Special Test



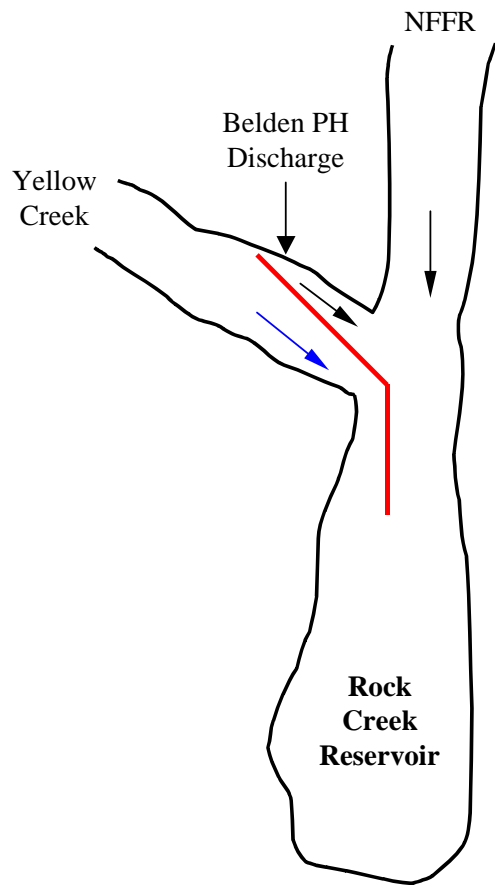


Figure 11 Schematic of Yellow Creek/Belden Powerhouse Bifurcation Berm/Wall/Partition

Figure 12 Simulated July 2022 Mean Daily Water Temperatures of Cresta Reach above Cresta PH for a Range of Dam Releases and Release Temperatures

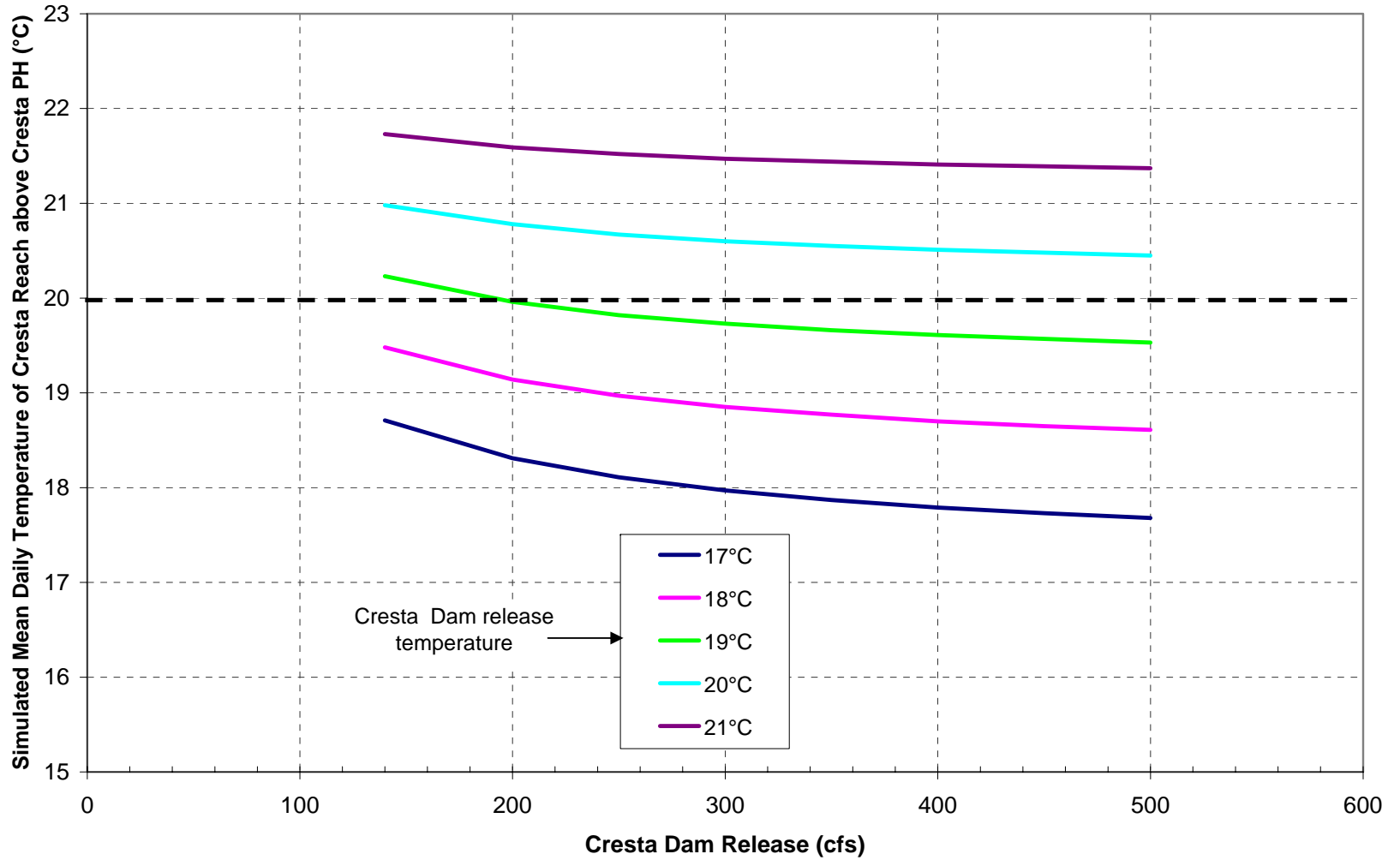


Figure 13 Observed Mean Daily Temperatures Indicating No Possible Cresta Reservoir Stratification during July 2003 Caribou Special Test

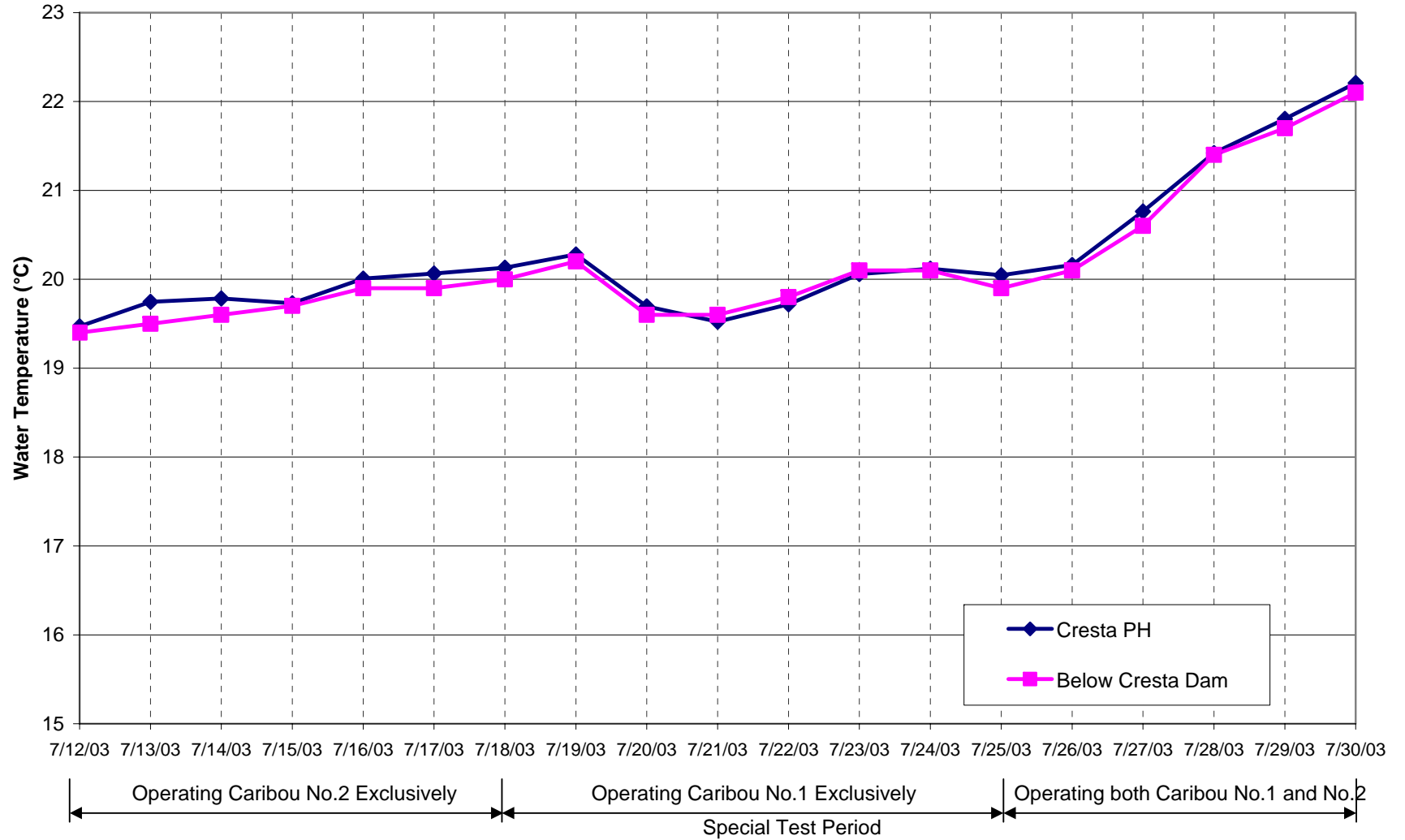


Figure 14 Simulated July 2002 Mean Daily Water Temperatures of Poe Reach above Poe PH for a Range of Dam Releases and Release Temperatures

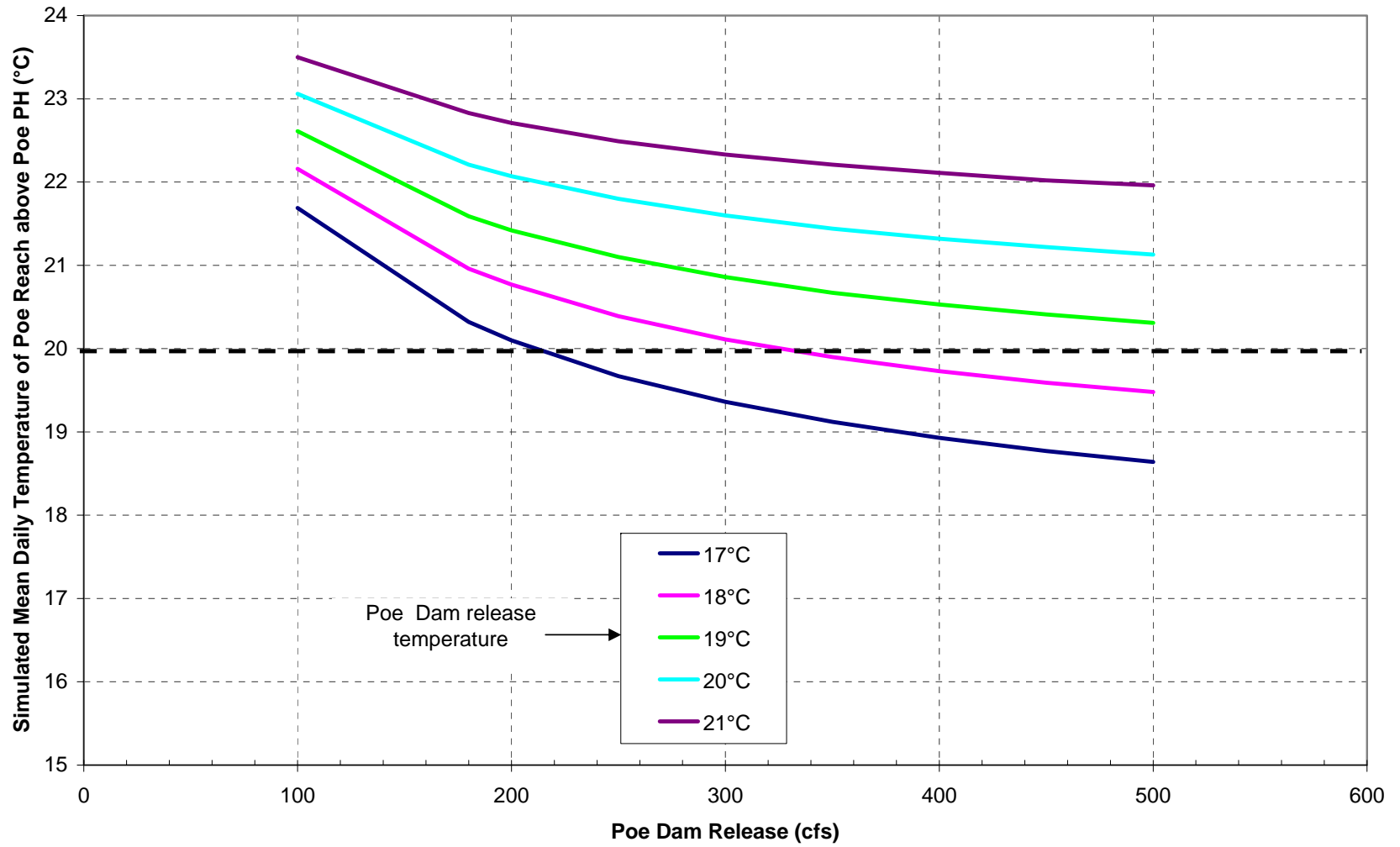
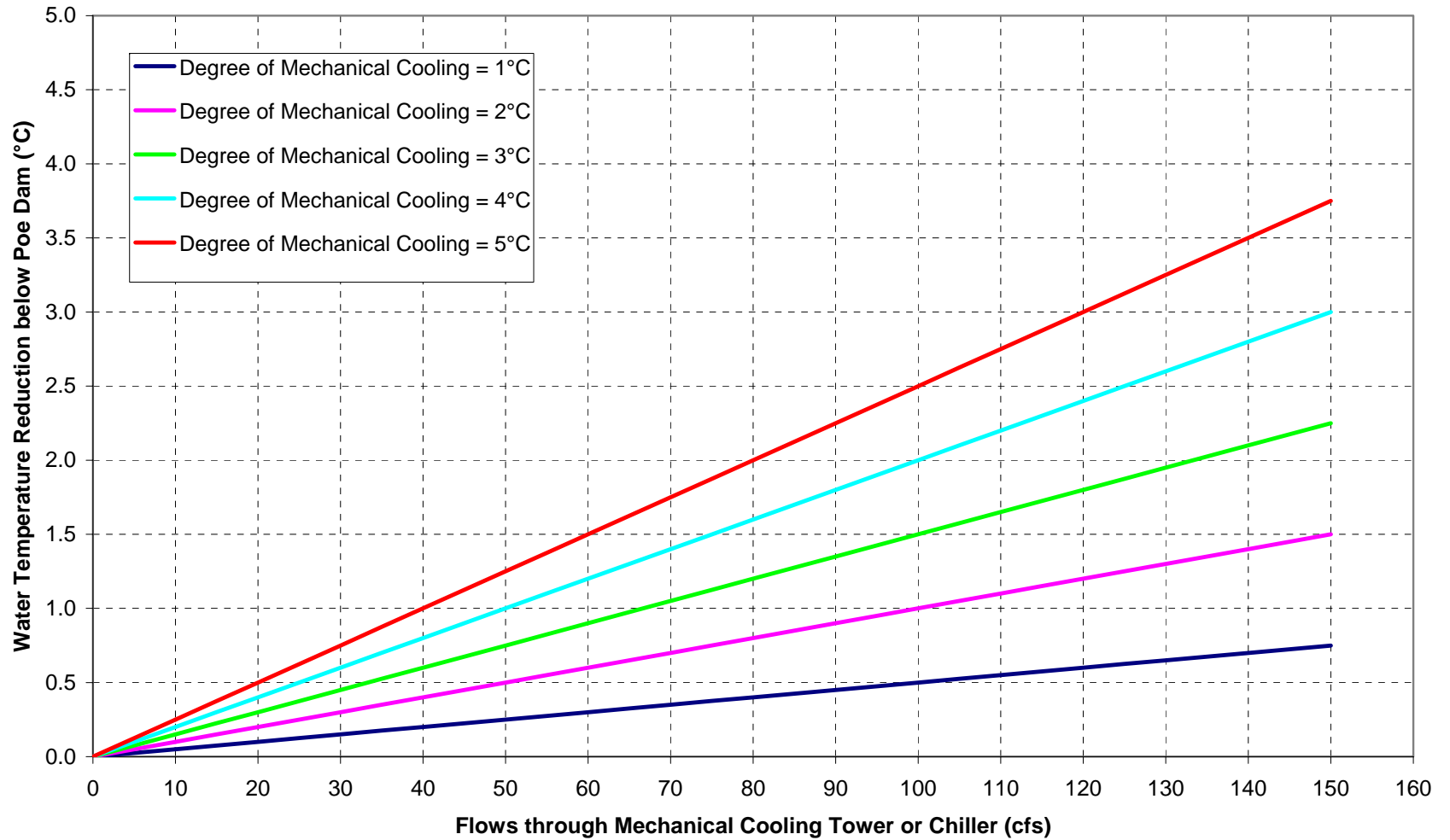


Figure 15 Water Temperature Reduction below Poe Dam for Different Flows through Mechanical Cooling Tower or Chiller and Different Degrees of Cooling
(Assumption: July Required Release in Dry Year = 200 cfs; Inflow Temperature = 21.6°C)



BOARD OF SUPERVISORS



BILL POWERS, DISTRICT 1
ROBERT A. MEACHER, DISTRICT 2
WILLIAM N. DENNISON, DISTRICT 3
ROSE COMSTOCK, DISTRICT 4
OLE OLSEN, DISTRICT 5

October 17, 2005

Sharon Stohrer
State Water Resources Control Board
1001 I Street, 14th Floor
Sacramento, CA 95814

Dear Sharon:

Please accept this letter and the enclosed documents as the comments of Plumas County regarding the scope and content of the EIR for the water quality certification for the Upper North Fork Feather River Hydroelectric Project (FERC Project 2105).

As you know, Plumas County has been an active participant in the 2105 relicensing process and is one of the parties to the partial settlement agreement that was signed last year. The settlement agreement reflects collaboration and compromise on a number of important issues – protecting and enhancing all of the designated beneficial uses of Lake Almanor, while also improving conditions in the North Fork of the Feather River below the lake. In developing and analyzing alternatives for the EIR, we request that the State Board recognize and preserve the progress of the settlement agreement to the greatest extent possible.

We recognize that water temperature in the North Fork is an important question in this relicensing and that it was not resolved in the settlement agreement. Plumas County has vocally opposed earlier proposals for a “thermal curtain” at Prattville that would attempt to siphon cold water from Lake Almanor, and we continue to be concerned with proposals for cold water releases from Canyon Dam that could alter the lake’s ecosystem. After years of negotiation and scrutiny, we are convinced that the most practical approach to addressing the impacts of Project 2105 in the Seneca and Belden reaches is to make compensating improvements elsewhere in the North Fork system.

It may be possible to make marginal temperature improvements in the North Fork below Canyon Dam, but only by jeopardizing Lake Almanor and Butt Valley Reservoir and imposing significant reductions in power generation. However, Pacific Gas & Electric Company should not be given a pass on reasonable mitigation efforts. PG&E should contribute to watershed restoration and enhancement – but in areas where the investment will provide the greatest return. That is the reason Plumas County has advanced the Watershed Restoration and Improvement Alternative focused on the East Branch of the North Fork. We hope the State Board will embrace that alternative as the primary and preferred alternative in the EIR.

Sharon Stohrer
October 17, 2005
Page Two

Finally, at the scoping meeting in Chester on September 27, we were informed the State Board could take up to two years to complete this EIR. We hope the EIR will be finished much sooner than that, considering that the original 2105 license expired a year ago and that with each passing year we postpone important environmental, recreational, and economic enhancements that have already been agreed upon as elements of the final license. Following the intentions of the CEQA guidelines and federal regulations, we request that the State Board adopt a one-year timetable to complete the EIR and make every effort to stick to that timetable.

Thank you for your consideration of our comments. Plumas County looks forward to continuing our collaborative relationship as we all move forward with this process.

Sincerely,

A handwritten signature in cursive script that reads "William N. Dennison".

William N. Dennison
Chair, Board of Supervisors



County of Plumas

Project 2105 EIR Scoping Comments

The County of Plumas appreciates the opportunity to provide scoping comments to the State Water Resources Control Board (SWRCB) for the EIR on the water quality certification for the Upper North Fork Feather River Hydroelectric Project (FERC Project 2105). Our primary concerns relate to the contemplated thermal curtains at Prattville and in Butt Valley Reservoir and the EIR's full consideration of the alternative we propose for watershed restoration efforts.

Plumas County strongly opposes the thermal curtain. For the reasons stated below, and based on the many more arguments presented at the September 27 scoping meeting, the SWRCB should determine that the thermal curtain alternative is fundamentally flawed and it should be described in the EIR as an unreasonable alternative and eliminated from further consideration. Instead, Plumas County proposes a Watershed Restoration and Improvement Alternative ("Watershed Alternative") to provide compensatory mitigation in other parts of the North Fork system, as set forth in Attachment 2. The County has reviewed available information for other alternatives and believes that the Watershed Alternative is superior to other alternatives presented. We hope that the SWRCB will arrive at the same conclusion after thoroughly evaluating the Watershed Alternative as part of the EIR.

The County appreciates the SWRCB's commitment to conduct a detailed evaluation of all the reasonable alternatives. We support an independent analysis, but wish to express concern over the potential schedule. At the scoping meeting attendees were informed that the EIR process could take as long as two years. Plumas County would like to remind the SWRCB that CEQA guidelines suggest that the EIR should be completed within one year. Also, according to federal regulations, the 401 Water Quality Certification decision must be made within one year of submittal of a complete application. This would imply that the EIR process should be completed prior to the September 2006 anniversary date of PG&E's submittal of a complete 401 application. Delaying the 401 decision beyond next September would cause further harm to the County as the County already has had to endure a two-year delay for environmental, recreational, and economic improvements agreed to in the April 2004 Settlement Agreement.

Finally, it is important that the EIR recognize the efforts and progress of the relicensing processes to date. Collaborative groups have been wrestling with the North Fork water management questions for years, and the products of their collective efforts are the settlement agreement and new license for the Rock Creek/Cresta Project 1962 and the partial settlement agreement for Project 2105. Any alternatives analyzed in the EIR need to consider the relationship between the contemplated alternatives and the settlement agreements.

In support of the general observations and requests outlined above, Plumas County offers the following specific comments.

Elimination of Thermal Curtain Alternative

Plumas County opposes solutions to certain water temperature and fishery problems, such as the thermal curtain in Lake Almanor, that provide limited benefits in one area while potentially

harming our citizens' quality of life and negatively impacting our environment and recreation-based economy elsewhere.

Based on preliminary review of a number of proposals that attempt to reduce water temperatures in the North Fork, including the thermal curtain, it is evident that a great deal of money could be spent without producing significant benefits. Even under some of the most ambitious proposals, it appears there will be periods of time when it is impossible to meet 20°C temperature standards in the North Fork Feather River (NFFR) without significantly diminishing the cold water pool and degrading the cold water fisheries in Lake Almanor and Butt Valley Reservoir. There may even be periods of time when it is impossible to meet cold water temperatures in the NFFR without causing seasonal harm to the fishery in the Seneca reach.

Rather than devoting significant resources to even more examination of the thermal curtain schemes, the 2105 EIR analysis should focus on the mix of alternatives that provides the most environmental benefit in the NFFR with the least environmental impact to other water bodies.

With respect to those other alternatives mentioned in the Notice of Preparation, the proposal to construct mechanical water chillers at reach-specific locations is the only alternative besides the thermal curtain that would create significant new structures. Based on the preliminary information that has been advanced, it does not appear that chillers provide enough benefit to justify the cost of construction and operation, their negative environmental impacts, and the visual degradation to the North Fork Canyon. Perhaps chillers have a place in the Poe reach, but such a massive and unsightly installation would need to be designed and screened to fully mitigate visual impacts.

1962 and 2105 Settlement Agreements

Plumas County and its citizens have participated in good faith to arrive at the settlement agreements for Projects 1962 and 2105, and the commitments agreed to in those negotiations need to be honored to the greatest extent possible. The CEQA analysis should disclose how all alternatives under consideration will affect the existing 1962 and 2105 settlement agreements. Effects on the agreements should be a significant factor in determining "reasonable and feasible" temperature modification alternatives for the NFFR. Specifically, the CEQA analysis of alternatives should analyze and disclose:

- impacts to the summer water temperatures, summer lake levels, and cold water fishery of Lake Almanor and Butt Valley Reservoir
- how the temperature modification alternatives may affect the existing agreement for reservoir operations at Buck's Lake
- how temperature modification alternatives may affect the existing schedule of Western Canal water deliveries from Lake Almanor to Lake Oroville
- impacts to hydropower generation

The system-wide impacts of the chosen temperature modification alternatives should be displayed in a fashion that allows the public to visualize the impacts and tradeoffs between different river reaches and lakes – by each alternative and as clearly as possible. The impacts

and tradeoffs need to be displayed for the full range of conditions under consideration. At a minimum, this means

- showing water temperatures, air temperatures, flows in cfs, and residence times for water passage through different reaches of the NFFR system at different flows and temperatures during June, July, and August
- displaying water temperatures at both the top and bottom of each stream or lake reach where possible
- clearly labeling settlement agreement flows within the analysis
- clearly identifying all thresholds of significance

The blended climate/water temperature/discharge characterization of normal, cold-wet, hot-dry periods currently used by PG&E may be the best way to delineate and display a range of conditions for analysis. However, the CEQA analysis should independently evaluate and determine the most transparent method for characterizing and comparing temperature modification alternatives throughout the NFFR system.

The CEQA analysis should begin with daily mean water temperatures for normal years at a 50 percent to 90 percent exceedance in June, July, and August, and then, if needed, analyze dry and critically dry years at various exceedances. This analysis will help the public understand the effect of weather on controllable factors such as stream flow releases. The CEQA document should describe both pre-project and existing project conditions in terms of summer water temperatures and adult trout populations in the NFFR based on best available information. Any sources of information used in the CEQA analysis should be described as professional judgment, monitoring data, computer simulations, etc. with the range of accuracy or confidence clearly disclosed, by information source.

Shoreline Erosion

Shoreline erosion has and is continuing to have an adverse effect on environmental and social resources in the Lake Almanor environs. To mitigate for these effects, Plumas County requests that the SWRCB evaluate shoreline erosion in the EIR and impose conditions in the 401 Water Quality Certification that protect environmental and social resources around Lake Almanor. At a minimum, the SWRCB should require that PG&E update the shoreline erosion control plan in consultation with the SWRCB, resource agencies, and Plumas County. The County believes that PG&E's proposed erosion control plan included as part of the Shoreline Management Plan does not adequately address erosion sites that are adversely affecting resources, including Maidu cultural resources.

Plumas County recommends that the SWRCB include two conditions to protect Lake Almanor resources: a shoreline management plan and a shoreline erosion plan. FERC's recent issuance of a license for Portland General Electric's (PGE) Pelton Round Project provides a good example of the license/article 401 conditions recommended by the County. Both license conditions are included as Attachment 4 to these comments.

Article 428 of PGE's license requires a shoreline management plan. During the settlement negotiations, Plumas County and PG&E successfully negotiated a shoreline management plan

with which both could live. Plumas County asks that the SWRCB require PG&E to update the shoreline management plan to include a shoreline erosion plan acceptable to Plumas County and the SWRCB. Because the shoreline management plan did not receive sufficient public scrutiny, the County requests that PG&E present the plan to the public and solicit input on the plan.

Article 429 of PGE's license requires the licensees (the Warm Springs Indian Tribe is a co-licensee) to file a shoreline erosion plan within one year that 1) discusses the conditions and probable causes of shoreline erosion; 2) describes agreed upon actions, but not limited to what is already in the license article; and, 3) provides that all the actions conducted under the shoreline erosion plan be developed and implemented with a Shoreline Management Working Group. Within three years, the licensees are required to rehabilitate a number of erosion sites. The licensees are required to survey the shoreline area and prepare a baseline survey that maps resources that are affected by erosion (water quality, fish habitat, terrestrial habitat, or tribal reservation lands). Annual monitoring is required thereafter to monitor existing erosion and identify and map new erosion sites. At each erosion site the licensees are to establish a relocatable topographic survey transect. An annual report is to be produced that describes soil erosion control measures. In developing erosion control measures, the licensees are to give preference to soft erosion control techniques. The County recommends that an identical condition be included in the SWRCB's 401 Water Quality Certification.

As an additional shoreline erosion issue, during the settlement negotiations PG&E reiterated its right to erode areas that were conveyed to PG&E via the Red River and Clifford Deeds. However, the SWRCB is charged with protecting the environmental and social resources affected by the project, and in particular water quality and beneficial uses. A side agreement between PG&E and the previous owners of the Clifford and Red River deeds cannot preempt either FERC or the State Board's responsibility to protect environmental resources. As the licensee, it is PG&E's responsibility to remedy erosion problems that are damaging to environmental resources. Plumas County proposes to work with PG&E and the SWRCB to update PG&E's erosion plan to identify areas of eroding shoreline that are affecting terrestrial, water quality, fishery, cultural, recreational and socio-economic resources around Lake Almanor.

Supplemental Materials

The following items are presented as attachments to the comments of Plumas County:

Attachment 1 – Thermal Curtains and Watershed Restoration (CD)

(PowerPoint presentation with voiceover)

Attachment 2 - Watershed Restoration and Improvement Alternative

Appendix A – Description of Projects with Benefits and Costs

Appendix B – Watershed Data Archive

Appendix C - East Branch Water Quality and Fishery Monitoring Plan

Appendix D – Water Rights Notification Process

Appendix E – Last Chance Protocol and Lake Almanor Habitat Map (CD)

PowerPoint from Feather River Coordinated Resource Management Group (CD)

The Feather River CRM – 20 Years of Watershed Restoration (DVD)

Attachment 3 - Upper Feather River Integrated Regional Water Management Plan (CD)

Attachment 4 – Shoreline management and erosion provisions from Portland General Electric.



Attachment 2

Project 2105 EIR Scoping Comments **Watershed Restoration and Improvement Alternative**

Introduction

The County of Plumas requests that the State Board analyze the Watershed Restoration and Improvement Alternative (“Watershed Alternative”) presented below as part of the EIR for the water quality certification for FERC Project 2105. The Watershed Alternative provides for off-site mitigation in the East Branch of the North Fork Feather River, where mitigation benefits can be achieved in greater magnitude, at less cost, and without the redirected impacts of many of the mitigation alternatives being proposed within the Project 2105 boundary. Mitigation opportunities in the East Branch can produce water temperature and other water quality benefits in the North Fork and provide attendant habitat improvements – all in ways that are consistent with regional water management plans. The Watershed Alternative is offered as a stand-alone alternative or to be used in combination with other prudent alternatives.

Plumas County has a longstanding commitment to improving the economic and environmental health of the Upper Feather River watershed – more than seventy percent of which lies within the County’s jurisdiction – for the benefit of County residents and visitors and for more distant beneficiaries. Plumas County has consistently advocated a collaborative and watershed-based approach for balancing beneficial uses in the North Fork Feather River. As stated in the Integrated Regional Water Management Plan for the Upper Feather River:

It is apparent to most decision-makers in the watershed that piecemeal planning constrains the range of potential solutions to the region’s most pressing conflicts. By building on the wealth of hands-on watershed restoration experience, project-scale monitoring, and institutional capacity it will become possible to expand water management and planning to larger scales when water management conflicts require larger scale solutions.

In the context of the relicensing of FERC Project 2105 and the management of the North Fork, Plumas County opposes solutions to certain water temperature and fishery problems, such as the thermal curtain in Lake Almanor, that provide limited benefits in one area while potentially harming our citizens’ quality of life and negatively impacting our environment and recreation-based economy elsewhere.

Based on preliminary review of a number of proposals that attempt to reduce water temperatures in the North Fork, it is evident that a great deal of money could be spent without producing significant benefits. Even under some of the most ambitious proposals, it appears there will be periods of time when it is impossible to meet 20°C temperature standards in the North Fork Feather River (NFFR) without significantly diminishing the cold water pool and degrading the cold water fisheries in Lake Almanor and Butt Valley Reservoir. There may even be periods of time when it is impossible to meet cold water temperatures in the NFFR without causing seasonal harm to the fishery in the Seneca reach.

Instead, other alternatives may provide comparable downstream benefits with more adaptive management flexibility and fewer redirected impacts. From a review of currently available data, three degrees of coldwater improvements in the Rock Creek/Cresta Reach of the NFFR in normal water years may be achieved in a number of ways. In particular, the East Branch of the North Fork is a significant source of hot water for the river and presents a mitigation opportunity for the North Fork system that is begging to be seized. For that reason, Plumas County is proposing the Watershed Alternative for off-site, compensatory mitigation in the East Branch, as detailed in the following pages.

Watershed Alternative

After extensive review and years of participation in the collaborative licensing processes, Plumas County has concluded that off-site mitigation is the most feasible and effective way to address the irreversible and continuing loss of coldwater habitat for trout resulting from hydro-modification of the NFFR system. Trout have lost access to historic coldwater refugia and spawning habitat in the main channel and the tributary streams of the NFFR. These impacts are permanent and cannot be adequately mitigated by any practical means. PG&E's hydroelectric dams block trout from migrating up and down the NFFR to seek suitable coldwater habitat. Without fish ladders, the continuing blockage of fish passage cannot be mitigated on-site, in the NFFR. Creating further detriment, the Rock Creek, Cresta and Poe reservoirs warm NFFR water beyond temperatures that would have occurred under free flowing river conditions.

Plumas County supports efforts by the Department of Fish and Game, the Plumas National Forest, the 1962 ERC, and others who are working to improve fish spawning habitat and coldwater conditions and other protections (such as increased warden presence) for the improvement of the coldwater fishery in the NFFR Canyon. To complement those efforts, Plumas County proposes the Watershed Alternative - offsite compensatory mitigation for 2105 and the cumulative impacts of the other PG&E projects on the North Fork. The Watershed Alternative is offered as a stand-alone alternative or to be used in combination with other alternatives.

The Watershed Alternative confronts the dilemma of incremental improvements in water quality and the coldwater fishery in the NFFR being achievable only by degrading the coldwater fishery and summer water quality in Lake Almanor. The Basin Plan's designated beneficial uses for Lake Almanor should not be impaired by efforts to improve preexisting conditions in the NFFR – conditions that have existed for nearly a century and that pre-date State Board Resolution 68-16 and the federal Clean Water Act by more than 50 years.

Instead, the Watershed Alternative should be used to improve stream reaches elsewhere in the North Fork watershed as off-site, compensatory mitigation for not achieving the last marginal and costly increments of coldwater fishery and temperature improvements in the NFFR. Plumas County supports improving coldwater fisheries and summer water quality throughout the North Fork system, including Lake Almanor and Butt Valley Reservoir. However, degrading Lake Almanor for a final increment of benefit in the NFFR is not “worth it” at any price, even if such a trade-off is technically feasible.

The Watershed Alternative was initially set forth in an August 1, 2005, document prepared for the 2105 Licensing Group collaborative. The latest version of the document is attached as Appendix A and includes a detailed description of Plumas County's proposed projects and their estimated costs and benefits. The following sections of this document further describe aspects of the 17 proposed restoration projects in four subwatersheds of the East Branch of the North Fork, including their environmental benefits and the linkages to Project 2105.

Watershed Alternative and NOP Feasibility Criteria

The State Board's Notice of Preparation (NOP) for the EIR sets forth criteria for evaluating the feasibility of alternatives, and that evaluation will inform the decision on which alternatives to include and analyze in the EIR. The sections below address aspects of the Watershed Alternative in the context of the evaluation criteria stated in the NOP.

Temperature Moderating Benefits to the Affected NFFR Reaches

The entire Watershed Alternative is based upon the premise that for any given level of effort and expenditure, temperature benefits and corresponding habitat improvements can be achieved in a much greater magnitude in the vast, free-flowing expanses of the East Branch of the North Fork than in the highly modified and flow-controlled reaches of the river system from Canyon Dam to Bid Bend. Therefore, the Watershed Alternative does not directly affect temperature in the reaches from Canyon Dam to the confluence with the East Branch, but it does provide significant compensatory benefits in the East Branch as well as some benefit in the North Fork below the confluence.

The North Fork canyon within the 2105 project boundary is unique, and there are no comparable mitigation opportunities in the region. However, within the larger North Fork system, there are canyon stream reaches in the East Branch that are comparable to the river sections within the 2105 boundary, although they are smaller and interspersed with alluvial valleys. Degraded conditions in those valleys provide mitigation opportunities that will improve water quality and biological connectivity in the canyon reaches. Given the biological and hydrological connection between the North Fork and its East Branch, the EIR analysis should include the potential for mitigation of cumulative effects in the watershed through off-site mitigation.

Jim Wilcox is the Program Manager for the Feather River Coordinated Resource Management Group. In his professional judgment, which is based on 20 years of watershed restoration experience in the Upper Feather River Basin, full implementation of the Watershed Alternative would delay the onset of temperature exceedances in the NFFR by two weeks in a normal year and provide water temperature improvement throughout the summer. Although the East Branch contributes a relatively small portion of the total North Fork summer flow, it is a significant source of hot water. Unlike the river reaches from Canyon Dam to Big Bend, there are numerous opportunities in the East Branch system for the restoration of natural conditions and processes that will in turn reduce hot water. If Project 2105 is operated at historic capacity from mid-July through August, the temperature influence of the East Branch is minimal, but that influence increases commensurately with any reductions in power production.

Cost of Implementation Versus Predicted Benefits

Based on PG&E's 4-D report, a two-week delay in the need to reoperate the 2105 hydro-electric system at Lake Almanor, Butt Valley Reservoir, and Belden equates to an avoided cost of about \$1 million per year that would otherwise be lost in power generation in the month of July. Depending on the term of the new license, savings would be on the order of \$30 to \$50 million in today's dollars. The Watershed Alternative is estimated to cost \$30 million over the same period, and Plumas County proposes to augment PG&E's contributions with funds from other sources. Therefore, the Watershed Alternative warrants analysis for cost reasons alone.

In contrast to the other temperature modification alternatives under consideration, the benefits of the Watershed Alternative are realized year-round and provide much broader environmental enhancements. The Watershed Alternative improves habitat for riparian, wetland, and aquatic species on 80 stream miles of the East Branch and provides meadow floodplain restoration to 6,000 acres. In comparison, there are less than 40 stream miles in the main stem of the North Fork.

Implementing the Watershed Alternative in combination with reasonable and feasible temperature modification measures in the NFFR Canyon addresses up to three times more riverine and coldwater fish habitat than a "no project" alternative. Improving up to 120 miles of river in the main stem and the East Branch can enhance biological connectivity in the whole North Fork system – which is one of the goals of the Integrated Regional Water Management Plan for the Upper Feather River.

Incidental Environmental Effects

The local Feather River Coordinated Resource Management Group (Feather River CRM) has implemented over 40 stream bank erosion control and meadow re-watering projects since 1985 on public and private lands in the Upper Feather River Basin. Project monitoring combined with modeling-based predictions (Linda Bond, 1997; Rick Kattlemen, 1987) suggest that meadow and stream restoration in combination with upland vegetation management could reduce downstream flood peaks by five percent for the first 24 to 36 hours of a severe winter storm, while enhancing summer base flows by seven percent. Measurements of flood events (when possible) have shown that 50 cfs discharges in channels are associated with 5cfs flows on adjoining floodplains during the same flood period (Kossow-Cawley, 1987). Dr. Bond estimates that restoring groundwater storage in the 200,000 acres of degraded meadows in the Upper Feather River Basin would increase late season surface water yields by 100,000 or more acre feet in normal and wet years. In 1999, Dr. Jeff Romm, an economist at UC Berkley, conducted a cursory survey of the value of restoring natural watershed processes in the Feather River watershed and concluded that "in certain conditions, riparian and meadow restoration can actually enhance water storage more efficiently than dam augmentation."

Based on professional judgment by the FR-CRM staff and based on data that has been collected by the FR-CRM (see Appendix A), the Watershed Alternative could mitigate water temperatures by 3°C to 9°C or more in June, July, and August in specific stream reaches of the East Branch.

When compared to other temperature modification alternatives under consideration by the State Board, the Watershed Alternative could provide as much as three times the peak stream temperature mitigation, depending on the characteristics of particular stream reaches in the East Branch. In most cases, water temperatures of 20°C could be achieved in June, July, and August of normal years within 10 years of initiating restoration treatments. PG&E's July, 2005, 4-D report states that trout useable wetted habitat would increase by an average of about 5 percent and a maximum of about 15 percent in the NFFR as a result of a variety of temperature modification alternative measures. We recognize that these estimates are preliminary and may be revised upward. We predict that the Watershed Alternative will increase trout habitat by 10 percent to 30 percent or more, as measured by the National Forest Stream Condition Inventory (SCI) protocol. (See Appendix C for more information on the SCI protocol).

Scientific Basis for Watershed Improvement Alternative

Watershed-wide erosion identified in a 1989 study conducted by the Soil Conservation Service (now called the Natural Resources Conservation Service) is one symptom of an overall loss of watershed function. Other symptoms include increased flood peaks and flood damage frequency, water quality impairments (nutrients and temperature, as well as sediment), and the ongoing loss of aquatic and terrestrial habitats. The primary physical process resulting in these symptoms is channel incision in the meadows and valleys of the upper two-thirds of the watershed (Clifton, 1994). Once initiated, incision/stream bank erosion continues until a new channel base level is reached. On many of the larger channel systems this erosion and channel widening and deepening process has reached depths of 14 to 16 feet and widths of 300 feet or more, far beyond the range of natural width/depth ratios in healthy streams. The incised channel continues widening by eroding the stream banks below the protective rooting depth of the native meadow sod. As the incising channel capacity increases more stream flow is captured, further severing the stream from the naturally evolved flood plain. In many areas of the watershed virtually no flood flows now access the historic flood plains. The concentration of stream flows and the desertification of the original riparian vegetation community further weakens stream banks, creating ongoing cycles of erosion, dewatered meadow aquifers, peak summer heating temperatures, and the continued loss of coldwater fish habitat.

After the winter precipitation and runoff season ends, surface water flow derives almost entirely (80% or more) from groundwater and tributary flows (Benoit). In healthy systems, fully recharged groundwater aquifers feed surface flows throughout the summer. Some models estimate that shallow meadows completely drain groundwater into streams in one to three year's time, depending on each previous year's precipitation (Loheide). Mature riparian and aquatic vegetation, and defined and self-maintaining pools and riffles (ideally at a 1:1 ratio), maintain cooler stream temperatures and provide cold water refugia for fish, even during prolonged peak heating spells during the four to five month summer droughts that are common to this watershed.

Project-Level Impacts of Restoring Watershed Function to East Branch Streams

The Indian Creek Watershed Study (Soil Conservation Service, 1993, pp. 37-38) predicts a 2.3°F reduction in summer stream temperatures from a 25 percent increase in riparian shading and a 3.9°F decrease in summer stream temperatures from a combination of 25 percent increase in

riparian cover and a 50 percent decrease in stream width in Indian and Genesee Valleys. Genesee and Indian Valleys are the largest and lowest elevation valleys in the East Branch. Other experts have documented 2 to 4 or more degrees F cooler water in stream pool bottoms (Flint, Theiss, Kavvas: personal communications). A possible outcome from successful stream rehabilitation could be as much as 8-15° F cooling of stream waters at the bottoms of pools three feet and deeper that are overhung by at least 25 percent riparian vegetation. This outcome would be achievable within 10 years, depending on vegetation recovery and post-project vegetative management. As an example, monitoring of the recently completed Last Chance Creek meadow rewatering and stream rehabilitation project has documented a 10°F reduction in stream temperatures from the top of the project area to the downstream end of the project (4 miles) in June 2004, the first year after reconstruction (Wilcox).

Reconnecting restored stream channels to re-watered floodplains would add longer influxes of 50° to 58°F groundwater to summer baseflows, with an unknown but potentially significant additional cooling downstream. The 1994 project at Big Flat demonstrated a 30-day extension of perennial flow in ephemeral Cottonwood Creek from groundwater accretion after completion of the project. Groundwater temperatures in the gravels in the rewatered reach were 50° to 58° F (Wilcox, Seagraves). The Big Flat project on one mile of Cottonwood Creek produced a trout increase of 1,000 rainbow trout per mile, post-project, compared to zero trout per mile in the pre-project condition (Mink). This project achieved such dramatic gains in coldwater fishery populations through a combination of habitat and water quality improvements. A low width (2-4')-depth (4'-6') sinuous channel with undercut banks was constructed and the 47-acre adjoining floodplain was re-watered. Groundwater inflow from uplands and the adjoining meadow was reconnected to the stream channel so that groundwater accretion to the channel was prolonged. Stream temperatures were maintained by the low width-depth ratio. Wetland vegetation development in combination with grazing management has improved coldwater trout habitat during a longer period of the summer (Mink).

In the "Red Clover Demonstration Project Research Summary Report (1985-1995)", the following information is presented. "These results show that substantial heating of the stream occurs upstream of the demonstration area. They also show that the ponds were deep enough to provide pockets of water that were considerably cooler 20°C was exceeded 71-98% of the days near the surface of the pond (3 foot depth) compared to 0-55% of the days at the bottom (8 foot depth). Exceedance of 22°C near the surface occurred on 31-74% of the days compared to 0-16% at the bottom of the pond." Surface stream temperatures upstream of the project reached 27.5°C and 29.7°C during the same July-August, 1989-1993 period. And it is important to note that the ponds were completely unshaded. The authors conclude that "Lowering water temperatures throughout Red Clover Creek would require substantial channel narrowing and development of riparian cover, possibly in combination with increased base flows from groundwater" (Seagraves, 1995, pp. 8-10).

In the Red Clover Demonstration Project, as in the NFFR, lack of spawning habitat, intense competition for coldwater refugia (with non-game fish species), and selective predation (including poaching) are important causes of decreased rainbow trout abundance and reproductive success, along with water temperatures. Lack of spawning habitat in the Red Clover Project led directly to the innovative "pond and plug" meadow rewatering design as an

alternative to traditional instream check dam installations. As the now-preferred way to rewater meadows and to reconnect streams and floodplains, “pond and plug” restoration treatments plug the eroding gully with fill collected from off-stream pond development. A small narrow sinuous stream channel is allowed to develop, or is reconstructed, on top of the re-watered and pond filled floodplain. In this way, pool-riffle stream features are reestablished and spawning habitat is enhanced because ponds do not replace free flowing streams, as they do in instream check dam designs. Instead, off-stream ponds replace the old gullies, and a free-flowing stream redevelops down the low point of the meadow.

Project Prioritization in the Watershed Alternative

According to a recent report from the State Board:

Much of the upper Feather River watershed has been affected by 140 years of intensive human use. Mining, grazing, timber harvesting, wildfire, and railroad and road construction have all contributed to watershed degradation, which is down cutting and widening of tributary streams, causing erosion/sedimentation, increased water temperature, and other adverse impacts on water quality, fisheries, and aquatic habitat.

Watershed Management Initiative, State of the Watersheds Report, Feather River Subwatershed, 2002, pp. 10-14.

All of the proposed project areas in the Watershed Alternative exhibit the legacy watershed degradation attributes described by the State Board. The following conceptual framework is the scientific basis for the project prioritization that is presented in the tables in Appendix A:

- Inadequate cold water in lakes and streams limits water quality in the summer and fall.
- Excessive stream bank and road-related erosion from flood flows limits water quality during the winter and spring.
- Restoring groundwater recharge through enhancing floodplain and flood-way processes lessens erosive flood forces in stream channels.
- Restoring groundwater recharge in meadows and forested uplands prolongs base flows in streams through enhanced groundwater influxes to streams during the summer-fall drought.
- Integrating surface water and groundwater management for better drought and flood management provides an opportunity to increase cold water in lakes and streams during the summer-fall drought period.

Priority 1 projects are mostly “meadow re-watering projects” which means that the project includes reconnecting the stream to its natural meadow floodplain and to the groundwater aquifer that is associated with the historic meadow-floodplain. Priority 1 meadow re-watering projects create significant seasonal and permanent wetland habitat and recreate summer-long groundwater influxes to streams as rewatered aquifers naturally drain downslope and downstream during the summer-long drought. Because groundwater temperatures range from 50° to 58° F, floodplain aquifers provide a significant source of cooler summer water to streams both within and downstream of a restored stream reach.

Priority 2 projects are mostly “geomorphic reconstruction projects” that are installed in confined, eroding stream channels with narrow floodplains that have formed within eroding gullies in meadows. For a variety of reasons, it is no longer feasible to reconnect the stream to its historic floodplain meadow. Rehabilitation of the stream and riparian system must be confined within the eroding gully. Rehabilitation work in stream systems that are unconnected to their historic meadows and floodplains is inherently more risky than work in natural stream and floodplain-meadow systems. Entrenched or incised streams, as they are called, carry larger volumes of floodwaters within their stream channels rather than spreading higher flood flows across wide floodplain meadows. Concentrating flood flows within a narrower cross-sectional area of the erosion-caused gully exponentially increases the erosive force of flood waters. In addition, streambank vegetation in entrenched or incised channels tends to be less vigorous, because incised channels are more isolated from groundwater inflows during the summer growing season. More stream power combined with weaker vegetative protection creates the potential for higher failure risks and longer recovery times for incised streams.

Restoration projects have generally been implemented in a downstream direction from the headwaters, so that the benefits from upstream projects accrue to future projects downstream. Downstream, the stream systems and alluvial valleys become larger, and current watershed stresses such as urbanization, water diversions, stream channelization, and flood control become larger factors in restoration designs. The rehabilitation of the upstream watershed has the potential to help seed lower river reaches with excess productivity from increased populations of the macroinvertebrate, fishery and riparian communities. During the months of primary water temperature concern (July and August), the restored reaches upstream could act as areas of refuge along with the cooler tributary streams.

The tables in Attachment 3 summarize the Watershed Alternative in as much detail as is available at this time. The Priority 1 reaches identified are located in three subwatersheds: Last Chance, Red Clover, and Indian Creeks. Last Chance and Red Clover are at the upper end of the East Branch watershed. Lower Indian Creek is the next subwatershed downstream. The Priority 1 reaches vary from one to ten stream miles in length, and include 70 to 1,000 acres of adjoining meadow-floodplain. The Priority 2 reaches are located in the Spanish Creek and upper Indian Creek subwatersheds. These reaches vary from three to seven miles in length and affect 90 to 1,000 acres of floodplain and meadow. Water from each of these reaches eventually flows into the East Branch and North Fork Feather River.

Project Risks and Benefits

In the best of circumstances, benefits can be fully realized in three to five years in meadow re-watering projects of unconfined systems (Priority 1) and in eight to ten years in confined stream reaches (Priority 2). The duration of benefits is probably up to a 45-year magnitude flood event for mature Priority 2 projects in confined systems, and may be up to a 75-year or greater magnitude flood event for mature Priority 1 projects in unconfined stream systems.

The timing of benefits and costs is most dependent on the time interval between project implementation and the next peak flood event and whether the treated stream is entrenched or

unconfined and grazed or ungrazed. A 100-year flood occurring in the first runoff season after the installation of a Priority 2 project in a confined system creates a risk of significant damage because vegetation has not had enough time to become established. Priority 1 unconfined systems, protected by the energy dispersal of the floodplain, have a much lower (10%-20%) risk of substantial damage from a 100-year flood in the first year after construction and revegetation.

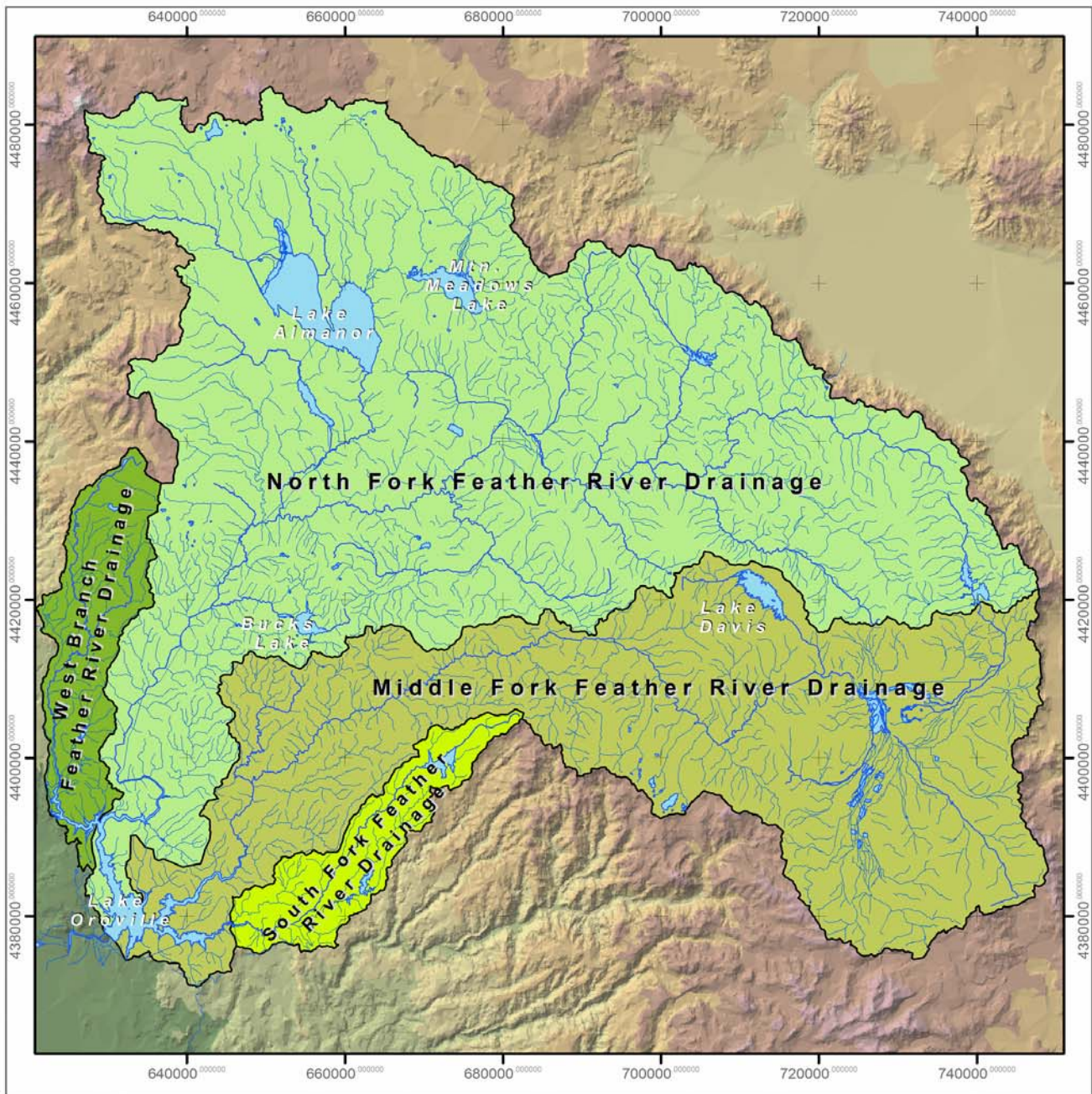
Whether a peak flood event is the last high flow event of a runoff season or the first event in a series of high water events in a season also affects the risks for damages in any given year. If a project has the next summer growing season to recover from the damage of the last winter flood event, there will be less risk of damage from future flood events. For example, the Wolf Creek geomorphic reconstruction project in Greenville, which was constructed in 1989, has demonstrated that vanes are a streambank treatment in confined systems that were capable of withstanding the 1997 flood velocities eight years after construction and revegetation. Pre and post-project photos are presented below.

Wolf Creek Vane Project



As a final note, the predicted benefits presented in Appendix A are based on the professional judgment of the FR-CRM staff. The FR-CRM and its subcontractors include professional hydrologists, fishery and wildlife biologists, botanists, and soil scientists with decades of professional experience in the upper Feather River Basin. Monitoring data reflects the project priorities and performance criteria for individual projects. Early FR-CRM projects focused on erosion control, often in seasonal, second and third order streams. Ephemeral streams were discharging disproportionate sediment loads into downstream perennial stream reaches.

It is important to note that all projects are voluntary, with full landowner cooperation, and designed to achieve maximum onsite and downstream benefits. Appendix D describes downstream effects for other water rights holders resulting from the projects, and also provides an example of the FR-CRM's experience in coordinating these types of projects with other affected parties.



Legend


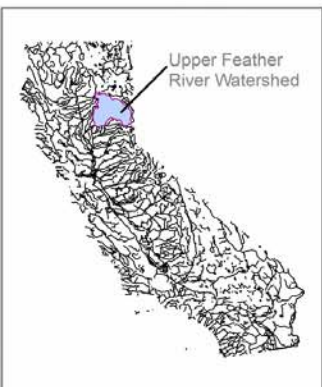
- Streams
- Lakes and reservoirs
- Rivers

Major River Drainages

- Middle Fork Feather River
- North Fork Feather River
- South Fork Feather River
- West Branch Feather River

FIGURE 4.9
UPPER FEATHER RIVER
MAJOR RIVER DRAINAGES

Watershed base map depicting the major river drainages of the North, Middle, South, and West Branch Feather River. The water from each major river drainage flows into Lake Oroville.

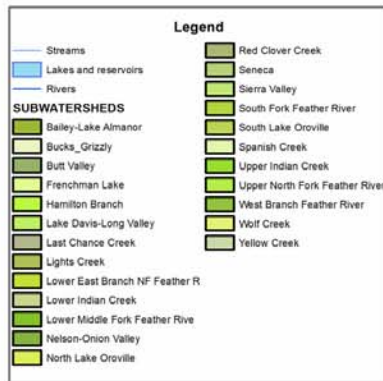
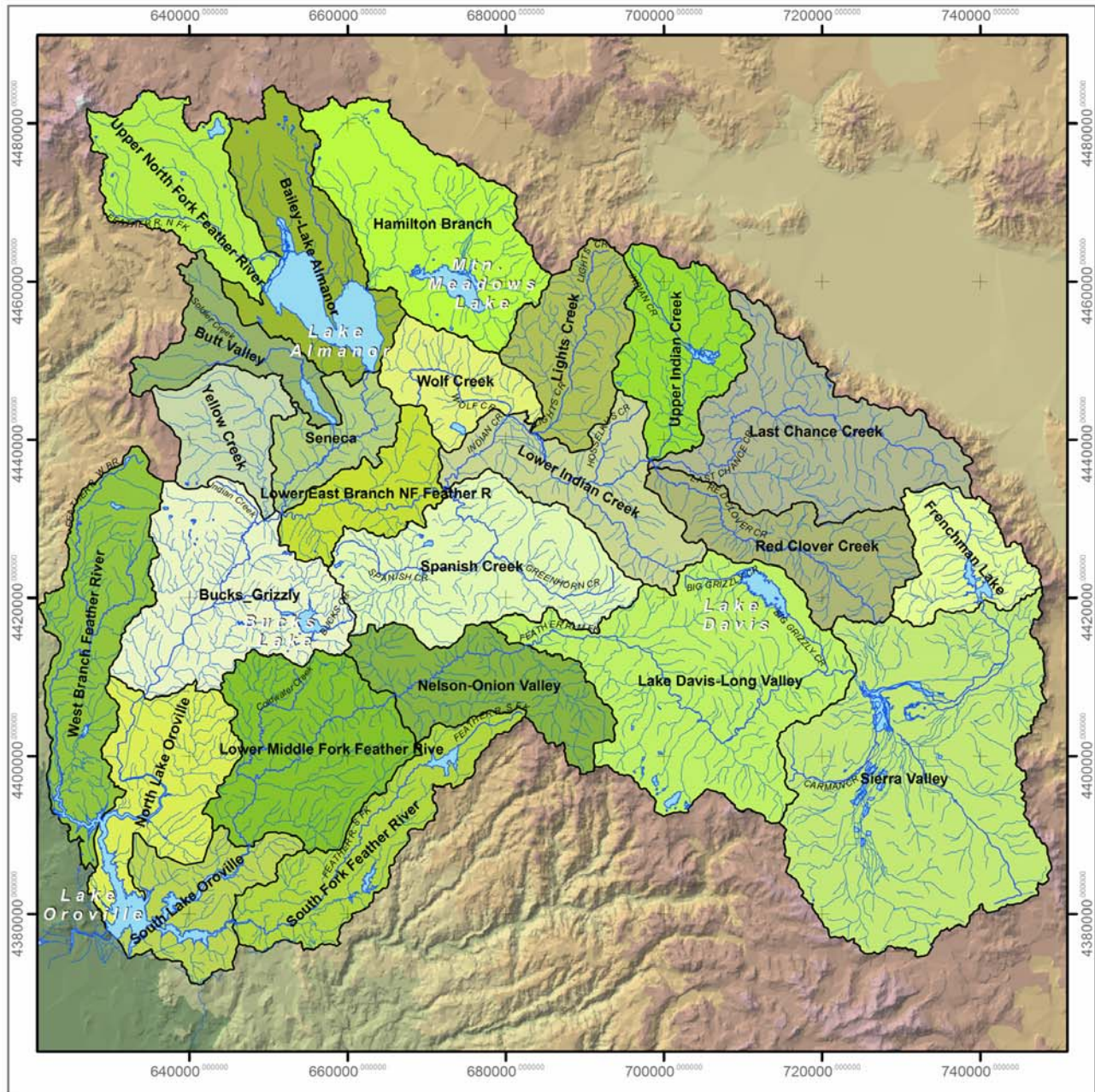


FIGURE 4.8
UPPER FEATHER RIVER
SUBWATERSHEDS

Subwatershed base map depicting smaller hydrologic catchments within the greater watershed.

GIS Metadata Information
 Subwatershed delineation shapefile:
 California Spatial Information Library CASIL



STAFF CONTACT INFORMATION:

Terry Benoit, Project Manager
Feather River Coordinated Resource Management Group
530-283-3739
terry@plumascounty.org

Tom Hunter, Director of Public Works
Plumas County
530-283-6268
pcpw@psln.com

Levent Kavvas
California Hydrologic Research Lab
M.L.Kavvas@sbcglobal.net

Leslie Mink, Monitoring Coordinator
Feather River Coordinated Resource Management Group
530-283-3739
leslie@plumascounty.org

Jim Wilcox, Program Manager
Feather River Coordinated Resource Management Group
530-283-3739
jim@plumascounty.org

Leah Wills
Plumas County
530-284-7294
leah2u@frontiernet.net

All studies referenced and quoted in this report are available on the FR CRM website at www.Feather-River-CRM.org under “Publications.”



Appendix A

Watershed Restoration and Improvement Alternative

Description of Projects with Benefits and Costs

The Watershed Alternative is a proposal to fund the implementation of coldwater watershed improvement via projects as well as appropriate aquatic resources and water quality studies throughout the upper North Fork Feather River (NFFR) watershed, including the East Branch (EB) and other tributaries. The Plumas County Flood Control and Water Conservation District (PCFC&WCD) will implement projects in cooperation with Feather River Coordinated Resource Management (FR-CRM) and other groups (e.g. Plumas Water Forum, Resource Conservation Districts). The projects will be designed to address stream temperature improvement and additional beneficial uses as described in the Central Valley Regional Water Quality Control Board Basin Plan including cold freshwater habitat, domestic and agricultural water supply, recreation, and hydropower generation. The activities initiated under this alternative will include ongoing prioritization for both public (including NFS lands) and private lands and may include those identified as priority projects to address on-going temperature and sediment issues in the North Fork Feather River in existing studies and planning documents such as FR-CRM MOU (1985) and Feather River Watershed Management Strategy (2004). The activities will be consistent with guidance included within the Integrated Regional Water Management Plan (Plumas County, July 2005).

Potential projects identified at this time for implementation in the first fifteen years of the license are included on the list below, and include effectiveness monitoring throughout the term of the license. During the implementation phase, monitoring of existing and constructed projects will provide a feedback loop to maximize the effectiveness of projects as they are implemented. This alternative will include the following actions:

- Implement priority restoration projects as identified in existing plans for the watershed or identified in the future by the implementing authority. Foster and support innovative restoration projects.
- Develop a monitoring plan that addresses project effectiveness and contributes to increased understanding of stream temperature dynamics and coldwater sources during late summer months. The monitoring plan will also track the sustainability of implemented projects and identify any maintenance needs. Consider utilizing thermal imaging technology (helicopter flights currently used) to establish baseline stream temperatures, identify cold and warm water sources and provide periodic review of benefits derived. Continuous recording thermographs will be installed at key areas throughout the watershed to build on the existing FR-CRM network. The monitoring plan will include an aquatic resources and habitat monitoring component on a sub-watershed scale to complement other monitoring efforts in the watershed.
- Maintain or modify implemented projects if necessary to establish self-sustainability.
- Develop a central data archive as a repository to collect information that is currently maintained by various entities and to utilize information more efficiently, track activities, and monitor results (see Appendix C). This information will assist in determining real

and potential effects in the EB and the NFFR, and the downstream effects of restoration projects on water temperature and aquatic productivity in the watershed.

- Utilize information from selected stream restoration projects to aid in future project design considerations.
- Identify and implement as appropriate on-site and off-site projects that reduce temperature, reduce sedimentation, and improve aquatic habitat. This may include culvert modification, fish ladder installation, and other measures to improve access to cold-water refugia.

Assumptions:

- This alternative assumes that all reasonable on-site alternatives to reduce daily mean water temperatures to 20 degrees C in the NFFR within the FERC 2105, 1962, and 2107 project boundaries have been identified. Actions (except for construction of the Prattville Curtain) included in the FERC 1962 license to address temperature will be implemented.
- Modeled and measured daily mean water temperature will exceed the 20 degrees C goal in the NFFR within the project boundaries at certain times even with implementation of any of the previously evaluated 24 water temperature reduction alternatives either singularly or in combination.
- Portions of the NFFR and EB watersheds can be restored to improve cold-water habitat.
- It is possible to bring alluvial valley and canyon streams in Plumas County much closer to their natural function to provide cold-water habitat and cold-water supply.
- The Union Pacific Railroad, CalTrans, and other landowners will be invited to become active participants in the watershed restoration activities, especially regarding fish passage into coldwater tributary channels in the NFFR Canyon.
- It is unknown what synergistic effect upper watershed restoration activities would have on temperatures within the lower Belden, Rock Creek-Cresta and Poe reaches. Long-term monitoring of these actions may show a reduction of EB thermal input to the NFFR system. On-going project monitoring in the watershed has shown local water temperature improvements resulting from restoration (see table below showing monitoring results from 1985-2005)
- Funding will be escalated for inflation through the term of the license.

Rationale:

- Water-temperature modeling efforts have shown the EB to be a primary source of warmer water into North Fork project waters between the confluence with the NFFR and Belden Powerhouse.

- Available information (Integrated Regional Water Management Plan, July 2005) prioritizes the following specific sub-watersheds within the NFFR watershed as suitable and cost-effective for restoration: Last Chance; Red Clover; Spanish Creek; Lower Indian; Upper Indian; Lake Davis-Long Valley; and Sierra Valley. (See table below for proposed projects and estimated costs and benefits).
- Potential for leveraging other funding sources (see table below of Historic Funding Sources).
- Headwater areas can more readily be fully restored to proper fluvial and floodplain function (less land use restrictions). Restoration can result in reduced peak run-off and extend the natural hydrograph to help reduce downstream water temperature in the East Branch and increase natural base flows.
- Opportunities to work in mid-watershed valleys to maintain headwater temperature and other beneficial uses (e.g. Indian, American, Genesee valleys) will require the interest of willing landowners. While landowner interest has been slowly but steadily evolving, the pace is expected to increase markedly above existing levels due to new (2004) Clean Water Act Agricultural Waiver compliance regulations.
- The EB includes priority sub-watersheds associated with large floodplains and valleys as identified in the Feather River Watershed Management Strategy (Monterey Agreement, 1994).
- Biological connectivity – Rehabilitation of the upstream watershed has the potential to help seed lower river reaches with excess productivity from increased macroinvertebrate, fishery, and riparian communities.
- Other water quality improvement benefits include reduced sedimentation and turbidity.

Other Considerations:

- Potential for salmonid fish passage actions that might necessitate additional enforcement personnel to address poaching (relates to measurement criteria to be used to evaluate effectiveness of upstream restoration activities)
- Supports implementation of Central Valley RWQCB Agricultural Waiver Compliance Program

Implementation Strategy:

The alternative would have a ‘front-loaded’ schedule to initiate restoration activities during the first 15 years after issuance of a new project license (FERC No. 2105) and allow adequate time to monitor long-term synergistic responses within the NFFR watershed and provide valuable information for use during future NFFR relicensings.

Conclusions:

The potential benefits of the NFFR Watershed Restoration Alternative are significant and include but are not limited to improving stream health, water quality and other beneficial uses in both upper watershed and lower project waters. The NFFR Watershed Restoration Alternative also includes compiling information from multiple agencies' stream restoration projects and the potential to leverage outside funding for expanded project implementation and management. To be fully successful, this alternative requires a long-term commitment of resources, which will be guaranteed through FERC enforcement of license articles. The Proposed alternative warrants additional analysis and consideration.

Projects Completed and Benefits Monitored 1985-2005*

<u>Stream Name/Phase Project Type</u>	<u>Total Treated Miles/Acres</u>	<u>Total Cost/ Completion Date</u>	<u>Fishery Benefits¹</u>	<u>Temperature Benefits²</u>	<u>Other Benefits Observed</u>	<u>Comments</u>
Last Chance Valley Cottonwood/Big Flat Meadow re-watering	1.0/47	\$100,000 1995	Pre-restoration: no trout observed Post-restoration: 1,280 trout per mile	Estimated 2°C water temp decrease in treated area in 1998	Downstream spring flow duration extended. Terrestrial and riparian vegetation and wildlife habitat improved; increased riparian and meadow productivity; decreased erosion	
Last Chance Valley- Clarks Creek Phase I Meadow Re-watering	1.0/56	\$75,000 2001	No data available	No data available	Terrestrial and riparian vegetation and wildlife habitat improved; increased riparian and meadow productivity; decreased erosion	Project implemented during drought
Last Chance Creek- Stone Dairy Meadow re-watering	0.6/22	\$56,000 2001	No defined channel for fish habitat	No data available	Decreased erosion; increased water storage. Terrestrial and riparian vegetation and wildlife habitat improved; increased riparian and meadow productivity.	Intermittent drainage
Last Chance Creek Mainstem Phase I (CalFed) Meadow re-watering	7.0/800	\$980,000 2004	Fish population in Last Chance Creek watershed steady decline in three sampling efforts between 1997-2005; unknown causal factors. No post-restoration data available	Measured 10.7°F water temp decrease for 4.8 miles in June 2004; 1.7°F water temp decrease in daily maximum at Jordan Flat June- July 2005; 4.5°C water temp	Decreased erosion; increased water storage. Terrestrial and riparian vegetation and wildlife habitat improved; increased riparian and meadow productivity.	Water temperature monitoring difficult due to ephemeral channels. Last Chance Ck. is still recovering from project construction completed in 2004. Additional restoration to continue in 2005.

<u>Stream Name/Phase Project Type</u>	<u>Total Treated Miles/Acres</u>	<u>Total Cost/ Completion Date</u>	<u>Fishery Benefits¹</u>	<u>Temperature Benefits²</u>	<u>Other Benefits Observed</u>	<u>Comments</u>
				decrease at Alkali Flat.		
Red Clover Creek Demonstration Project Check dams	1.0/70	\$172,000 1985	Pre-restoration: no trout observed Post-restoration: 4-32 trout observed in pools behind check dams	No data available	Waterfowl habitat improved; 588 waterfowl in project acre; 23 waterfowl in control area	Lack of spawning habitat is a limiting factor. Accurate sampling in ponds problematic. Coldwater refugia created by deep ponds behind check dams and immediately downstream
Red Clover Creek- Bagley Creek Meadow re-watering	0.3/15	\$9,000 1997	No data available	No data available	Decreased erosion; increased water storage. Terrestrial and riparian vegetation and wildlife habitat improved; increased riparian and meadow productivity.	
Indian Creek- Boulder Creek Meadow re-watering	0.6/30	\$22,000 1997	No data available	No data available	Decreased erosion; increased water storage. Terrestrial and riparian vegetation and wildlife habitat improved; increased riparian and meadow productivity.	
Indian Creek -Ward Creek Meadow re-watering	1.0/165	\$220,000 1999	No data available	No data available	Decreased erosion; increased water storage. Terrestrial and riparian vegetation and wildlife habitat improved; increased riparian and meadow productivity. Increased waterfowl and deer populations.	
Indian Creek- Hosselkus Creek, Phase I /II	0.75/65	\$156,000	Not applicable	Measured 4.5°C water	Increased water storage; Terrestrial and riparian	Ephemeral stream channel – no fish habitat

<u>Stream Name/Phase Project Type</u>	<u>Total Treated Miles/Acres</u>	<u>Total Cost/ Completion Date</u>	<u>Fishery Benefits¹</u>	<u>Temperature Benefits²</u>	<u>Other Benefits Observed</u>	<u>Comments</u>
Meadow re-watering		2001/2006		temperature decrease thru 1400' of treated area on June 27, 2005	vegetation and wildlife habitat improved; increased riparian and meadow productivity.	
Indian Creek - Wolf Creek Phases I-III (through the town of Greenville) Geomorphic channel reconstruction and re-vegetation	2.5/70	\$600,000 1990-1999	Pre-restoration: no trout captured Post-restoration: no trout captured in 2001 or 2003	Pre-restoration: No data available Post-restoration: daily water temp increase <1°F in one mile of treated area through Greenville	Terrestrial and riparian vegetation and wildlife habitat improved; increased riparian and meadow productivity.	Lack of trout capture may be result of urban setting. A temperature increase of less than 1°F is a significant improvement where vegetation response has been very slow
Spanish Creek - Greenhorn Creek (Farnworth property) Geomorphic channel reconstruction and re-vegetation	0.75/20	\$150,000 1991	Pre-restoration: 2 trout captured in 408' of project area.	No data available	Decreased erosion; increase in recreational fishery; Terrestrial and riparian vegetation and wildlife habitat improved;	

*Data provided on this table are from various monitoring files housed by FR-CRM, PG&E, DWR, DFG and antidotal observations.

¹Fishery benefits are based on results of electro-fishing, and are highly variable due to other variables such as flow, precipitation, and air temperatures.

² Monitoring efforts on these projects were largely limited to one year pre-project and one year post-construction measurements to confirm conformance to construction specifications. Long-term, consistent monitoring will be necessary to measure water temperature improvements in meadow re-watering projects (see Appendix C). Water temperature improvements appear to be expressed when additional groundwater stored as a result of the project begins to augment the surface water, downstream of the actual project work. Detecting change may require more sampling points both within and downstream of the project area to capture water temperature changes.

Priority 1 Project Reaches: Estimated Costs¹ and Anticipated Benefits²

<u>Stream Name/Phase Project Type</u>	<u>Total Area to be Treated – Miles/Acres</u>	<u>Estimated Costs/Completion Date</u>	<u>Anticipated Fishery Benefits</u>	<u>Anticipated Water Temperature Benefits</u>	<u>Other Benefits Anticipated</u>	<u>Comments</u>
Last Chance Creek/Mainstem Phase II Meadow Re-watering	9.0/800	\$2,800,000 2007 thru 2009	Trout fishery expected to increase, with most benefits taking up to 5 years	Maximum daily temperatures expected to decrease by up to 10°F at Doyle Crossing	Increased water storage; Terrestrial, aquatic, and riparian vegetation and wildlife habitat improved; increased riparian and meadow productivity; decreased erosion.	Improvement in temperature will be due to increased off channel water storage and delayed summertime release
Last Chance Creek/Clarks Creek Phase II Meadow Re-watering	1.0/70	\$100,000 2009	No change in fishery is expected	Decrease of 1-2°F at confluence of Clarks and Last Chance creeks;	Increased water storage; Terrestrial, aquatic and riparian vegetation and wildlife habitat improved; increased riparian and meadow productivity.	Improvement in temperature will be due to increased off channel water storage and delayed summertime release
Last Chance Creek/Mainstem Phase III Meadow Re-watering	10.0/1000	\$3,000,000 2009 thru 2011	Increased trout fishery	Decrease of daily maximum water temps. By up to 5°F	Increased water storage; Terrestrial, aquatic and riparian vegetation and wildlife habitat improved; increased riparian and meadow productivity.	This area not as impaired as Mainstem Phase II, so smaller temp. benefits anticipated
Red Clover Creek/Phase I Meadow Re-watering	3.5/375	1,100,000 2005 thru 2006	Pre-restoration: one trout observed in 2004; 9 trout observed in 2005 Anticipate increased trout fishery;	Pre-restoration: daily maximum water temp increase of 6.3°F measured in treated area from 6/15-8/31, 2005 Post-restoration: No data available Anticipate decreased water	Increased water storage; Terrestrial, aquatic and riparian vegetation and wildlife habitat improved; increased riparian and meadow productivity; decreased erosion.	Project construction planned to begin in 2006

<u>Stream Name/Phase Project Type</u>	<u>Total Area to be Treated – Miles/Acres</u>	<u>Estimated Costs/Completion Date</u>	<u>Anticipated Fishery Benefits</u>	<u>Anticipated Water Temperature Benefits</u>	<u>Other Benefits Anticipated</u>	<u>Comments</u>
			aquatic ecosystem improvement	temperatures in same area		
Red Clover Creek/Phase II Meadow Re-watering	2.0/200	\$400,000 2008 thru 2010	Anticipate increased trout fishery	Decrease of 1-3°F through project reach.	Increased water storage; Terrestrial, aquatic and riparian vegetation and wildlife habitat improved; increased riparian and meadow productivity; decreased erosion.	
Red Clover Creek/Dixie Creek Phase I Meadow Re-watering	1.0/90	\$75,000 2005 thru 2007	Improve aquatic habitat, including trout.	Little or no change	Increased water storage; Decreased erosion. Terrestrial, aquatic and riparian vegetation and wildlife habitat improved; increased riparian and meadow productivity	Relatively small project; primary goal is to stop headcut moving upstream
Red Clover Creek/Dixie Creek Phase II Meadow Re-watering	5.0/150	\$750,000 2011 thru 2013	Unknown fishery; general aquatic habitat should improve	Expected to decrease due to increased riparian vegetation	Increased water storage; Terrestrial, aquatic and riparian vegetation and wildlife habitat improved; increased riparian and meadow productivity; decreased erosion.	Limited benefits expected due to small size of watershed
Red Clover Creek/Dixie Creek Phase III Meadow Re-watering	7.0/1000	\$1,050,000 No construction date identified	Expect cumulative fishery benefits from all three phases	Decrease in maximum daily temp. of 10-15°F at Notson Bridge from all three phases of project	Increased water storage; Terrestrial, aquatic and riparian vegetation and wildlife habitat improved; increased riparian and meadow productivity; decreased erosion.	
Indian Creek/Genesee Valley	6.0/200	\$2,400,000 2006 thru 2012	Expect improved trout biomass of	Up to a 10°F decrease in maximum daily	Increased water storage; Terrestrial, aquatic and riparian vegetation and wildlife habitat	

<u>Stream Name/Phase Project Type</u>	<u>Total Area to be Treated – Miles/Acres</u>	<u>Estimated Costs/ Completion Date</u>	<u>Anticipated Fishery Benefits</u>	<u>Anticipated Water Temperature Benefits</u>	<u>Other Benefits Anticipated</u>	<u>Comments</u>
Geomorphic channel and revegetation			30% above Flournoy Bridge from 2003 levels (2,350 ml/100 yds) and 100% at Taylorsville (365 ml/100 yds)	temperatures from all Last Chance and Red Clover projects through Genesee Valley	improved; increased riparian and meadow productivity; decreased erosion.	
Indian Creek/Indian Valley Geomorphic channel and revegetation	7.0/170	\$2,800,000 2008 thru 2015	Anticipate increased trout fishery	Maintenance of the 10-15°F decrease accomplished by upstream restoration projects	Increased water storage; Terrestrial, aquatic and riparian vegetation and wildlife habitat improved; increased riparian and meadow productivity; decreased erosion.	
TOTALS	50/3780	\$13,525,000				

¹ All costs are estimates in today’s dollars. Costs reflect only survey, design, permitting and construction expenses.

² Anticipated benefits are based on professional judgment and past experience with similar projects.

Priority 2 Project Reaches: Estimated Costs¹ and Anticipated Benefits²

<u>Stream Name/Phase Project Type</u>	<u>Total Area to be Treated – Miles/Acres</u>	<u>Estimated Costs/ Completion Date</u>	<u>Anticipated Fishery Benefits</u>	<u>Anticipated Water Temperature Benefits</u>	<u>Other Benefits Anticipated</u>	<u>Comments</u>
Spanish Creek – American Valley Geomorphic channel and revegetation	7.0/170	\$2,800,000 2007 thru 2009	Expect to improve trout fishery by 30% above 2003 level (115 ml/100 yds)	Decrease maximum daily temp by up to 5°F after vegetation becomes established (5 years)	Decrease sedimentation; increased terrestrial, riparian wildlife habitat	Trout improvement difficult to establish; fishing pressure an issue at this site; Benefits will be limited to near-channel area
Spanish Creek – Meadow Valley Geomorphic channel and revegetation	7.0/170	\$2,800,000 2006-2010	No change predicted	Limited or no change (1-2°F decrease)	Decrease sedimentation; increased terrestrial, riparian wildlife habitat	Presence of foothill yellow-legged frogs may limit restoration at this site. Benefits will be limited to near-channel area
Spanish Creek – Greenhorn-Chandler Geomorphic channel and revegetation	5.0/150	\$1,250,000 2011 thru 2014	Anticipate increased trout fishery	Decrease in maximum daily temp of 3-8°F from historic temps of 76 and 77°F (2003 and 2001, respectively)	Decrease sedimentation; increased terrestrial, riparian wildlife habitat	Benefits will be limited to near-channel area
Indian Creek/Lights Creek, Indian Valley Geomorphic	5.0/1000	\$1,500,000 No construction date identified	Anticipate increased trout fishery	Decrease in daily maximum temp of 10-15°F from historic temps of 84-86°F	Terrestrial, aquatic and riparian vegetation and wildlife habitat improved; increased	Project may be required to comply with RWQCB

<u>Stream Name/Phase Project Type</u>	<u>Total Area to be Treated – Miles/Acres</u>	<u>Estimated Costs/ Completion Date</u>	<u>Anticipated Fishery Benefits</u>	<u>Anticipated Water Temperature Benefits</u>	<u>Other Benefits Anticipated</u>	<u>Comments</u>
channel or meadow re-watering				(2000-2003)	riparian and meadow productivity; decreased erosion.	standards.
Indian Creek/Cooks Creek, Indian Valley Geomorphic channel or meadow re-watering	4.0/400	\$1,000,000 No construction date identified	Anticipate increased trout fishery	Unknown	Terrestrial, aquatic and riparian vegetation and wildlife habitat improved; increased riparian and meadow productivity; decreased erosion.	Project may be required to comply with RWQCB standards.
Indian Creek/Wolf Creek, Indian Valley Geomorphic channel and revegetation	3.0/90	\$1,250,000 No construction date identified	Anticipate increased trout fishery however, expect fisheries to be limited by Greenville urban runoff	Predict maintenance of upstream temp or slight increase (<1°F) through this reach	Terrestrial, aquatic and riparian vegetation and wildlife habitat improved; increased riparian and meadow productivity; decreased erosion.	Benefits will be limited to near-channel area
TOTALS	31/1980	\$10,600,000				

Administration Budget

<u>Activities</u>	<u>Funding Per Year</u>	<u>Period</u>
FR-CRM		
Project coordination, monitoring, and education	\$125,000	Years 1-15
Project coordination, monitoring, and education	\$75,000	Year 16 onward
Maintenance (5% of 1 st Priority Total)	\$16,906	Year 1 onward
Total		
Plumas County Flood Control District		
Project development, contract administration, project oversight, and coordination and planning with IRWM Partners and other entities.	\$65,000	Years 1-10
	\$35,000	Year 11 onward

- All costs are in today’s dollars. All costs are complete, “stand-alone” costs.
- Education is primarily landowner-oriented and in support of local school science programs. Education may also include the occasional production of publications and professional papers.
- The 5% maintenance costs are to fix problems from major flood events and first-winter problems that can occur before the vegetation becomes vigorous enough to protect stream banks and floodplains during the wet season. Little problems become bigger and more costly to fix later.

Historic Funding Sources

Funding Source	Funded 1990-05	% Of Total Funding
Federal Agencies		
USDA-United States Forest Service	\$467,650	7%
USDA-Natural Resources Conservation Service	\$82,500	1%
Environmental Protection Agency	\$15,000	<1%
Bureau of Reclamation	\$980,000	14%
State Agencies		
California Department of Forestry & Fire Protection	\$105,000	2%
State Water Resources Control Board	\$3,422,104	49%
California Department of Water Resources	\$920,500	13%
Central Valley Regional Water Quality Control Board	\$109,000	2%
California Department of Fish & Game	\$100,000	1%
California Department of Transportation	\$100,000	1%
California Department of Parks and Recreation	\$39,930	<1%
UC Cooperative Extension	\$2,100	<1%
County & Local Public Agencies		
Plumas County	\$234,263	3%
Plumas County Community Development Commission	\$1,900	<1%
Quincy Community Services District	\$3,800	<1%
Plumas Unified School District	\$1,600	<1%
Feather River College	\$1,600	<1%
NorCal Nevada Resource Conservation and Development	\$9,500	<1%
Private Groups		
Pacific Gas & Electric	\$352,000	5%
Landowners	\$7,710	<1%
Sierra Pacific	\$15,000	<1%
Collins Pine	\$10,000	<1%
Total	\$6,981,157	98%



Appendix B

Watershed Data Archive

Plumas County has pursued stream restoration in the higher segments of the Feather River watershed to promote cooler water temperatures and improve water quality and fish habitat. The County believes that the thermal and other ecological improvements can be maintained as stream flow travels down the East Branch to its confluence with the North Fork Feather River, providing at least two additional weeks of target temperatures in the summer. However, to fully analyze the County's proposal and evaluate the potential for off-site mitigation, existing data should be compiled in a central archive. To fully inventory and organize monitoring data from over 20 years of upper watershed improvement work, an ambitious data management system is required. Plumas County, which encompasses more than 70 percent of the Upper Feather River watershed, is willing to initiate such an effort.

A central archive of data would bring together all existing and available studies and display them in a more consistent and publicly accessible manner. This Upper Feather River watershed data archive will be aimed at showing linkages between upper watershed improvement projects and the potential thermal and biological benefits to the downstream waters of the East Branch of the North Fork Feather River and the North Fork Feather River below its confluence. Selection of potential study and restudy areas and retrospective monitoring areas and questions will be better served by this proposed data archive. This growing base of shared information would help water managers in the NFFR practice coordinated adaptive management where and when it is desirable. This increased water management coordination is one of the goals of the Upper Feather River Integrated Regional Water Management Plan.

Since the advent and institutionalization of GIS technology, it has become much easier to correlate and integrate distinct geospatial data sets to provide new and useful insights into the interaction of many geographic phenomena (e.g., land use effect on water quality, population density effect on economic development). Now that GIS is widely utilized the focus has shifted to the challenges associated with integrating these systems and managing the volumes of data that are created. Thus, the need has arisen to build what has come to be called a geospatial data infrastructure (GDI). Such infrastructures have been described as information highways linking environmental, socio-economic and institutional databases, and providing for the flow of information from local to national levels and eventually to the global community (Coleman and McLaughlin 1997). Some examples of GDIs are the California Spatial Information Library (CASIL), California Environmental Resource Evaluation System (CERES) and Sierra Nevada Ecosystem Project. Each of these GDIs incorporate regional, state, and national data from several agencies and provide that data to a greater populous.

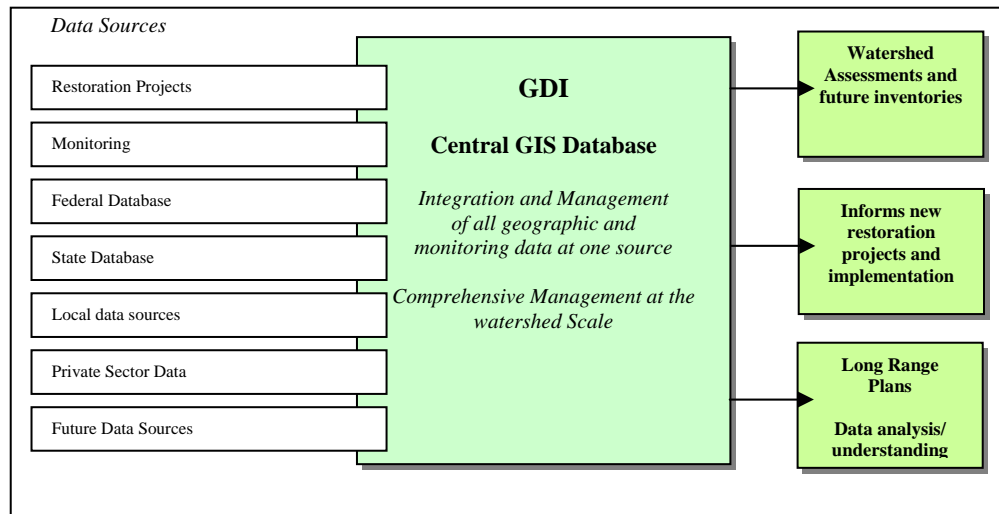
The Upper Feather River Watershed includes a large geographic area that is managed by multiple agencies, governments, private corporations and land owners, resource groups, and interested non-governmental organizations. Each of these entities creates geospatial data pertaining to their specific land holdings. Data creation by many groups means that there is a significant existing data set pertaining to the Upper Feather River Watershed. One problem with this existing data set is that it exists in unrelated and separate locations. For example, the

existing data sets are not available to greater Upper Feather River Watershed community members, nor are they integrated in a meaningful and useable context. Each entity has specific objectives for its data, and once those objectives are met, that data, often, are never used again. Another common problem with resource use data is that it is not readily shared. Usually the data creating entity is the only user of that data. This lack of coordination can lead to misunderstanding between groups, increased project costs due to redundant data gathering efforts, and an overall lack of knowledge of the resource in question due a deficiency of available data. Thus, the need for a Geospatial Data Infrastructure (GDI) has arisen within the Upper Feather River Watershed. As well, the implementation of a GDI would facilitate data sharing, reduce redundant data collection efforts, improve management decisions by providing up-to-date data, and improve efficiency for all organizations by providing a forum for data sharing.

Common Problems and Results with GIS Not Being
Linked Through a Geospatial Data Infrastructure

Common Problem	Common Result
Proprietary formats – data used by only one agency	Multiple copies of data to be managed – redundant data creation
Project / program specific data	Additional effort to process & manage data
Different map projections & datum's	Inhibits information exchange & interoperability
Not GIS ready	Poor understanding of data
Spatial & attribute data not linked	Additional cost to manage data and less robust GIS
Insufficient (or no) metadata	Inconsistent data
Inconsistent data quality	Higher risk for error
Poor decision making	No enterprise-wide data standards

A spatial server is an application that extends the relational database to handle spatial data types, thus increasing the efficiency of the database by allowing it to store and manage complex spatial data along with tabular (non-spatial) data. ArcSDE, created by ESRI, is an example of a spatial server. The third component of a GDI is GIS software. The most common GIS software is ArcGIS created by ESRI. Retrieving and manipulating data and producing maps are managed using the GIS software. Connecting to the database can be done over the web or via a restricted local network, although allowing web access enables a greater community to share the data. Beyond these three necessary components networked geospatial databases require data handling facilities, which entail a place to house the computer equipment and an administrator to manage the data, perform maintenance and update the database as new data are made available. GDIs are not simple programs that run with little human interaction. They require institutional, organizational, technological, human, and economic resources. These required components underpin the design, implementation, and maintenance of mechanisms that facilitate the sharing, access to, and responsible use of the geospatial data.



GDI schematic

The GIS data clearinghouse links past and future restoration projects and planning efforts.

Phase I Proposal

Plumas County staff would initiate the watershed archive project by meeting with resource managers in the upper Feather River Basin to obtain an understanding of the volume and quality of potentially available water related information. Available data could include unpublished data from public agencies that resource managers are interested in sharing, and unpublished reports and studies as well as published data, reports and studies by the agency. Available data also could include data, reports and studies from private entity resource managers that they were volunteering to make available to the public.

The product of this effort would be a bibliography of relevant information and a library of electronic and hard copy reports, studies and data sets. It is estimated that this effort would take about a year of 1/4 time commitment by one person and cost an estimated \$25,000, including travel and supplies. Plumas County would provide fully equipped office space and staff support and oversight.

Subsequent data management and coordination phases would be developed as part of the conclusions and recommendations from this preliminary effort and would be coordinated through the Integrated Regional Water Management partner agencies, including Plumas County, the Plumas County Flood Control and Water Conservation District, the Plumas National Forest, and the Sierra Valley Groundwater Management District. Future phases could include the development of interactive Geographic Information Systems linked through a Geospatial Data Infrastructure but we believe that it is pre-mature to propose that level of data management at this time.



Appendix C

East Branch Water Quality and Fishery Monitoring Plan

As an optional component for the Watershed Alternative, the County of Plumas suggests a water quality and fishery monitoring program to document project effectiveness.

Historically, due to limited project funding, monitoring performed by the Feather River Coordinated Resource Management Group (FR-CRM) has been largely limited to documenting for grantors and regulators that restoration projects are installed as designed and permitted – essentially “project compliance monitoring.” One to two years of data before and after the project is usually sufficient for documenting permit compliance. However, that limited monitoring is generally not enough to measure other project-related effects. Therefore, project effectiveness monitoring is proposed as a broader monitoring exercise to track other important aspects of the project, such as predicted benefits of summer stream temperature moderation and adult trout habitat improvement.

Environmental improvements usually need time to mature. For example, based on FR-CRM staff reflections on past meadow rewatering projects, it takes a minimum of three years for dewatered aquifers to refill under normal water year conditions. It takes anywhere from two to ten years for riparian vegetation to become vigorous enough to effectively shade streams and to effectively reduce streambank erosion. Trout recruitment is slow to colonize what are, in effect, isolated reaches of improved habitat in largely degraded stream systems. Restored stream reaches, because of their scarcity, can also get disproportionate fishing and hunting pressure. Fish and game species tend to concentrate in these islands of improved habitat once they are rediscovered.

The highest monitoring level proposed is on the scale of the whole East Branch of the North Fork Feather River. Project effectiveness and ambient monitoring can be integrated with watershed modeling to predict and track project responses on the scale of the full East Branch system and through a broad range of climatic conditions. This level of monitoring would be important for a better understanding of groundwater and surface water interactions and for evaluating the importance of groundwater for cold water refugia in streams during peak summer heat waves.

The monitoring plan needs to offer different levels of monitoring, depending on the kind of information desired. The data set that we have today reflects its “project compliance” monitoring purpose. In this attachment we propose different monitoring intensities with estimated budgets. We propose expanding monitoring beyond project compliance monitoring in phases, until the desired level of project effectiveness monitoring is reached.

Project Description

The Feather River CRM has been conducting watershed-wide ambient water quality and trout monitoring since 1999, under contract with the Central Valley RWQCB. The FR-CRM’s

network of sites dovetails with Plumas and Lassen National Forest monitoring efforts, so that a comprehensive and comparable data set is available for the entire watershed, on both public and private lands. In order to monitor watershed health across jurisdictional boundaries, the Feather River CRM initiated a watershed monitoring program that dovetails with the existing Forest Service watershed monitoring program, which primarily uses the Stream Condition Inventory (SCI) Protocol (USFS Region 5 1998). As a protocol that monitors stream condition, it also monitors key fish habitat parameters. The suite of protocols in SCI can also be used separately to monitor certain aspects of habitat. The entire SCI suite was developed by the Forest Service as a monitoring indicator of large-scale watershed health. The protocol is designed for use in alluvial “response reaches” of relatively small watersheds, where upstream watershed conditions are likely to trend toward stable or unstable conditions by erosional and/or depositional processes.

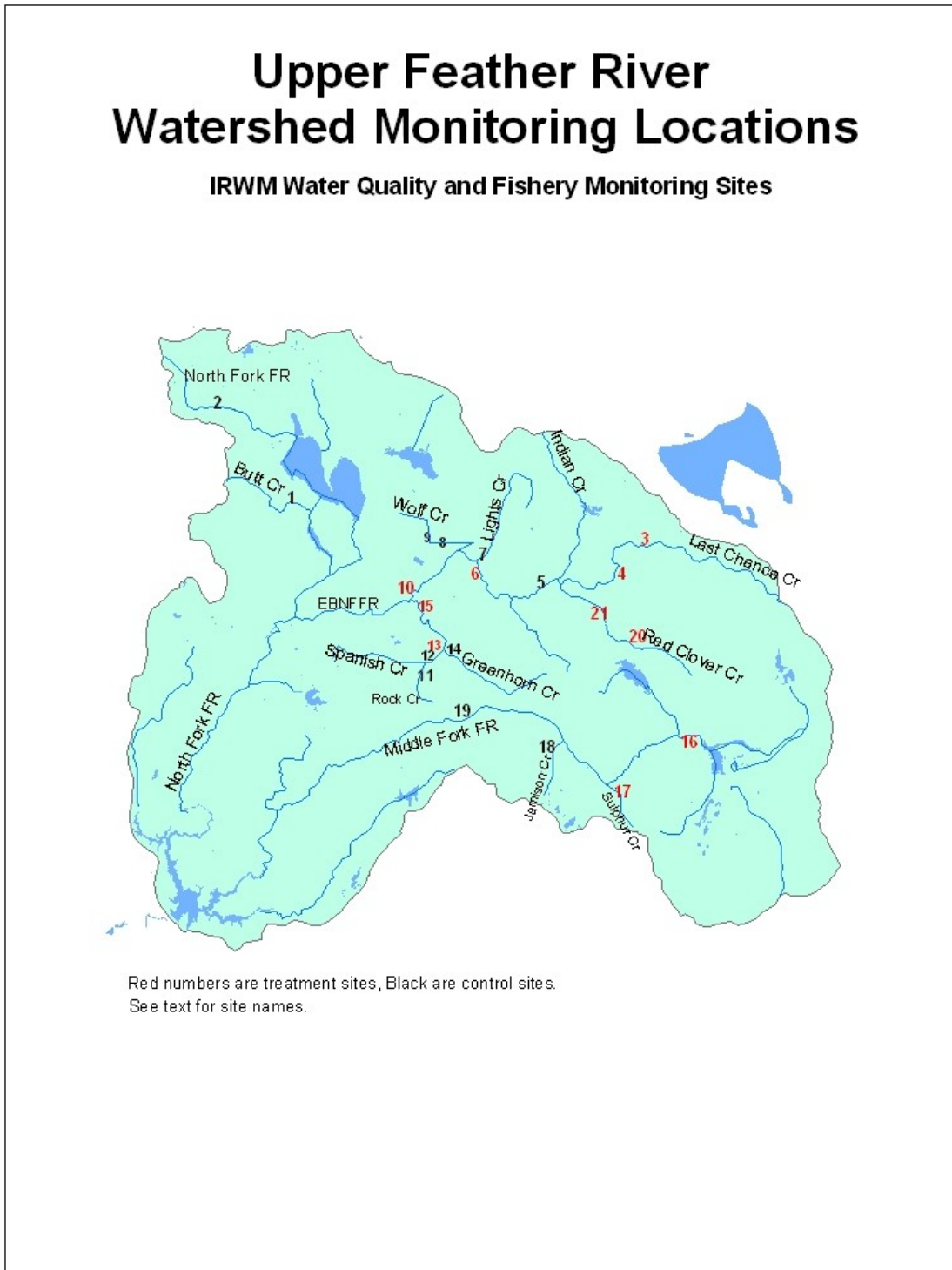
The Forest Service does not currently include fish population monitoring as part of the SCI protocol, but the Feather River CRM includes a multiple pass depletion method of fish population estimate with SCI surveys, as well as some water quality testing. The Forest Service conducts SCI surveys at each site on a five-year rotation. The CRM began with a two-year rotation for six years, and plans to continue also at five-year intervals. There are 36 Plumas National Forest Service “SCI sites” and 18 CRM “Monitoring Reach” sites. Using the same monitoring methodology for ambient monitoring and for project effectiveness monitoring facilitates the comparison and integration of monitoring data.

In the future it is proposed that all stream restoration projects include coldwater fish habitat monitoring and water temperature and flow monitoring elements. In addition it is proposed that selected past projects be resurveyed to monitor long term trends using the SCI suite plus stream temperature profiles and trout population data. In the future more of the SCI protocol data such as air temperature, stream width-depth ration, streamflow, and streamshading will accompany all project and ambient data presentations. Project monitoring is proposed to become fully integrated with ambient watershed monitoring.

Ambient watershed water quality monitoring was prioritized in the SWRCB’s State of the Watersheds - Feather River Basin, December 2002 report. This multi-level proposed monitoring program includes testing some monitoring recommendations in the Feather River CRM’s final report to the SWRCB on the first two years of the ambient watershed monitoring program (SWRCB Agreement # 00-115-150-0: 2003.) Monitoring for cold water strata in stream pools, inventorying salmonid habitat condition, and assessing salmonid habitat potential will be added to ambient watershed water quality monitoring and project monitoring.

This program would fund 4 years of measurements at 18 of the FR-CRM sites at 5 year intervals (the 36 FS sites are funded within the Forest Service). As of 2005, the FR-CRM has collected three years of baseline funding (1999, 2001, and 2003), which includes water quality and fishery monitoring in addition to the Forest Service SCI protocols. Baseline data include continuously recorded flow data from eight FR-CRM gage stations throughout the watershed, some with data from as far back as 1999, with the most recent station installed on Sulphur Creek in fall 2004. All data are available on the Monitoring Program page at feather-river-crm.org.

The following map shows all of the FR-CRM Monitoring Reach and Continuous Recording Gage Station sites.



Seven of the sites are multi- purpose sites for both ambient monitoring and also serving as baseline information for Priority 1 or 2 restoration projects, or as trend information for rotating project re-surveys. Eleven sites are primarily “single purpose” ambient monitoring or control sites. (The table below displays site names and data types as an example.)

This larger scale monitoring will complement ongoing immediate pre-project and post-project effectiveness monitoring included in each project budget and workplan, and will also help determine which parameters in the long-term monitoring program reveal measurable effects on a watershed scale.

Pre and post project data and programmatic monitoring data will be also used as model inputs for an extension of the Last Chance Creek Watershed Modeling Project down the East branch of the North Fork of the Feather River (EBNFFR) to the confluence of the EBNFFR with the NFFR in the Feather River Canyon, approximately 100 miles downstream. The water cooling effects of riparian vegetation (through transpiration and shading) and groundwater influxes to streams will also be evaluated through field measurements in combination with infra-red aerial photo monitoring. The CVRWQCB’s ambient watershed monitoring program will be significantly enriched by the monitoring information generated by implementating integrated ambient and project monitoring.

Monitoring Locations and Data Types			
Site Name & Map Number	Data Type	Treatment or Control?	Temperature Study Site?
1. Butt Cr	SCI	C	
2. North Fork Feather abv Lake Almanor	SCI	C	
3. Last Chance at Doyle X-ing	Gage Station	T	
4. Last Chance blw Murdock X-ing	SCI	T	Y
5. Indian Cr at Flournoy Bridge	SCI & Gage	C	Y
6. Indian Cr at Taylorsville	SCI & Gage	Distant T	Y
7. Lights Cr	SCI & Gage	C	
8. Wolf Cr Town Park	SCI	C	
9. Wolf Cr Main St Bridge	Gage	C	
10. Indian Cr abv Spanish	SCI	Distant T	Y
11. Rock Cr	SCI	C	
12. Spanish at Gansner Park	Gage	C	Y
13. Spanish abv Greenhorn	SCI	T	Y
14. Greenhorn Cr	SCI	C	Y
15. Spanish abv Indian	SCI	Distant T	Y
16. Middle Fork at Beckwourth*	SCI	T	

17. Sulphur mouth & Bridge*	SCI & Gage	T	
18. Jamison*	SCI	C	
19. Middle Fork abv Nelson Cr*	SCI	C	Y
20. Red Clover at Chase Br	SCI	T ¹	Y
21. Red Clover at Notson Bridge	Gage	T ¹	
¹ For Red Clover CALFED Project			

This proposal also includes new efforts, focused on increasing our understanding of cold water refugia for trout in this watershed. At ten of the monitoring reaches, additional hobotemp sensors would be placed in pool tops and bottoms, for a total of 30 pools to be measured for thermal stratification.

- What is the long-term trend of fish populations in the watershed? Continued multiple-pass depletion electroshock monitoring at the 17 Feather River CRM SCI Monitoring Reaches. Data would be compiled at the end of the monitoring cycle, and would include data from other fishery monitoring entities such as DWR at the reservoirs, the Forest Service, and the Department of Fish and Game.
- What is the long-term trend of fishery habitat in the watershed, and in response to IRWM projects? Continued five-year cycle SCI (watershed health and water quality) protocol monitoring at the 18 Feather River CRM Monitoring Reaches.

Continued operation of the CRM’s ten continuous recording flow and temperature stations. (station operation is funded through December 2006).

Additional temperature stratification monitoring of selected pools would be measured to determine whether or not pool depth provides cooler water temperatures. This would be an additional protocol to the existing monitoring regime:

Three pools in ten Monitoring Reaches (including both projects and controls), with a depth of at least twice that of the adjacent habitats, would be measured for temperature differences at the surface and at the pool bottom, and snorkeled for fish presence. Data analysis would be stratified by channel size. This protocol would begin to answer questions concerning whether or not temperature-stratified pools exist at these sites, what other channel and habitat attributes contribute to stratification, and whether or not trout use mainstem alluvial valley pools for base flow habitat.

Following is a list of the SCI parameters to be measured, with a brief explanation of their use:

- Monumented cross-sections- used to calculate erosion or deposition rates, and changes over time in bankfull cross-sectional area.
- Water quality constituents such as metals, nutrients, and physical characteristics- Provides a direct measurement of water quality for beneficial uses.

- Water and air temperature - a measurement of aquatic habitat quality, and provides an indirect measurement of riparian area management, i.e. stream shading.
- Entrenchment - used to analyze how readily high flows can access the flood plain
- Width:depth ratio, shore depth, bank stability, bank angle- used primarily to characterize stability and fish habitat quality trends, such as overhanging bank.
- Longitudinal gradient- helps provide context for interpreting other parameters
- Wolmann pebble counts - size of bed material, and changes in size over time, are a key influence in channel stability.
- Pool tail fines - Pool tails are prime habitat for spawning trout as well as aquatic insects; percent fines is a habitat quality parameter.
- Large woody debris- Important component of fish habitat cover.
- Percent shade - strong influence on water temperature.
- Pool:riffle ratio and pool depth - excessive sediment from land management in the watershed can fill pools.
- Aerial photography - provides a visual comparison of an area over time that complements the numeric data.
- Estimate fish populations- cold water fisheries are a defined beneficial use of water according to the CVRWQCB Basin Plan.
- Aquatic insect sampling and analysis- numerous indices based on insect communities can indicate changes over time in watershed health.

Budget:

Full 18 Monitoring Reach repeat should be completed every five years, at an approximate cost of \$70,000/per year, including water quality testing. Infra-red aerial monitoring will be used to complement the FR-CRM’s ambient monitoring program. Please see the FR-CRM powerpoint attachment to see an example of this monitoring protocol. In addition rotational project re-monitoring will be used to track longer-term project responses, large event responses, and the new groundwater, pool stratification, and trout population monitoring protocols beyond first year after project implementation. This proposed programmatic monitoring budget totals \$709,000 over the life of the program. (Immediate pre-and post project compliance monitoring is already included in project implementation costs).

Monitoring Costs and Schedule

Item	Year 1	Years 2, 4,7, 9, & 12	Years 6, 11 & 16
*18 Monitoring Reach full SCI protocol.	\$70,000		\$70,000
*Infra-red aerial photo water temperature baseline & trend monitoring @ \$1000/mile including	\$81,000		\$81,000

fieldwork that field verifies temperature and photo-color correlations			
Data Management & Reporting	\$5,000	\$5,000	\$5,000
Rotating Project/event Monitoring	\$4,000 project re-survey	\$4,000 project re-survey	
Rotating stream pool/groundwater temperature stratification study	\$6,000	\$6,000	
Rotating trout population survey	\$4,000 project re-survey	\$4,000 project re-survey	

In addition, the current watershed and aquifer modeling (that is described in a separate attachment about the Last Chance Phase 1 Project). could be extended downstream to the confluence with the NFFR. This highest level of monitoring would cost an additional \$500,000. This level of integrated watershed monitoring and public domain modeling would be helpful for characterizing the aquifer/groundwater characteristics in the alluvial valleys of the EBNFFR. By simulating aquifer-stream flow interactions, we would begin developing the capability to extrapolate project level water flow and temperature effects downstream, under a variety of climactic and management scenarios. If the modeling level is included, the cost in today's dollars for this proposed integrated watershed monitoring and modeling program for the EBNFFR is \$1,200,000 in today's dollars. This expenditure represents approximately 4% of overall program costs.



Appendix D

Hosselkus Creek Project Notification to Indian Creek Decree Water Rights Holders June 1, 2005

Project Description

The Hosselkus Creek project is a cooperative, multi-jurisdictional project between the Neff Family Ranch and the USDA- Plumas National Forest, Mt. Hough Ranger District (MHRD) with assistance from the Feather River Coordinated Resource Management (FRCRM) group. The project is funded by Plumas County using Monterey Agreement Water Forum funds.

The 2300-foot project would include channel and meadow restoration on Hosselkus Creek that has become deeply incised into the meadow. Approximately 1460' of the project is on lands administered by the MHRD. This degraded situation is symptomatic of meadow/channel conditions throughout the Indian Creek watershed. It has resulted in an ongoing and synergistic cycle of continuing degradation symptoms: conversion of protective meadow vegetation to sparse annual grasses and forbs, increased erosion from gully walls, loss of riparian vegetation, increased water temperatures and fluctuations, excessive in-stream sedimentation, degraded fish and wildlife habitat, etc. This action is an extension of the Hosselkus Creek Phase I Project implemented in 2002. The Phase I project was also multi-jurisdictional between the Neff Ranch and MHRD.

The treatment technique proposed in this project is called "pond and plug." This technique consists of obliterating the gully by replacing it with a series of earthen plugs and borrow pits (ponds which fill with groundwater). The excavation of the ponds provides the fill material for the plugs (see Figure 2). The flow that was within the gully is re-directed into a channel at the elevation of the meadow. Existing remnant channels are used wherever possible. However, construction of geomorphically-designed channels is sometimes necessary. The design is based on functional fluvial geomorphic processes, and has been previously implemented in numerous locations in the Indian Creek watershed, including the Phase I project. The technique was chosen here because it best meets the project objectives by restoring the functionality of the system, and has been proven to perform well, while requiring minimal long-term maintenance.

The ponds, which are situated within the gully, serve two functions. The primary function of the ponds is to provide the fill material for the gully plugs. The volume of material removed from the ponds is dictated by how much volume is needed for the plugs. An ancillary benefit of the ponds is wildlife habitat enhancement. Ponds are constructed with irregular shapes, depths, and (when feasible) islands and other wildlife components, such as perches. Because the ponds are part of the obliterated gully, surface water elevation in the ponds are generally connected only to ground water, not channel flow. Shallow groundwater levels in the Phase I project area typically fluctuate more than 15' from spring to mid-summer as the valley drains.

The plug elevations and widths are designed to reduce the risk of head-cutting and surface erosion during major overland flows. To minimize the footprint of project activities, all heavy equipment stays within the confines of the work area, and material transport generally does not exceed 300 feet. Vegetation that would be buried or drowned is removed, stockpiled, and re-planted at key points on the plugs, pond sides, or new channel where structure or support is needed.

Project Rationale & Benefits

The Feather River CRM has provided restoration project assistance to numerous landowners, public and private for almost 20 years. The evolution of our understanding of the issues facing the Feather River watershed, flooding, water quality (temperature, sediment and nutrients) and water supply reliability, has led to the direction of restoring fully functional floodplains wherever possible. General science has recognized the importance of functional floodplains for improving all of the above issues.

The meadows and valleys throughout the Feather have evolved to buffer the watershed from extremes of flood/drought and sediment/nutrient pulses from the uplands. These alluvial features spread and slow flood waters while trapping sediments and nutrients. The meadows also served as a sponge, absorbing winter and early spring flows in the porous soils, then releasing this water back into the channel through the streambanks as flows diminish into the summer.

The FRCRM has monitored a number of projects similar to the proposed Hosselkus Creek Phase II restoration, including Hosselkus Phase I. This data graphically shows the change and timing of change in shallow meadow water levels, streamflow and water temperatures from these restored meadow systems.

Figure #1 below displays the detention and release measured at Clarks Creek, which was constructed in 2001. The percentage values displayed above each annual peak level are the percent of normal precipitation for that water year. Analysis of this data reveals that the time of meadow soil saturation within 1' of ground level increased from an average of 8 days pre-project to 223 days post-project annually. Saturation to the near-surface now occurs in early winter rather than early spring. The initiation of water release is now early summer rather than mid spring. This meadow still fully releases its stored water by late summer. Streamflow from the early winter saturation point is pass-through until inflows into the meadow diminish in early summer, triggering release of soil storage. Gross recharge water available post-project over pre-project conditions in the 56 acre meadow totals 49 acre-feet using a field (water holding) capacity coefficient of .25 for sandy loam soils (USDA, 1955). As the data show, this storage is less affected by seasonal precipitation variation than the pre-project condition.

Figure #3 displays the changes occurring on Hosselkus Creek resulting from the Phase I project. The '0' line at the top of the graph is ground level. Monitoring Well # 1 is at the top of the valley and was unaffected by the original restoration work. Well #3 was near the upstream end of the Phase I work and shows some influence from the work. Well #5 is at the lower end of the valley and is fully influenced by the original work. Restoring the connection between the channel and floodplain, while reducing the erosion stress on the stream channels, allows high flows to infiltrate the upper levels of the meadow temporarily. These flows are then released later in the spring/early summer as enhanced baseflow. As the graphs show, the post project meadow soil water is higher in the spring while draining back down to pre-project levels by mid-summer.

Table #1 below displays the temperature influence of the groundwater recharge to the stream channel. These measurements were taken when surface stream flow had ceased for the season in the Hosselkus Creek Phase I project reach. Measurements were taken at the point of flow cessation upstream of the project, at the bridge where groundwater from the project area resumes surface flow and above/below the influence zone of the tributary aquifer on Indian Creek. These temperature response are consistent with monitoring that from other project areas. Cumulatively projects of this type have potential to significantly improve water temperature concerns throughout the Feather River watershed.

Photo #1 shows the existing condition downcut condition in the Phase II Reach. Photo # 2 shows the Phase I reach restored in 2002..

Table 1- Hosselkus Temperature Comparison:

Temperature Data collected on June 27, 2005. Weather mostly cloudy. Air temperature = 24.3C.

<u>Location</u>	<u>Time</u>	<u>Degrees Centigrade</u>	<u>Fahrenheit</u>
Hosselkus Cr abv the project	1355	23.5	74.3
Hosselkus Cr at bottom of project	1250	18	64.4
Hosselkus Cr at mouth	1240	21	69.8
Indian abv Hosselkus	1315	20	68
Indian blw Hosselkus	1230	19	66.2

Figure #4 illustrates the flow changes that have resulted from similar restoration in Big Flat Meadow on Cottonwood Creek. Streamflow in 1995 ended on June 6 despite being the wettest precipitation year on record.

Summary:

The meadow restoration projects implemented and being planned are intended to fully restore the water quality and baseflow augmentation functions of the naturally-evolved watershed. It was these attributes which historically made the Feather River one of the most desirable, reliable water supply river systems in California. All projects receive ongoing monitoring of some indicator of watershed function to ensure that they are performing as expected. These projects receive broad scientific, professional and governmental support because of the broad range of water resource benefits illustrated below.

Figure #1- Project Map

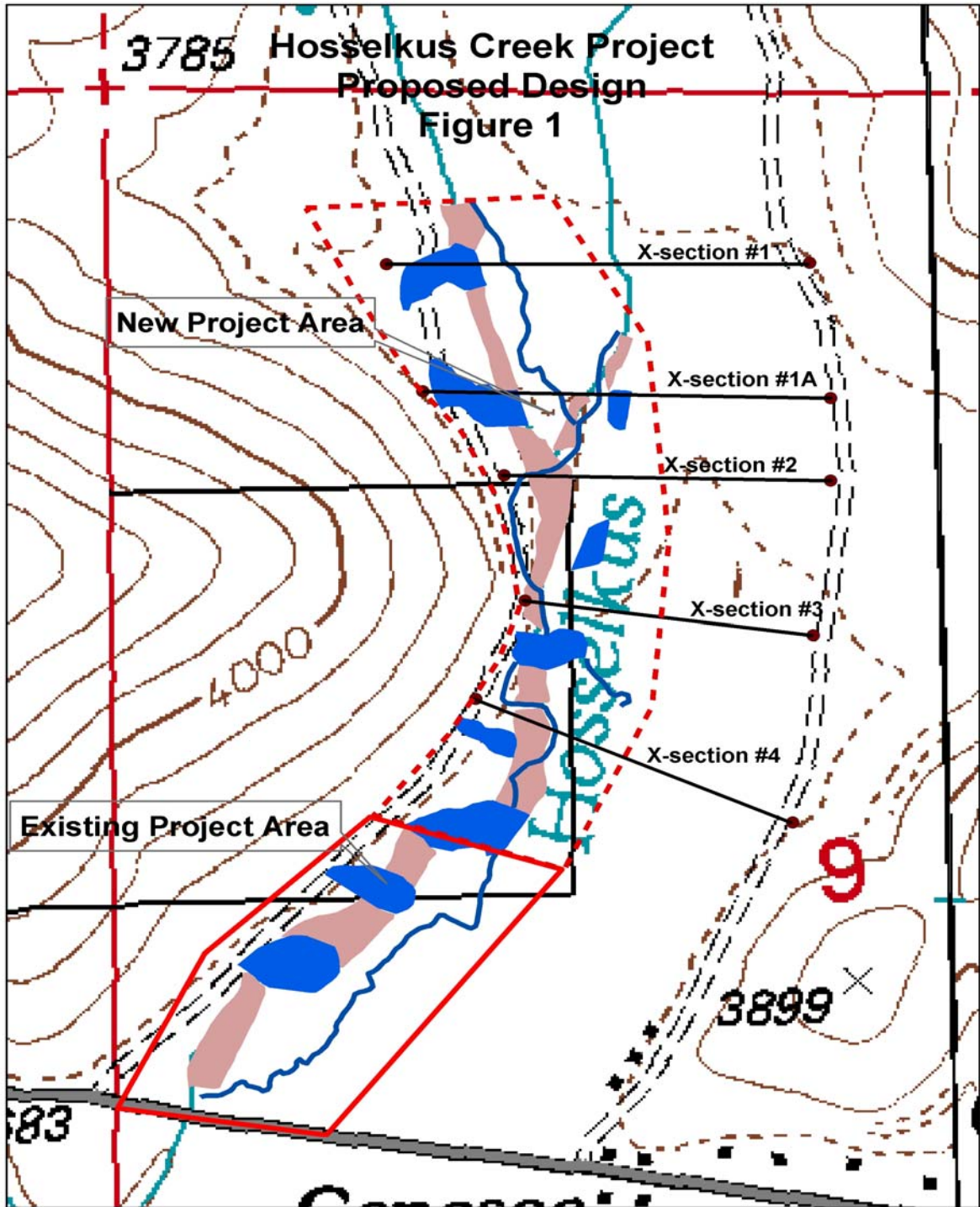


Figure #2: Clarks Creek Groundwater Data

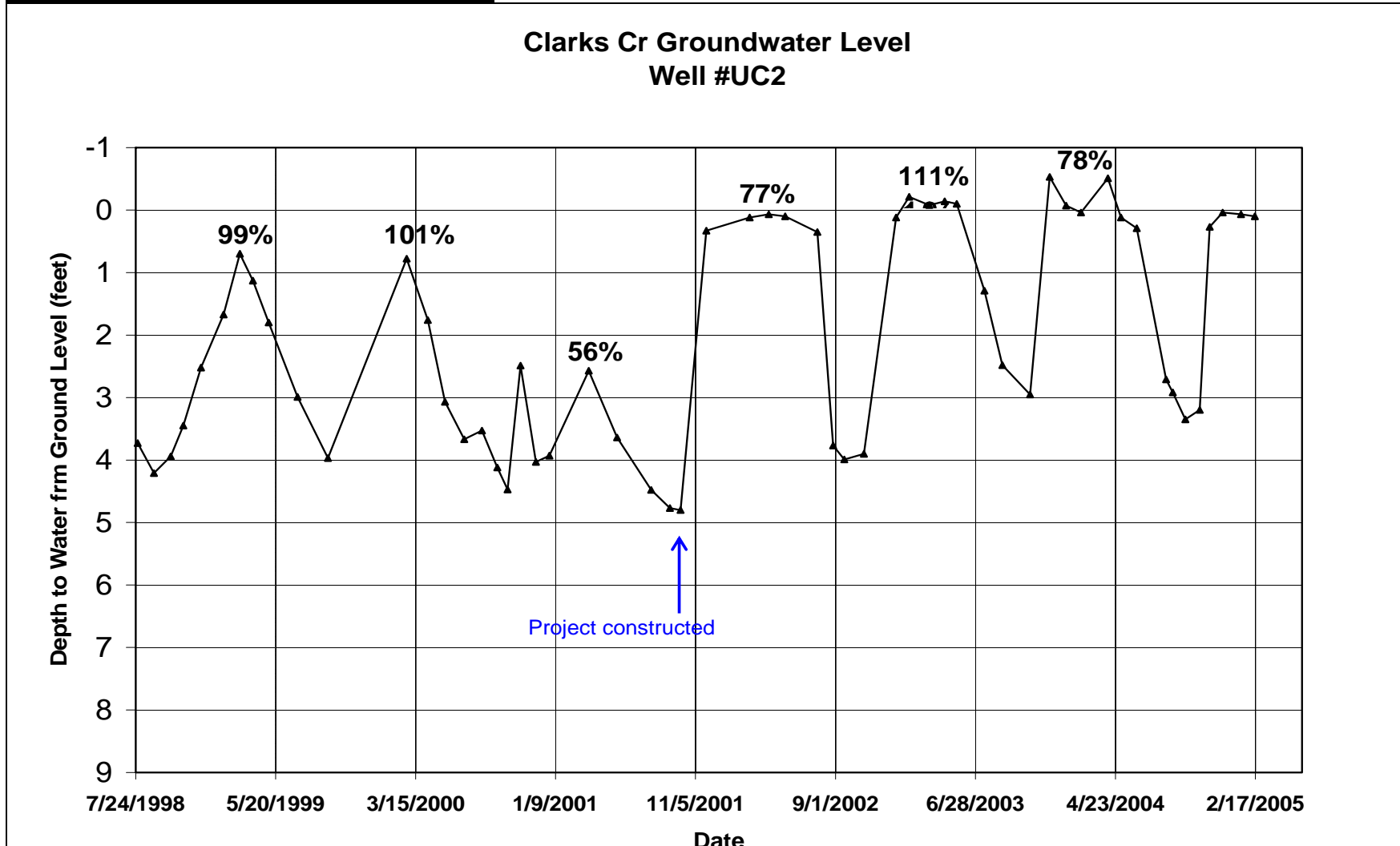


Figure #3- Hosselkus Groundwater Wells

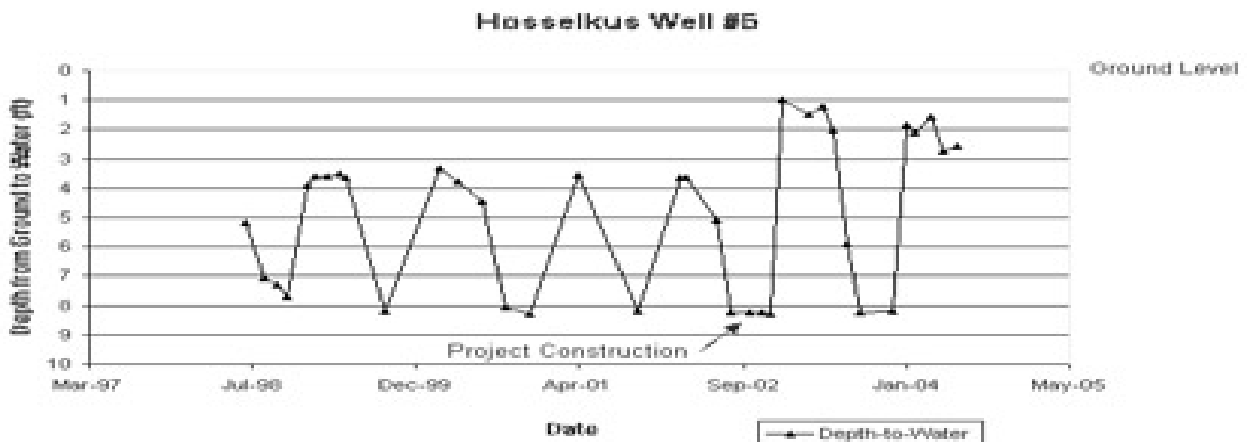
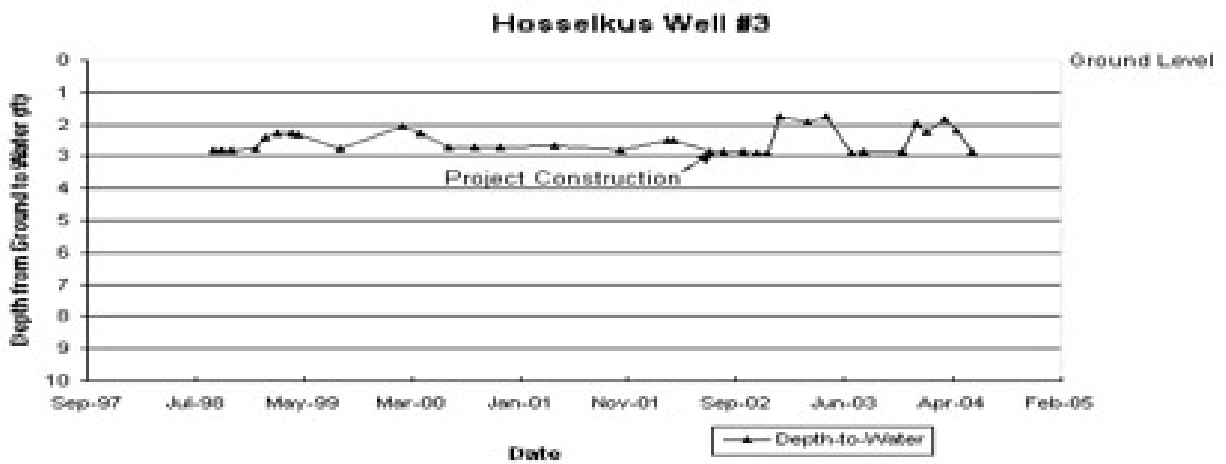
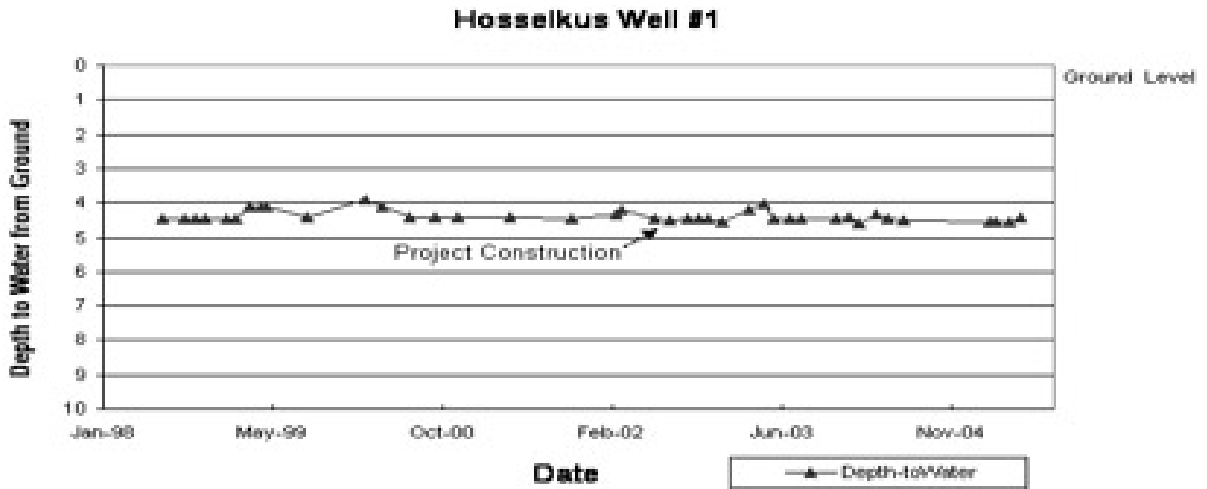


Figure #4- Streamflow Enhancement Cottonwood Creek

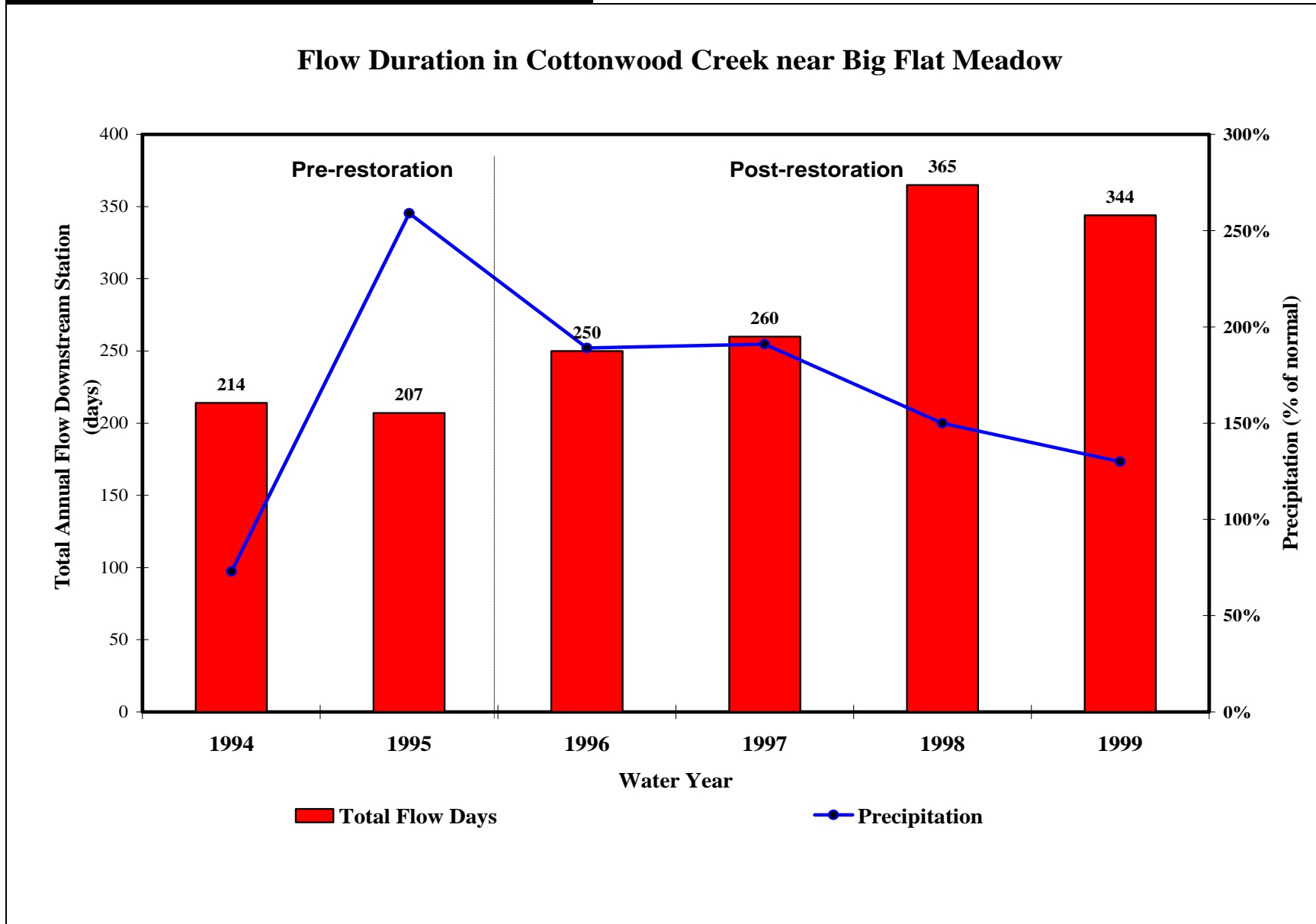


Photo #1- Hosselkus Phase II



Photo #2- Hosselkus Phase I, restored in 2002





Attachment 4

Provisions from Portland General Electric License

Article 428. Shoreline Management Plan. Within one year of license issuance, the licensees shall, after consultation with the Shoreline Management Working Group established pursuant to Article 402, file for Commission approval a Shoreline Management Plan (SMP) for the Pelton Round Butte Project. The SMP shall include standards and guidelines for new shoreline development, installation of new docks, and modification of existing docks.

The licensees shall include with the SMP, an implementation schedule, documentation of consultation, copies of comments and recommendations on the completed SMP after it has been prepared and provided to the Shoreline Management Working Group, and specific descriptions of how the Working Group's comments are accommodated by the SMP. The licensees shall allow a minimum of 30 days for the Working Group to comment before filing the plan with the Commission. If the licensees do not adopt a recommendation, the filing shall include the licensees' reasons, based on project-specific information.

The Commission reserves the right to require changes to the SMP. Implementation of the SMP shall not begin until the SMP is approved by the Commission. Upon Commission approval, the licensees shall implement the SMP, including any changes required by the Commission.

Article 429. Shoreline Erosion Plan. Within one year of license issuance, the licensees shall, in consultation with the Shoreline Management Working Group established pursuant to Article 402, file for Commission approval, a Shoreline Erosion Plan to monitor and control stream and impoundment shoreline erosion at the Pelton Round Butte Project. The plan, at a minimum, shall include the following objectives and measures listed below.

- (1) The following objectives of the plan shall be to:
 - (a) Discuss the conditions and probable causes of, as well as potential measures for, shoreline erosion;
 - (b) Describe agreed upon actions, including, but not limited to the measures described herein; and
 - (c) Provide that all actions conducted under the shoreline erosion plan shall be developed and implemented in consultation with the Shoreline Management Working Group established pursuant to Article 402.

The licensees shall develop the plan using the annotated outline in Section E-V11 – Land Management and Use of the Final Joint Application Amendment, and any other applicable information, in consultation with the Shoreline Management Working Group.

(2) Within three years of license issuance, the licensees shall commence rehabilitation at, but not limited to, the following existing erosion sites:

- (a) Chinook Island;
- (b) Indian Park Campground;
- (c) Juniper Canyon;
- (d) Big Canyon;
- (e) Dispersed sites on the east bank just south of Round Butte dam;
- (f) Shoreline of the cove at Perry South Campground and along Spring Creek;
- (g) Shoreline upstream of the Upper Deschutes Day-Use Area;
- (h) Pelton Park;
- (i) Bureau of Land Management Beach east of the Three Rivers Marina; and
- (j) shoreline and access road at Monty Campground.

(3) The licensees shall conduct, or provide for an entity to conduct, a baseline survey of the project area to identify, map, and assess existing erosion sites that are project-related and are significantly affecting terrestrial habitats, fish habitats or water quality; or that, if the site is located on the Confederated Tribes of the Warm Springs Reservation, is causing or is likely to cause significant loss of shoreline. For each erosion site identified, the licensees shall include a re-locatable topographic survey transect, notes on sediment types, vegetative condition or fish or wildlife habitat existing on the site, photographic documentation, and an analysis of the probable causes of the erosion.

(4) Beginning in the first year following license issuance, and after consultation with the Shoreline Management Working Group, the licensees shall conduct annual monitoring of the project area to monitor existing erosion sites and identify and map any new project-related erosion sites. This annual monitoring shall follow the pattern and standards established by the baseline survey performed above and shall include the opportunity for the Shoreline Management Working Group to accompany the licensees' survey crew in the field. Information that is unchanged from any prior year's survey shall be noted, but need not be repeated. Annual monitoring of sites shall occur until documentation of stable or improved conditions, after which additional monitoring can be changed based on consultation with the Shoreline Management Working Group and Commission approval. Annual monitoring shall also include an assessment of ongoing mitigation activities.

(5) No later than March 31 of each year after Commission approval of the Shoreline Erosion Plan, the licensees shall file with the Commission an annual report, prepared after consultation

with the Shoreline Management Working Group, which identifies soil erosion control measures; describes annual maintenance of erosion control sites; identifies any other soil erosion control measures including those undertaken during emergency situations; describes coordination with other resource management plans, such as the Cultural Resources Management Plan required by Article 429 of this license; and documents consultation. Any proposed changes in the treatment or monitoring status of the erosion control site shall include the rationale for such changes.

(6) Further, the licensees shall monitor identified erosion sites following (i) any event at the Round Butte development where the outflow exceeds inflow by more than the maximum turbine flow, (ii) any drawdown of Lake Simtustus resulting in 7 or more feet of reservoir elevation change in a 24-hour period, or (iii) other events that could rapidly change the shoreline condition.

(7) The licensees shall develop site-specific measures for the erosion sites listed in (2) above, and for any project-related erosion sites identified during the baseline survey or subsequent annual monitoring. The licensees shall give preference to “soft” erosion control techniques including, bioengineering, planting and seeding of appropriate native riparian species, sediment replenishment, or anchored woody debris, but may, when necessary, utilize “hard” erosion control, including use of geotextiles, rock armoring, or other hard surfaces. The licensees shall develop the site-specific measures after consultation with the Shoreline Management Working Group.

The licensees shall include with the plan, an implementation schedule, documentation of consultation, copies of comments and recommendations on the completed plan after it has been prepared and provided to the Shoreline Management Working Group, and specific descriptions of how the Working Group's comments are accommodated by the plan. The licensees shall allow a minimum of 30 days for the Working Group to comment before filing the plan with the Commission. If the licensees do not adopt a recommendation, the filing shall include the licensees' reasons, based on project-specific information.

The Commission reserves the right to require changes to the plan. Implementation of the plan shall not begin until the plan is approved by the Commission. Upon Commission approval, the licensees shall implement the plan, including any changes required by the Commission.

Appendix E

Rough Designs and Cost Estimates for Water Temperature Measures

ROUGH DESIGNS AND COST ESTIMATES FOR WATER TEMPERATURE MEASURES

The purpose of this report is to describe the methods, assumptions, and resulting rough designs and cost estimates for measures to reduce water temperature along the NFFR. The measures covered include those comprising the initial Level 2 water temperature alternatives. These rough designs and cost estimates form the basis for the design layouts and cost estimates for the water temperature alternatives presented in Chapter 5 which were used to support Level 2 screening. They should be considered preliminary and subject to change based on further detailed analysis and design. They were prepared to a level rigor and detail deemed appropriate for project planning and for purposes of this Level 1 and 2 Report.

The rough designs and cost estimates relied heavily on information provided by PG&E. This information included the following:

- Evaluation of Additional Alternative to Provide Cooler Water to the North Fork Feather River/ Pipe Yellow Creek Water Alternative (PG&E 2005c)
- Evaluation of Additional Alternative to Provide Cooler Water to the North Fork Feather River/ Mechanical Water Chillers Alternative (PG&E 2005d)
- Evaluation of Additional Alternative to Provide Cooler Water to the North Fork Feather River/ Mechanical Cooling Tower Alternative (PG&E 2005e)
- Prattville Intake Modifications Phase 3 Feasibility Study, Final Report (Black and Veatch 2004a)
- Prattville Intake Modifications Closeout Status Memorandum (Black and Veatch 2004b)
- North Fork Feather River Yellow Creek Diversion Cooling Water Pipeline Feasibility Study, Summary Report (Black and Veatch 2005a)
- Poe Tunnel Adit Feasibility Study/ Pre-Feasibility Level Sizing and Cost Estimate Summary Memorandum (Black and Veatch 2005b)
- Flow Improvement Modifications/ Plan & Sections/ Canyon Dam Intake Tower (Black and Veatch 2007)
- Miscellaneous design drawings of NFFR hydropower facilities provided by PG&E

DESIGN METHODOLOGY AND ASSUMPTIONS

- Site Selection for Facilities and Conduit Alignments

Sites for facilities and conduit alignments were selected with the objective to simplify construction and minimize construction cost. USGS 7.5 minute topographical maps, aerial photos and other information provided by PG&E were examined during the site/alignment selection process.

Sites for diversions and conduit alignments were selected to produce maximum head in order to reduce conduit size and construction costs.

- Conduit Materials

Conduit materials were as chosen based on the lowest cost material that would offer the best performance for a given application. In general, high density polyethylene (HDPE) was used for underwater conduit applications; black steel pipe (BSP) was used where flexibility was required due to site conditions with the potential for land movement; and reinforced concrete pipe (RCP) was used where site conditions would allow because of its low cost and long life.

- Diversion Structures

Inflatable rubber dams were used for stream diversions because their capability to deflate and allow for pass-through of flow, sediment, debris, and fish passage addressed concerns about establishing permanent instream barriers.

- Dredging

Dredging of the reservoir bottom using a dredging rig was required for excavating submerged channels and for preparing reservoir bottoms for setting and anchoring conduits. The dredging material was assumed to be soft, unconsolidated lake sediments. This assumption may need to be modified if Level 3 investigations reveal that the reservoirs along the NFFR have sediments mainly consisting of rocks that are markedly different.

- Modifications or Connections to Existing Hydropower Structures

Several modifications or connections to existing hydropower structure were included in various measures, as follows:

- Three 13' x 9.5' reinforced concrete boxes were attached to the face of the Butt Valley PH discharge outlet and carry flow 1,150 feet to the proposed regulating pond.
- A concrete regulating basin was attached to the face of Bucks Creek PH discharge to regulate the bypass flows and overflow into the North Fork Feather River.
- Gates #1 and #5 of the three low-level outlet gates at Canyon Dam Intake Tower were modified by connecting two pre-fabricated steel bulkheads with built-in slide gates to the existing outlets to enable controllable releases up to 600 cfs.
- Several submerged pipes were connected to existing outlets of dams.

The feasibility of these modifications and connections will require further investigation.

- Thermal Curtains

The fixed U-shaped “long upper curtain” at Prattville Intake designed by Black and Veatch (2004a) was used as the main basis for the designs of the Caribou Intake and Belden PH Intake thermal curtains.

The fixed Γ -shaped upper curtain was selected for the Caribou Intake and Belden PH Intake thermal curtains to allow free flows to the spillways at Butt Valley Dam and Belden Dam.

- Water Chillers

The following criteria were used for selecting appropriate sites for chillers:

- 1) Close to upper end of the reach or near the dam;
- 2) Warm reservoir water could be conveyed to the chillers by gravity and the chilled water could be returned by gravity back to the reach just below each dam;
- 3) Adequate open land space above the estimated flood plain;
- 4) No open land space along the Cresta reach was found to be available for deployment of multiple chillers; therefore, a constructed deck was proposed.

- Other Design Features

A submerged diffuser was proposed for all cold water plunging discharge outlets. The diffuser was designed to distribute the discharge in a larger cross sectional area for the purpose of reducing discharge velocity, turbulence and, hence, mixing.

ROUGH COST ESTIMATE METHODOLOGY AND ASSUMPTIONS

Rough cost estimates considered capital cost, annual operation and maintenance (O&M) cost, and annual foregone power generation loss.

Capital cost estimates were developed based on unit costs given in Means 2007, budgetary quotes from vendors, and cost derived from Black & Veatch estimates and Stetson databases. A 35% add-on for contingency/unlisted items and a 25% add-on for design and project management costs were used in the capital cost estimates.

To allow for comparison of costs across water temperature alternatives, capital costs were amortized and converted to an equivalent annual cost based on an interest rate of 3% and useful lives that varied depending on the capital component. New facilities, such as thermal curtains¹, diversion dams, bypass pipelines, constructed or modified low-level outlets, dredged channels, and water chillers, were assumed to have a useful life of 50 years.

Annual O&M costs were estimated to be a percentage of capital costs. The breakdown of percentages is listed in the following table:

¹ The Hypalon fabric used for thermal curtain applications, is a reinforced flexible geomembrane, a synthetic rubber product manufactured into plies that are combined over a reinforcing polyester scrim fabric. It has a demonstrated long life in harsh environments such as industrial wastes, sewage lagoons, and reservoir linings. It resists flexural cracking and abrasion as well as damaging effects of weather and heat.

Percentages Used in Annual O&M Cost Estimates

Facility	O&M Percentage of Capital Cost
Thermal Curtain	1.00%
Bypass Pipeline	0.25%
Low-Level Outlet	0.50%
Dredged Channel	1.00%
Water Chiller	3.00%

PG&E is a net importer of power, so any forgone power generation resulting from any particular measure must be replaced by purchased power from an outside supplier. Annual foregone power generation loss was estimated based on the potential commensurate flow reduction and/or turbine efficiency reduction in each respective powerhouse resulting from a particular measure², static head of the powerhouse, and normal operating efficiency of the powerhouse turbines. The unit purchase price of \$0.065/KWh was used in the foregone power generation estimates. The following table lists static heads and turbine efficiencies that were used in the foregone power generation loss estimates.

**Powerhouse Static Head and Turbine Efficiency
Used in Foregone Power Generation Loss Estimates**

Powerhouse	Static Head (ft)	Turbine Efficiency
Butt Valley PH	362	80.6%
Caribou #1 PH	1,151	69.1%
Caribou #2 PH	1,150	84.2%
Belden PH	770	79.6%
Rock Creek PH	535	85.9%
Cresta PH	290	80.1%
Poe PH	488	78.6%
Bucks Creek PH	2,558	78.1%

² The measure of reduced Butt Valley PH discharges was assumed to have no power generation loss since the water would still be stored in Lake Almanor for power generation at a later time, although it is acknowledged that the power price would be higher during the peak summer demand season compared to other non-peak seasons. The measure of increased Grizzly Creek release was assumed to result in a commensurate decrease in the Cresta Dam release (or commensurate increase in Cresta PH discharge) since the minimum instream flow is required at the location just below Grizzly Creek confluence with the NFFR. Note that in addition to the minimum instream flow requirement at the location below Grizzly Creek confluence with the NFFR, Cresta Dam has a minimum release requirement of 100 cfs.

Measure Name: Prattville Intake Thermal Curtain and Dredging

Applicable Alternative Category(s): 2a, 2b, 3, 4a, 4b (Note: Dredging excluded in Alternatives 4a and 4b)

Description of Measure: Install a U-shaped “long upper curtain” at Prattville Intake (referred to as curtain #4 in Black and Veatch, 2004a) and dredge the lake bottom to remove levees near the intake area to enhance cool water flow into the intake. The purpose of the thermal curtain is to create a barrier that prevents the flow of warm surface water into the intake. Warm water is retained behind the curtain while cool water is drawn into the intake from the lake bottom through the open area under the curtain.

Description of Operations: This measure does not affect operations. Implement normal operations at Prattville Intake and Butt Valley PH.

Detailed Description of Facilities Improvements and Design Criteria:

To be effective, the curtain must be designed such that the velocities in the open area under the curtain are relatively low, in the range of 0.10 - 0.25 fps. This objective is achieved with a Hypalon fabric curtain approximately 2,570 ft long by 50 ft deep (total area = 108,000 sq ft) extending about 900 ft offshore from the high shoreline. The curtain is “fixed,” meaning that as the lake level fluctuates the level of the lower lip of the curtain, which is set about 5 ft above the lake bottom, remains constant with respect to the lake bottom. In this way, the total open area under the curtain is maintained at the required 5,280 sq ft. Galvanized steel bin-type walls extend about 300 ft offshore from the shoreline and connect to the curtain endpoints. To enhance cool water inflow into the intake, submerged levees that impede cool water flow are removed by dredging about 23,000 cy of lake bottom material comprising the levees.

List of Figures:

- General location map of Prattville Intake thermal curtain
- Plan view of Prattville Intake thermal curtain site layout
- Elevation views of Prattville Intake thermal curtain

Discussion:

Black and Veatch prepared reports documenting the design and estimated cost for the thermal curtain at the Prattville Intake (Black and Veatch, 2004a, 2004b). Stetson evaluated the design and estimated cost documented in the Black and Veatch reports.

Evaluation of Black and Veatch design

The design size and layout of the fixed U-shaped “long upper curtain” at Prattville Intake in the Black and Veatch 2004 reports were based on results of physical prototype hydraulic model testing at the Iowa Institute of Hydraulic Research (IIHR, 2003). IIHR evaluated six thermal curtains of different sizes and layouts and conducted physical prototype model tests to compare and select the most effective and viable thermal curtain.

The most effective thermal curtain configuration was determined to be U-shaped, 900-feet x 770-feet x 900-feet (i.e., curtain #4). The most effective elevation of the curtain bottom was determined to be 4,455 ft (USGS datum). According to IIHR (2004), with the U-shaped long upper curtain in place and with the dredging of submerged levees at the Prattville Intake area, the Butt Valley PH discharge water temperature could be reduced by about 5.8°C and 5.2°C during July and August respectively at its normal operating discharge of 1,600 cfs. Dredging alone provides about 1.4°C and 1.6°C water temperature reduction at the Butt Valley PH during July and August respectively at its normal operating discharge of 1,600 cfs. IIHR also evaluated the effectiveness of installing a submerged hooded pipeline at the existing Prattville Intake to cause colder water to enter the intake. The thermal curtain measure was determined to be more effective.

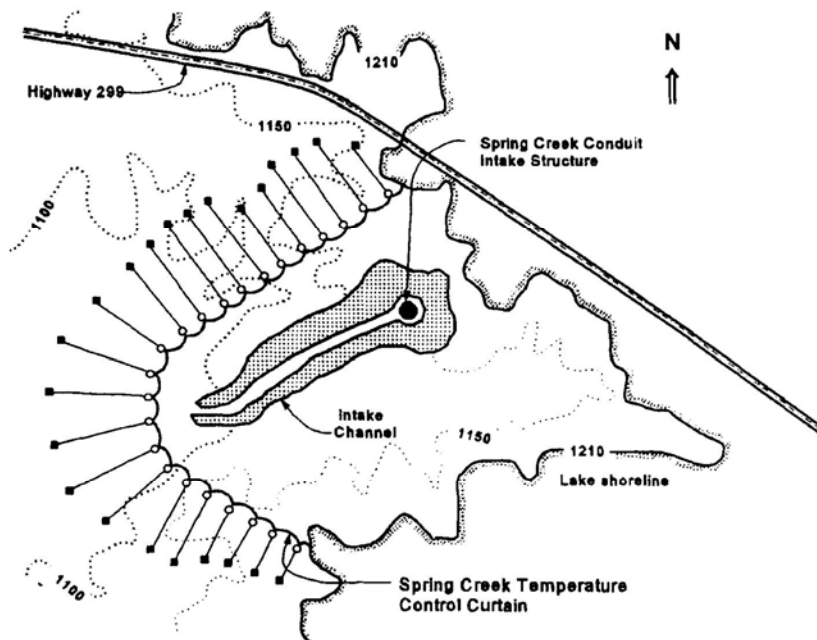
Stetson concludes that the basis of designing the fixed U-shaped “long upper curtain” at Prattville Intake for controlling the temperature of water entering the intake is technically-sound and acceptable.

Evaluation of Black and Veatch cost estimate

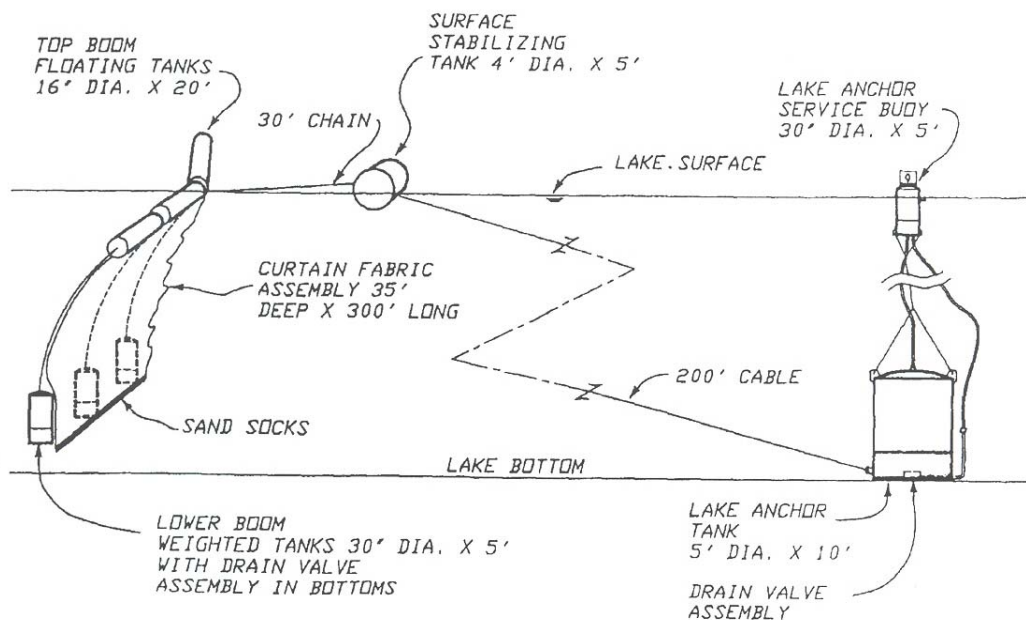
Initially, Black and Veatch estimated the cost of the “long upper curtain” (2,570 ft) and dredging at \$8.3 million (2004a). After meeting with PG&E staff and discussing the report and design assumptions, Black and Veatch modified the design to strengthen the curtain against large wave forces and revised the estimated cost to about \$17.8 million (2004b). The revision to the estimated cost was due to the modified design, changes in disposal site for the dredging material and other dredging-related costs, changes to costs for scuba diving for installation, prolonging of the construction schedule, and an increase in contingency from 25% to 35%.

At first glance, the Black and Veatch estimated cost for the Prattville thermal curtain appears to differ markedly from the actual cost of a thermal curtain of similar length installed by the Bureau of Reclamation. This difference was investigated as a way of evaluating the reasonableness of the Black and Veatch cost estimate.

In 1993, Reclamation installed thermal curtains at Whiskeytown and Lewiston Lakes in connection with the Whiskeytown Spring Creek Tunnel Intake and the Carr Powerplant tailrace. A report prepared by Tracy Vermeyen of Reclamation describing the nature of the work can be found at the following web address: http://www.usbr.gov/pmts/hydraulics_lab/tvermeyen/asce95m/index.html. The Spring Creek Tunnel Intake thermal curtain is a 100 ft deep, 2,400 ft long surface-suspended curtain which encloses the Spring Creek Tunnel intake. The curtain is surface-suspended, meaning that when the reservoir level drops the elevation of the bottom of the curtain also drops (see the following figure). In addition, the ends of curtain are anchored to shore so that when the water level drops the curtain gathers along the exposed reservoir shoreline. Installation took 4 months to complete at a cost of \$1.8 million in contractor labor and materials.



Location map of the Spring Creek Tunnel intake curtain, Whiskeytown Reservoir, California (not to scale).



- Elevation view of a typical temperature control curtain and its structural components.

Plan and Elevation Views of Reclamation's Thermal Curtain at Spring Creek Tunnel Intake (Source: Bureau of Reclamation 1997)

Mr. Greg O'Haver, former Reclamation employee in charge of construction of the Whiskeytown thermal curtain project, and Ms. Tracy Vermeyen, Reclamation project engineer for the hydraulic study, were contacted to discuss the Spring Creek Tunnel

Intake thermal curtain. These discussions aided in understanding the reasons for the cost difference between the two thermal curtains.

In general terms, the primary difference between the two thermal curtains has to do with the design intent. The Spring Creek Tunnel Intake thermal curtain was designed to be temporary structure with a target useful life of 10 years. The Prattville thermal curtain, on the other hand, has been designed to be a permanent structure. While the basic functions of the two curtains are the same, the design of the permanent structure provides for a stronger and more robust curtain. This is demonstrated by the use of stainless steel for various components as well a heavier duty metal for other components.

Further specific differences between the thermal curtains follow:

- Thermal curtain design

The length of the Prattville thermal curtain is 2,570 feet compared to 2,400 feet for the Spring Creek Tunnel Intake thermal curtain. The Spring Creek Tunnel Intake thermal curtain used the same material (Hypalon fabric) as the Prattville thermal curtain.

The Prattville thermal curtain employs a fixed curtain design while the Spring Creek Tunnel Intake thermal curtain employs a surface-suspended curtain design. The fixed curtain design was selected so that when the water surface of the lake drops the opening under the curtain will remain the same and preserve the hydraulics necessary for effective cool water flow to the intake. The fixed curtain is more costly due to the added cost to anchor the system to the bottom of reservoir, which requires scuba divers and additional anchoring features.

- Strengthening for Wave Forces

At Prattville there was concern for the forces on the curtain system from wave action. This resulted in increased material costs for the cables, chains, and fasteners as well as the amount of concrete needed for the anchoring system.

- Bin Walls

The Prattville thermal curtain has galvanized steel bin walls to prevent damage to the curtain that may arise from wind, debris, and vandalism when the reservoir level declines and exposes the curtain along the shoreline. At the Spring Creek Tunnel Intake the curtain tore at the shoreline, was vandalized, and was buried by sand preventing it from floating when the lake level rose. The Black and Veatch design for the Prattville thermal curtain calls for a bin wall extending from the high water shoreline to 50-150 ft beyond the low water shoreline, where a vertical trolley system is proposed. This system allows the top of the curtain to slide up and down as the water surface varies preventing stresses in the curtain. It also prevents the curtain from being exposed and buried in the sand and discourages vandalism. This system also eliminates the periodic maintenance that would be needed to free the curtain buried by sand.

- Dredging

The Prattville thermal curtain design calls for dredging of submerged levees on the lake bottom near the intake, which was not included in the Spring Creek Tunnel Intake thermal curtain. The hydraulic study prepared by the Iowa Institute of Hydraulic Research (IIHR, 2003) based on a physical prototype hydraulic model and referenced in the Black and Veatch report (2004a) found that the levees must be removed in order to allow cool water to be drawn to the intake.

- Scuba Diving

The cost for divers to install various components of the Prattville thermal curtain is anticipated to be substantially higher than the cost incurred at the Spring Creek Tunnel Intake thermal curtain. This higher cost is due to the added complexity of the fixed curtain's anchoring system.

- Concrete

At Prattville additional concrete is needed to anchor the curtain. The cost of concrete world-wide has increased substantially since 1993 when the Spring Creek Tunnel Intake thermal curtain was installed.

The revised Black and Veatch report (2004b) placed the total capital construction, design, and other pre-construction costs of the Prattville thermal curtain at approximately \$17.8 million. In order to compare the costs of Prattville and Spring Creek Tunnel Intake thermal curtains certain itemized costs for components that were not included in the Spring Creek Tunnel Intake thermal curtain construction cost were deducted from the Prattville total cost. The costs included dredging, bin walls, and other cost items. The remaining common Prattville thermal curtain costs were adjusted to 1993 dollars to be comparable to the Spring Creek Tunnel Intake thermal curtain costs. This comparative cost analysis is summarized in the following table.

The General Requirements section (mobilization, supervision, temporary facilities and utilities, safety, and miscellaneous) for the Prattville thermal curtain accounts for slightly more than \$1 million, far less than it likely accounted for on the Spring Creek Tunnel Intake thermal curtain. The primary factor driving this cost for Prattville is the overall cost since this figure is estimated based on the scale of the project and the overall total project cost.

While the comparable costs in 1993 dollars are different they are of similar magnitude. It appears that the Prattville thermal curtain is more costly due to increased complexity and numerous other factors that differentiate it from the Spring Creek Tunnel Intake thermal curtain. Absent detailed examination of the Black and Veatch design and cost (2004a, 2004b), the Prattville thermal curtain and cost estimate, while conservative, appears to be reasonable and acceptable for use in this Level 2 analysis.

Comparison of Spring Creek Tunnel Intake and Prattville Intake Thermal Curtain Costs

Item	Spring Creek Tunnel	Prattville
Published Cost	\$1,800,000	\$17,800,000
Non-Construction Costs	\$0	-\$7,500,000 ¹
Dredging	\$0	-\$2,120,000 ²
Bin Walls	\$0	-\$1,260,000 ³
Scuba Diving	\$0	-\$640,000 ⁴
Wave Force Cost	\$0	-\$1,270,000 ⁵
General Requirements	\$270,000 ⁶	-\$1,000,000 ⁷
Prattville comparable to Spring Creek Tunnel costs	\$1,530,000	\$4,010,000
1993 Dollars	\$1,530,000	\$2,980,000 ⁸
Difference		\$1,450,000

Notes:

1. Prattville costs from Black & Veatch report (2004b) that are not construction related total \$7.5 million.
2. Total of sections 02240 and 02300 from Black & Veatch report (2004a) and rounded, not including cost of rock for bin walls (~\$120,000).
3. Sum of bin walls item in section 05100 from Black & Veatch report (2004a) and rounded. Includes cost of bin wall rock (\$120,000) from 02300 as well as line item cost for diving of \$150,000.
4. Sum of subcontract for divers items in section 02480 from Black & Veatch report (2004a) and rounded.
5. This figure resulted from the difference between the concrete and metals sections of the B&V report (2004a) (without wave force consideration) and Black & Veatch report (2004b) (with wave force consideration).
6. General requirements were assumed to be 15% of the total project cost and rounded.
7. Sum of general requirements items in Division 1 from Black & Veatch report (2004a) and rounded.
8. Adjusts the total project costs to 1993 dollars based on ENR Construction Cost Index change (1993 = ~72% of 2004). This was done by reviewing the Construction Cost index from the Engineering New Record (ENR) for the first week of June 1993 (value = 5260.23) and the first week of December 2004 (value = 7206.30) and decreasing the Prattville estimate by the percent change in the index (1993 = ~72% of 2004).

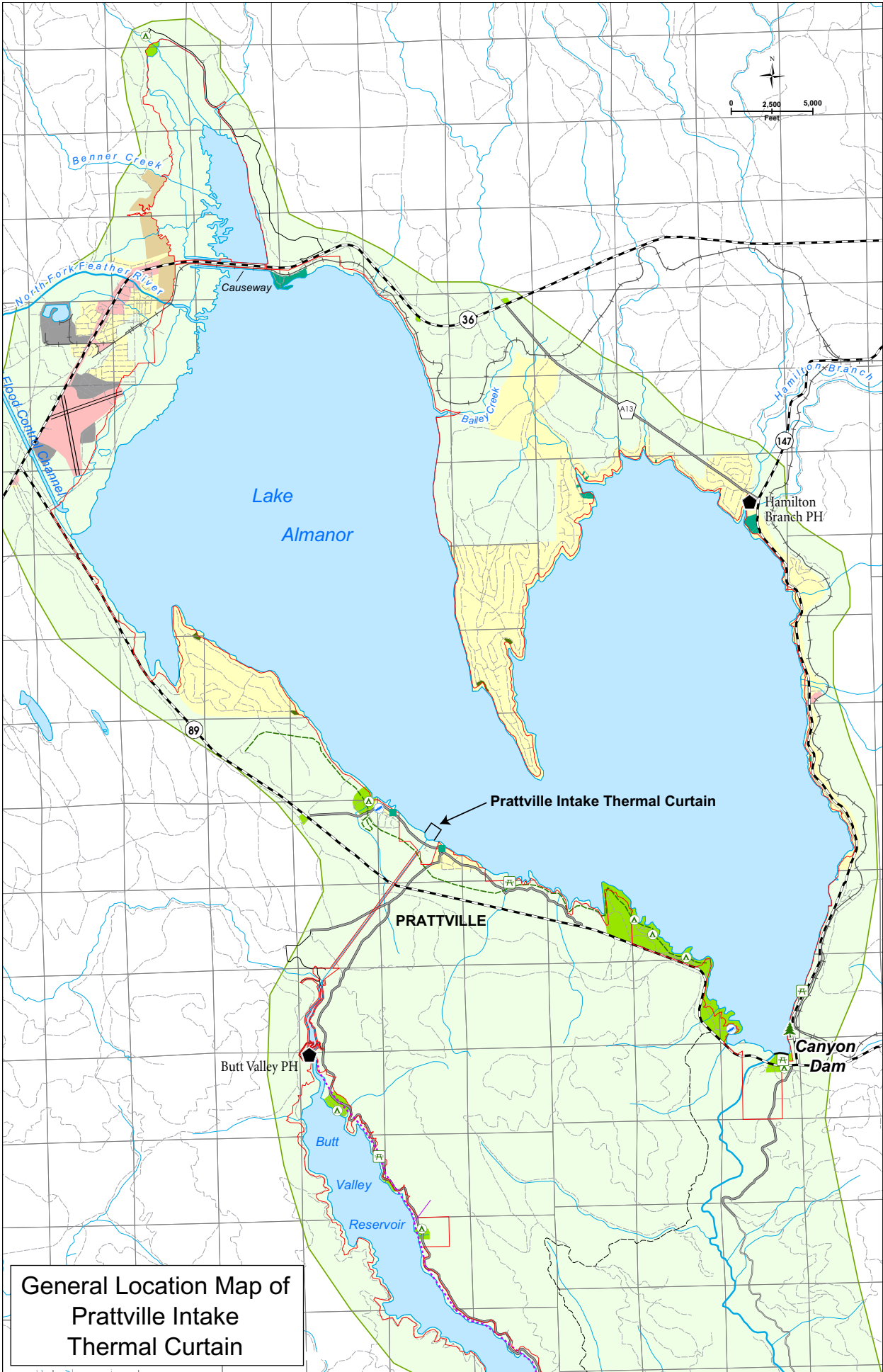
Based on the Prattville thermal curtain length of 2,570 feet and the 2004 cost of \$4.01 million, the unit cost of a thermal curtain is approximately \$1,560 per linear foot for construction only items. To adjust this cost to 2007 dollars, the percent change in the ENR Construction Cost Index was used. The previously stated ENR value of 7306.30 for the first week of December 2004 was used and the most recent available value of 7864.70 for April 23, 2007 was used. The value for 2007 is approximately 7.6% greater than the December 2004 value. The resulting 2007 unit cost is \$1,700 per lineal foot. This unit value can be used for approximating the cost of curtains at other sites constructed in a manner similar to the Spring Creek Tunnel Intake thermal curtain.

Black and Veatch Opinion of Cost of Prattville Intake Thermal Curtain #4 (2004b)

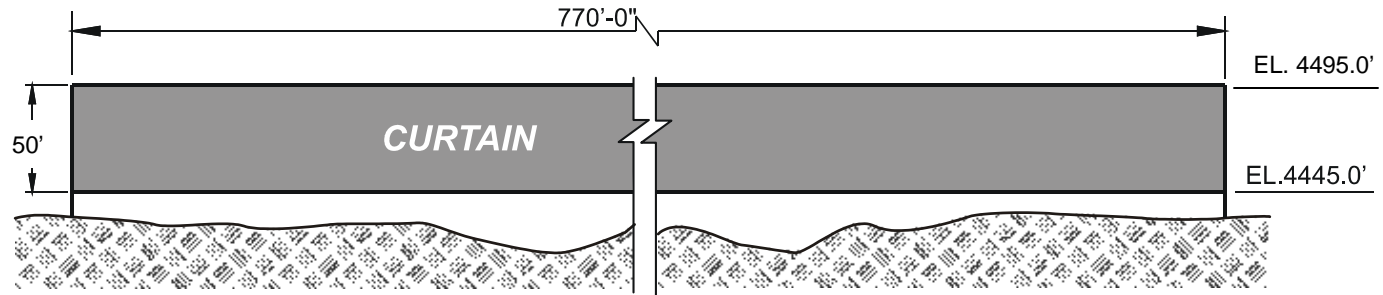
CSI Div. / Sect.	DESCRIPTION	Quantity	Unit	Unit Cost	Labor					Material		Equipment				Sub-contract	Other	Total Cost	Remarks	
					Crew Code	M-H per Unit	Man Hours	Durati on Days	Avg. Wage Rate	Labor Cost	Unit Cost	Material Cost	Code	No.	Avg. Cost (\$/hr)					Equipment Cost
1	General Requirements																			
	Mobilization	1	LS	95,515				0.0		0.00							95,515	95,515		
	Supervision	1	LS	349,638				0.0		0.00							349,638	349,638		
	Temporary construction facilities	1	LS	139,855				0.0		0.00							139,855	139,855		
	Temporary utilities	1	LS	104,892				0.0		0.00							104,892	104,892		
	Safety	1	LS	174,819				0.0		0.00							174,819	174,819		
	Miscellaneous	1	LS	139,855				0.0		0.00							139,855	139,855		
	Subtotal Mobilization									0	0				0	1,004,575	1,004,575			
2	Site Work																			
02240	Dewatering																			
	1 Decant Basin (Excavation And Restoration)	300	CY	16	H	0.246	74	0.6	58.77	4,336.88			6	4	35.53	349.57		4,686	Excavation & Demo Conc. Basin	
	1 Decant Basin (Concrete)	182	CY	249	E	1.499	273	2.3	58.77	16,041.41	112.00	20,390.22	8	2	47.66	867.38	0	8,000	45,299	Other Is Filters for Fines
02300	Earthwork																			
	1 Dredge disposal area prep	1	LS	15,000	A	0.000	0	0.0	55.00	0.00	0.00	0.00						15,000	15,000	
	1 Dredge Disposal Area Restoration	1	LS	20,000	A	0.000	0	0.0	55.00	0.00	0.00	0.00						20,000	20,000	
	1 Silt curtains	76,000	SF	1.27	C	0.004	269	11.2	48.33	12,996.00	0.89	67,640.00	3	1	96.65	8,662.91		7,300	96,599	
	1 Dredging	22,750	CY	60	A	0.448	10,200	63.8	55.00	561,000.00	0.00	0.00	1	1	294.12	375,000.20	79,000	360,900	1,375,900	Other is special mob/demob
	1 Crane	1	LS	155,373.81	B	2,040	2,040	63.8	52.00	106,080.00	0.00	0.00	3	1	96.65	49,293.81		0	155,374	Fourth Additional Crane
	2 Bin wall backfill (rock)	3,750	CY	31	A	0.000	0	0.0	55.00	0.00	31.00	116,250.00						0	116,250	
	1 Skinner Flat - Machine Loading & Hauling 5 Miles	22,750	CY	13.89	H	0.274	6,234	194.8	47.75	297,649.63			6	4	35.53	13,840.32			311,490	
	1 Skinner Flat - Level Site	22,750	CY	4.17	C	0.082	1,866	77.7	48.33	90,165.83			7	2	46.00	4,767.39			94,933	
02480	Marine Work																			
	3 Work boat	1	EA	150,000	F	0.000	0	0.0	51.75	0.00	150,000.00	150,000.00						0	150,000	
	Subcontract For Divers																			
	Curtain Anchors																			
	3 Windward Main Anchors	1	LS	271,397	E	0.000	0	0.0	56.00	0.00	0.00	0.00					271,397	0	271,397	Was \$210K Divers For 53.7 MD
	3 Leeward Main Anchors	1	LS	155,251	E	0.000	0	0.0	56.00	0.00	0.00	0.00					155,251	0	155,251	Adj. for 39.7 MD \$210K Divers
	Bin Walls																			
	3 Water Installation, Including Fill	1	LS	150,000	A	0	0	0.0	55.00	0.00		0.00	1	1	335.81	0.00	150,000	0	150,000	Subcontract for Diving
	Curtain Wall																			
	3 Hypalon Curtain (60 mils)	1	LS	210,000	G	0.000	0	0.0	49.20	0.00	0.00	0.00					210,000	0	210,000	Subcontract for Diving
	Subtotal Site Construction						20,955			1,088,270		354,280				452,782	865,648	411,200	3,172,180	
3	Concrete																			
03400	Precast Concrete																			
	Curtain Anchors																			
	4 Windward Main Anchors	1,244	CY	250	E	1.786	2,221	69.4	56.00	124,400.00	150.00	186,600.00					0	0	311,000	Caissons
	4 Leeward Main Anchors	711	CY	250	E	1.786	1,270	39.7	56.00	71,100.00	150.00	106,650.00					0	0	177,750	Caissons
	4 Chain Anchors For Bottom Of Curtain	1,444	CY	250	E	1.786	2,579	80.6	56.00	144,400.00	150.00	216,600.00					0	0	361,000	Caissons
	Subtotal Concrete						6,070			339,900		509,850				0	0	0	849,750	
5	Metals																			
05050	Basic Materials & Methods																			
	Curtain Anchors																			
	4 Windward Main Anchor Frame	33,600	LBS	2.40	B	0.012	388	12.1	52.00	20,160.26	1.80	60,480.00					0	0	80,640	
	4 Leeward Anchor Frames	24,000	LBS	2.40	B	0.012	277	8.7	52.00	14,400.19	1.80	43,200.00					0	0	57,600	
	4 Chain Anchors (For BOC) Frames	65,000	LBS	1.80	B	0.012	750	23.4	52.00	38,999.99	1.20	78,000.00					0	0	117,000	
	4 Miscellaneous	23,800	LBS	3.20	B	0.015	366	11.4	52.00	19,040.01	2.40	57,120.00					0	0	76,160	
05100	Structural Metal Framing																			
	Bin Walls																			
	2 east and west walls	8,400	sf	29	A	0.060	502	7.9	55.00	27,636.00	24.00	201,600.00	1	1	192.58	12,095.56		0	241,332	
	2 Water Installation, Including Fill	1	LS	373,975	A	3,856	3,856	60.3	55.00	212,100.00		0.00	1	1	335.81	161,874.52	0	0	373,975	
	4 Curtain cables (Galv.)																			
	4 Windward Main Anch. To Stabilizing Buoy, 1-1/4" Dia.	5,250	ft	15.63	D	0.070	368	5.7	52.88	19,431.56	11.90	62,475.00	3	0	96.65	138.97		0	82,046	

Black and Veatch Opinion of Cost of Prattville Intake Thermal Curtain #4 (2004b)
(Continued)

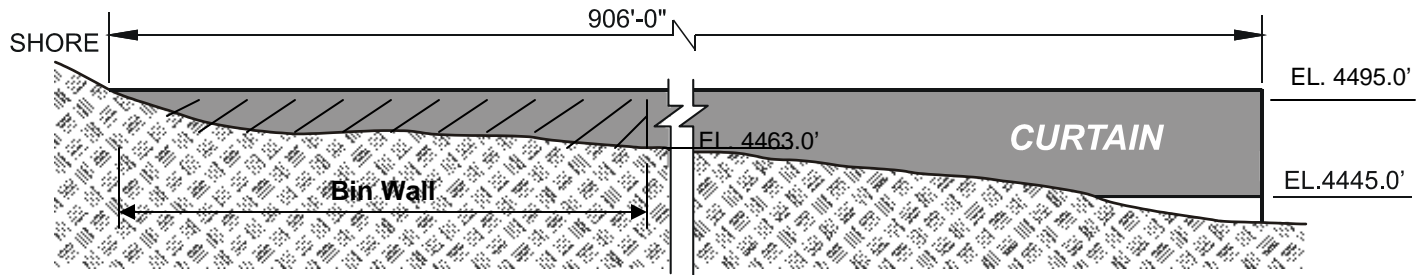
CSI Div./ Sect.	DESCRIPTION	Quantity	Unit	Unit Cost	Labor					Material		Equipment		Sub-contract	Other	Total Cost	Remarks			
					Crew Code	M-H per Unit	Man Hours	Durati on Days	Avg. Wage Rate	Labor Cost	Unit Cost	Material Cost	Code					No.	Avg. Cost (\$/hr)	Equipment Cost
4	Leeward Main Anch. To Stabilizing Buoy, 1-1/8" Dia.	4,200	ft	12.78	D	0.056	235	3.7	52.88	12,436.20	9.80	41,160.00	3	0	96.65	88.94	0	53,685		
4	Windward Main Anch. To Bottom Tanks, 7/8" Dia.	4,200	ft	8.31	D	0.033	139	2.2	52.88	7,328.48	6.55	27,510.00	3	0	96.65	52.41	0	34,891		
4	Leeward Main Anch. To Bottom Tanks, 1" Dia.	3,150	ft	10.40	D	0.046	145	2.3	52.88	7,661.59	7.95	25,042.50	3	0	96.65	54.80	0	32,759		
	Curtain chains (1" Extra Strength Galv.)																			
4	Windward Stabilizing Buoy To Top Tanks	1,050	ft	29.61	D	0.154	162	2.5	52.88	8,557.49	21.41	22,480.50	3	0	96.65	53.30	0	31,091		
4	Leeward Stabilizing Buoy To Top Tanks	1,050	ft	29.61	D	0.154	162	2.5	52.88	8,557.49	21.41	22,480.50	3	0	96.65	53.30	0	31,091		
4	Between Top Tanks	390	ft	29.61	D	0.154	60	0.9	52.88	3,178.50	21.41	8,349.90	3	0	96.65	19.80	0	11,548		
4	Between Bottom Tanks	195	ft	29.61	D	0.154	30	0.5	52.88	1,589.25	21.41	4,174.95	3	0	96.65	9.90	0	5,774		
4	Anchors To Bottom Tanks	1,950	ft	29.61	D	0.154	301	4.7	52.88	15,892.49	21.41	41,749.50	3	0	96.65	98.05	0	57,740		
4	Ropes (3/4" Polyester)																			
4	Top Of Curtain	1,750	ft	2.16	D	0.017	30	0.5	52.88	1,573.03	1.25	2,187.50	3	0	96.65	11.25	0	3,772		
4	Bottom Of Curtain	1,750	ft	2.16	D	0.017	30	0.5	52.88	1,573.03	1.25	2,187.50	3	0	96.65	11.25	0	3,772		
	Floatable Tanks																			
4	Top Of Curtain - 15' Long	132	LS	3,186	D	0.000	0	0.0	52.88	0.00	3,186	420,495.54	3		96.65	0.00	0	420,496		
4	Bottom Of Curtain - 30' Long	66	LS	5,734	D	0.000	0	0.0	52.88	0.00	5,734	378,445.98	3		96.65	0.00	0	378,446		
	Stabilizing buoys																			
4	Windward Stabilizing Buoys	21	ea	3,290	D	0.000	0	0.0	52.88	0.00	3,136.00	65,856.00	3		96.65	0.00	0	69,087		
4	Leeward Stabilizing Buoys	21	ea	3,290	D	0.000	0	0.0	52.88	0.00	3,136.00	65,856.00	3		96.65	0.00	0	69,087		
2	Trolley Beams At Ends Of Bin Wall	2	ea	17,320	D	6.998	14	0.2	52.88	740.00	13,800.00	27,600.00	1	1	742.85	1,299.55	5,000	0	34,640	
2	Duct Pipe At Ends of Bin Wall	2	ea	4,420	D	6.998	14	0.2	52.88	740.00	900.00	1,800.00	1	1	742.85	1,299.55	5,000	0	8,840	
	Subtotal Metals						7,828			421,596		1,660,251				177,161	10,000	6,462	2,275,470	
8	Doors																			
089xx	4 Curtain Wall																			
	Hypalon Or XR-5 Curtain (60 mils)	108,000	SF	6.24	G	0.046	5,020	62.7	49.20	246,960.19	2.15	232,200.00	5	4	96.75	194,250.02		1,000	674,410	
	Subtotal Doors						5,020			246,960		232,200				194,250	0	1,000	674,410	
10	Specialties																			
4	Cable Break Warning Buoys - foam	84	EA	100.00	F	0.000	0	0.0	51.75	0.00	100.00	8,400.00			0.00	0.00		0	8,400	
4	Marine Warning And Signs Around Curtain	1	LS	12,560.00	F	0.000	0	0.0	51.75	0.00	12,560.00	12,560.00			0.00	0.00		0	12,560	
	Subtotal Specialties						0			0		20,960			0	0	0	0	20,960	
16	Electrical																			
4	Off Shore Temporary Floating Lighting	1	LS	36,381						0.00	0.00	0.00			0.00	0.00	36,381	0	36,381	Subcontract Furnish and Install
1	On Shore Temporary Lighting	1	LS	29,191						0.00	0.00	0.00			0.00	0.00	29,191	0	29,191	Subcontract Furnish and Install
	Subtotal Electrical						0			0	0	0			0	0	65,572	0	65,572	
17	Instrumentation																			
4	Trash rack blockage warning system	1	EA	5,000	F	0.000	0	0.0	51.75	0.00	0.00	0.00	4	2	81.29	5,000.00		0	5,000	
	Subtotal Instrumentation						0			0	0	0			5,000	5,000	0	0	5,000	
	Construction Subtotal (Direct Costs)						39,872			2,096,725		2,777,542			829,193	941,220	1,423,236		8,067,916	
	Indirect Costs																			
	Sales Tax																			222,203
	Overhead and Profit																			1,613,583
	Bonds and Insurance																			396,148
	Escalation																			645,433
	Contingency																			3,830,849
	Construction Subtotal Indirects																			6,708,217
	Total Construction (directs and Indirects)																			14,776,133
	Permits																			50,000
	Design																			1,477,613
	Construction Management																			1,477,613
	Total																			17,781,359



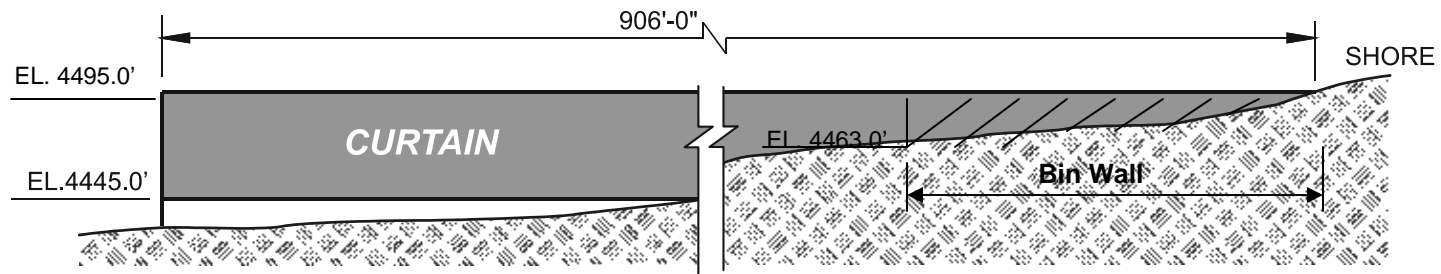
General Location Map of
Prattville Intake
Thermal Curtain



SIDE 1



SIDE 2



SIDE 3

Note: Bin walls extend from the shoreline to where the bottom of the lake is at el. 4463 ft (PG&E datum)

Elevation Views of Prattville Intake Thermal Curtain (Curtain #4)
(Adapted from Figure 7-8 of IHR, 2004)

Measure Name: Caribou Intake Thermal Curtain

Applicable Alternative Category(s): 2b, 3, 4a

Description of Measure: Install a fixed Γ -shaped “long upper curtain” near the Caribou Intakes. The purpose of the thermal curtain is to create a barrier that prevents the flow of warm surface water into the intake. Warm water is retained behind the curtain while cool water is drawn from the lake bottom into the intake through the open area under the curtain. The Γ -shaped curtain does not affect flow to the spillway at Butt Valley Dam.

Description of Operations: This measure does not affect operations. Implement normal operations at Caribou Intakes and Caribou PHs.

Detailed Description of Facilities Improvements and Design Criteria:

To be effective, the curtain must be designed such that the velocities in the open area under the curtain are relatively low, in the range of 0.10 - 0.25 fps. This objective is achieved with a Hypalon fabric curtain approximately 1,960 ft long by 42 ft deep (total area = 63,000 sq ft) extending about 980 ft offshore from the high shoreline. The curtain is “fixed,” meaning that as the reservoir level fluctuates the level of the lower lip of the curtain, which is set about 10 ft above the reservoir bottom, remains constant with respect to the reservoir bottom. In this way, the total open area under the curtain is maintained at the required 5,930 sq ft. Galvanized steel bin-type walls extend about 200 ft offshore from the shoreline and connect to the curtain endpoints.

List of Figures:

- General location map of Caribou Intake thermal curtain
- Plan view of Caribou Intake thermal curtain site layout
- Elevation views of Caribou Intake thermal curtain

Key Design or Construction Uncertainties Requiring Further Study:

- The Caribou Intake thermal curtain design is conceptual, particularly the curtain location and curtain depth. Further analysis is needed to develop details for the design and operation of the curtain, including physical prototype hydraulic testing and/or mathematical hydrodynamic modeling.

Discussion:

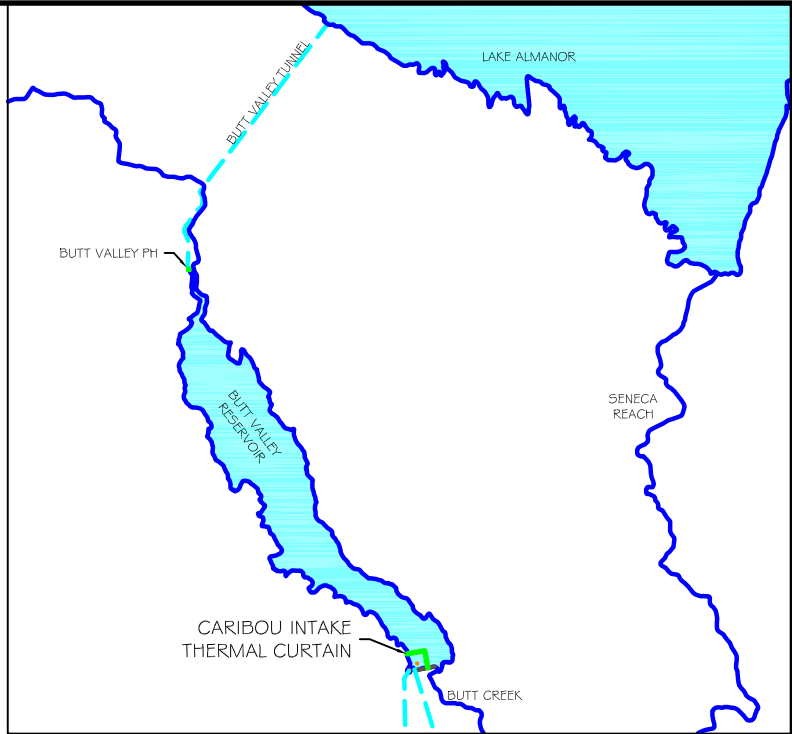
Butt Valley Reservoir has a storage capacity of 49,897 acre-feet. Water surface elevations fluctuate by about 10 to 15 feet from the maximum water surface elevation of 4,142 feet (USGS datum) on an annual basis. The reservoir serves as the afterbay to Butt Valley PH and the forebay for the Caribou No.1 and No. 2 PHs. Some additional flow enters Butt Valley Reservoir through Butt Creek and possibly through seepage. Water is delivered to the two Caribou powerhouses through two separate intake structures near Butt Valley Dam and there are no low-level outlets constructed at the dam. The Caribou No. 1 Intake is located at an invert elevation of 4,077 feet (USGS datum) in Butt Valley Reservoir and delivers up to 1,100 cfs to the Caribou #1 PH. The Caribou No. 2 Intake is located in a shallow cove area with an entrance elevation of 4,110 feet (USGS datum)

and normally delivers up to 1,460 cfs to the Caribou No. 2 PH. Both Caribou No. 1 and No. 2 PHs discharge to Belden Reservoir located in the NFFR approximately 10 river miles downstream of Canyon Dam Outlet. Caribou No. 2 PH is a preferred generating PH because it has higher turbine efficiency than Caribou No. 1 PH by about 15%.

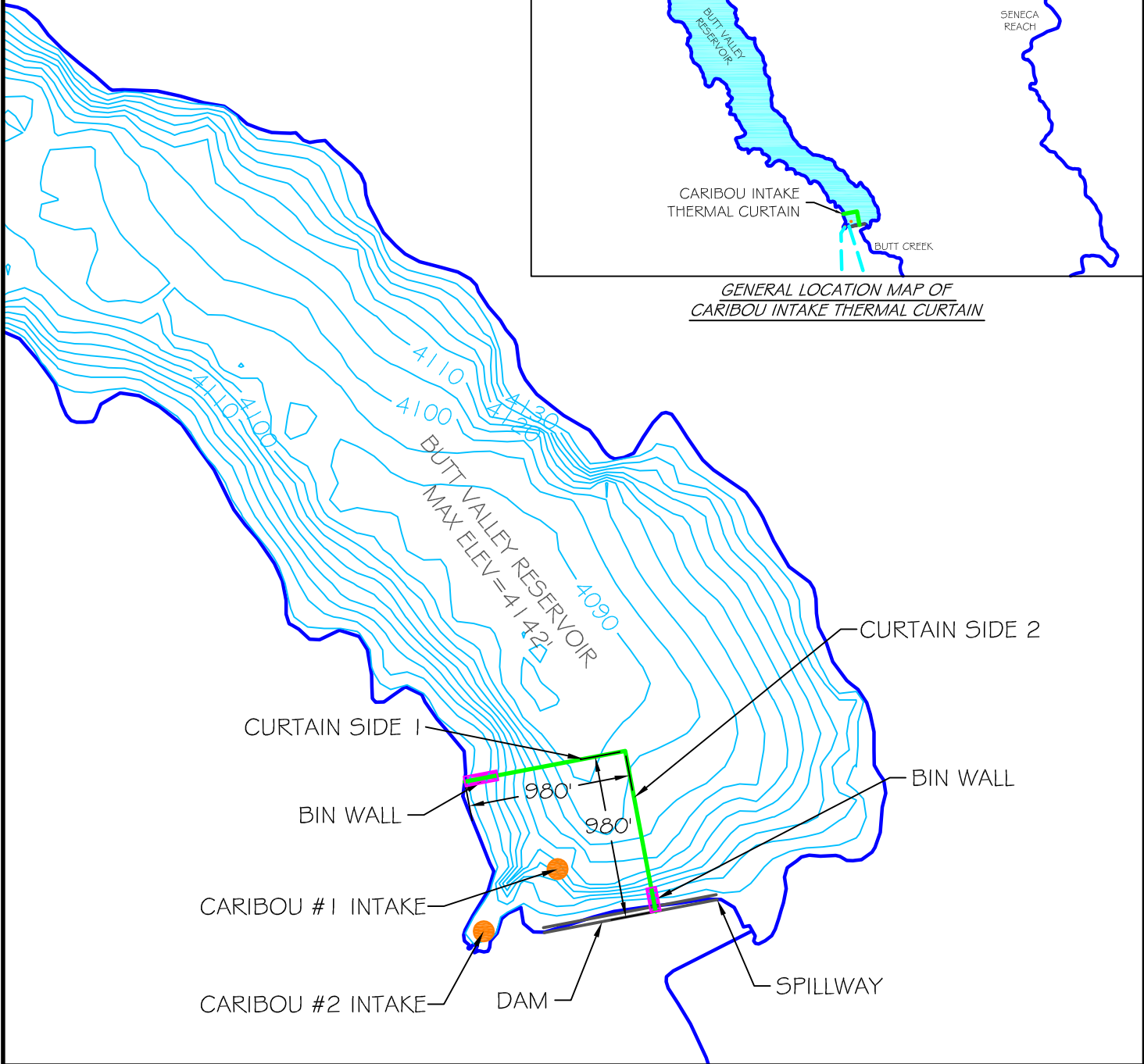
Historical water temperature measurements indicated that Caribou No. 1 Intake mainly draws cold hypolimnion water while Caribou No. 2 Intake mainly draws warm surface water. To cause Caribou No. 2 Intake to draw cold hypolimnion water, installing a thermal curtain is necessary. Bin-type walls would be constructed at the two ends of the curtain from the high water line to about 30 ft beyond the low water level to reduce localized damage to the curtain arising from water level fluctuations of the reservoir. When the water elevation is drawn down a significant amount of the curtain would be exposed making the curtain vulnerable to damage from vandalism, wind, and debris. At Whiskeytown the curtain tore at these locations, was vandalized, and was buried by sand preventing it from floating when the water rose. Similar to Black and Veatch's design for the Prattville Intake thermal curtain, a trolley system is proposed at the end of the bin walls. This system allows the top of the curtain to slide up and down as the water surface varies preventing stresses in the curtain. It prevents the curtain from being exposed and buried in the sand and discourages vandalism. This system also eliminates the periodic maintenance that may be necessary to free the curtain buried by sand and prevented from floating.

Cost Estimate of Caribou Intake Thermal Curtain

Item	Quantity	Unit	Unit Cost	Cost	Source
Basic Thermal Curtain System	1,960	LF	1,700	\$3,332,000	Unit cost derived from Prattville Intake thermal curtain evaluation.
Bin Walls	1	LS	1,356,000	\$1,356,000	Black & Veatch, 2004 index to 2007 by 7.6% increase
Scuba Diving	1	LS	689,000	\$689,000	Black & Veatch, 2004 index to 2007 by 7.6% increase
Total				\$5,377,000	

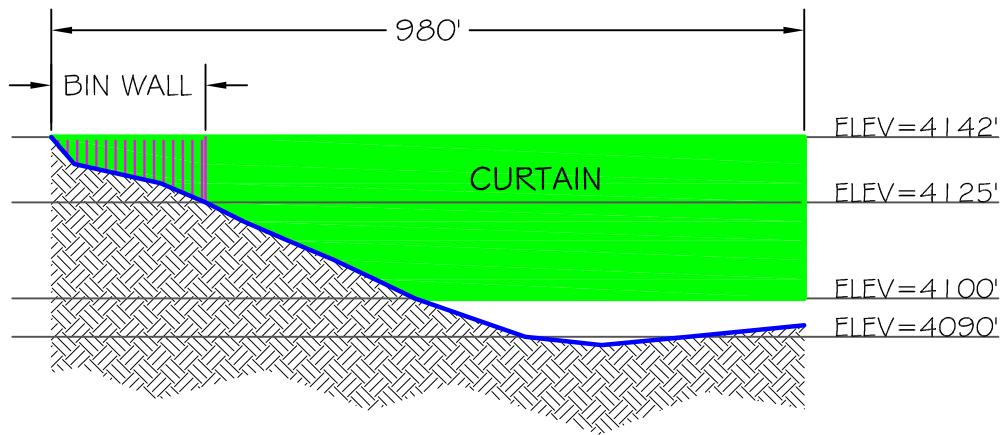


GENERAL LOCATION MAP OF
CARIBOU INTAKE THERMAL CURTAIN

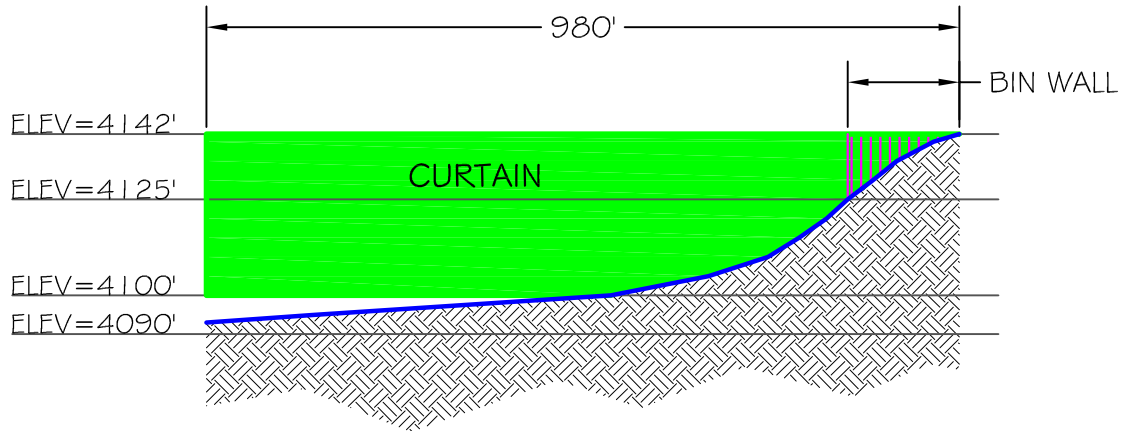


PLAN VIEW OF CARIBOU INTAKE
THERMAL CURTAIN SITE LAYOUT





SIDE 1



SIDE 2

ELEVATION VIEW OF CARIBOU INTAKE
THERMAL CURTAIN



Measure Name: Belden PH Intake Thermal Curtain

Applicable Alternative Category(s): 5; additional measure for Belden Reach

Description of Measure: Install a fixed Γ -shaped “upper curtain” at the Belden PH Intake. The purpose of the thermal curtain is to allow the Belden PH Intake to draw cool water from the lower strata of Belden Reservoir to Belden PH for the purpose of reducing water temperatures in the downstream Rock Creek, Cresta, and Poe reaches, while maintaining sufficient cold water release to the Belden Reach from the low-level outlet of Belden Dam. The Γ -shaped curtain does not affect flow to the spillway at Belden Dam.

Description of Operations: This measure does not affect operations. Implement normal operations at Belden PH Intake and Belden PH.

Detailed Description of Facilities Improvements and Design Criteria:

To be effective, the curtain must be designed such that the velocities in the open area under the curtain are relatively low, in the range of 0.10 - 0.25 fps. This objective is achieved with a Hypalon fabric curtain approximately 780 ft long by 55 ft deep (total area = 36,710 sq ft) extending about 400 ft offshore from the high shoreline. The curtain is “fixed,” meaning that as the reservoir level fluctuates the level of the lower lip of the curtain, which is set about 50 ft above the reservoir bottom, remains constant with respect to the reservoir bottom. In this way, the total open area under the curtain is maintained at the required 23,040 sq ft. Galvanized steel bin-type walls extend about 35-80 ft offshore from the shoreline and connect to the curtain endpoints.

List of Figures:

- General location map of Belden PH Intake thermal curtain
- Plan view of Belden PH Intake thermal curtain site layout
- Elevation views of Belden PH Intake thermal curtain

Key Design or Construction Uncertainties Requiring Further Study:

- The Belden PH Intake thermal curtain design is conceptual, particularly the curtain location and curtain depth. Further analysis is required to develop details for the design and operation of the curtain. In particular further analysis to evaluate the sustainability of routing cold water through the reservoir by balancing inflows relative to outflows will be required. Belden Reservoir outflows include (1) the instream flow released to the NFFR below Belden Dam, and (2) the power generation flow drawn through the Belden intake structure for delivery to Belden PH. The ability to sustain a thermally stratified condition created by the cold water plunging and routing through Belden Reservoir will be evaluated using modeling techniques.

Discussion:

Belden Reservoir has a maximum water surface elevation of 2,985 feet (USGS datum) and a theoretical usable storage capacity of 2,477 acre-feet. Under normal operations, the water surface elevation fluctuates between 2,960 and 2,973 feet, depending on power

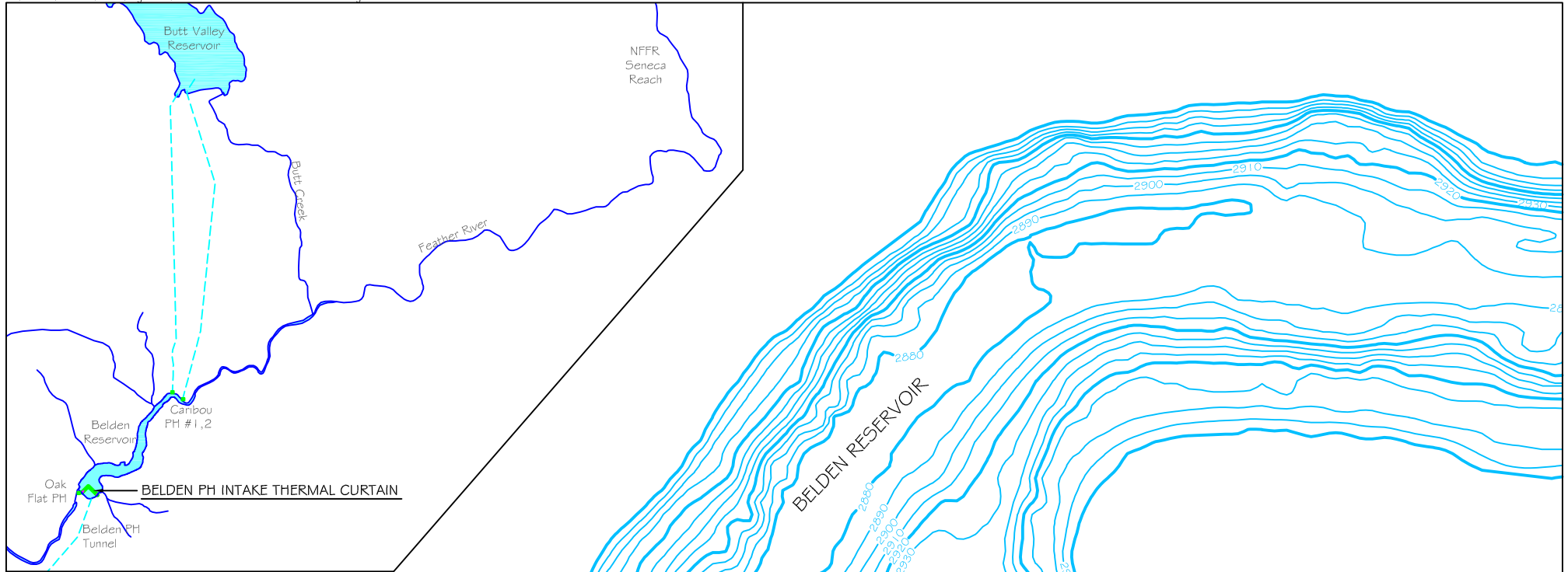
operations. The average hydraulic residence time in Belden Reservoir is estimated at approximately 0.5 to 1.0 days. The principal sources of inflow to this small reservoir are the Caribou No. 1 and No. 2 PHs. Additional inflow is received from the Seneca Reach of the NFFR. The Belden PH Intake structure is located near the downstream end of the reservoir with an invert elevation at 2,942 ft (USGS datum). The intake can release up to 2,610 cfs to Belden PH which is located on Yellow Creek, immediately upstream of the confluence of Yellow Creek with the NFFR. Instream flow releases from the Belden Reservoir to the NFFR immediately downstream of the Belden Dam were made from the dam's low-level outlet at el. 2,877 ft (USGS datum) to Oak Flat PH.

Historical water temperature measurements indicate that the low-level outlet draws cool bottom water of the reservoir and the Belden PH Intake draws warm surface water of the reservoir. That the Belden PH Intake draws warm surface water of the reservoir was clearly demonstrated in the 2006 special test (Stetson and PG&E 2007) that the Belden PH Intake did not access the cold water pool even though there was a strong reservoir stratification created during the test: Instead, it withdrew warm water from the surface of the reservoir. The Belden PH discharge is the primary source of water to the downstream Rock Creek, Cresta, and Poe Reaches. A measure that would cause the Belden PH Intake to draw from the deeper cold water pool would be an effective way to reduce water temperatures in the downstream reaches.

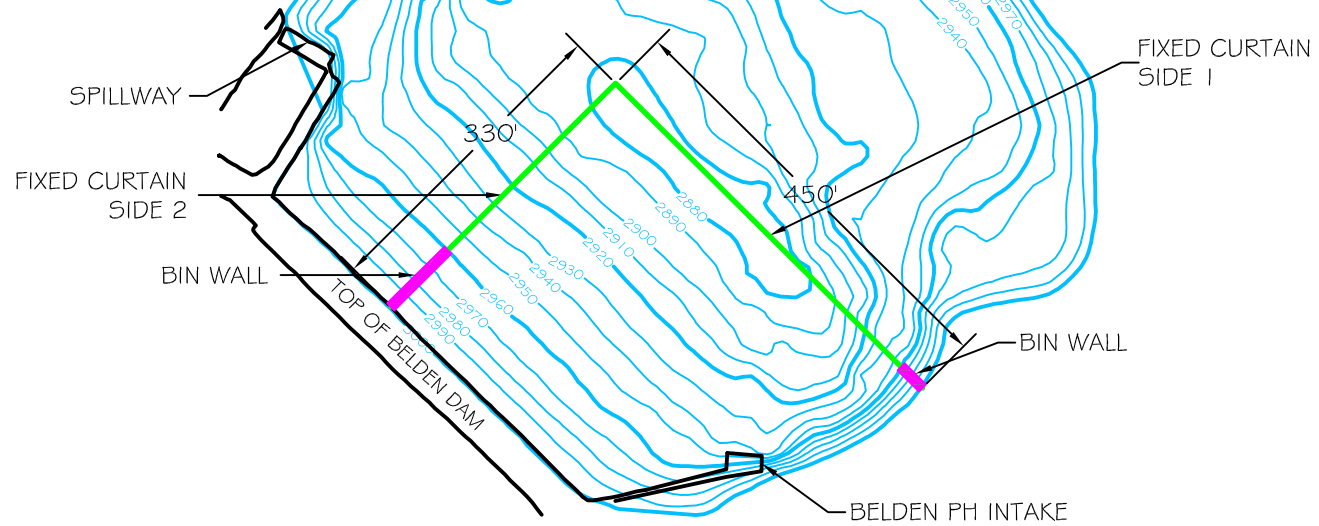
To reduce localized damage to the curtain arising from large water level fluctuations of the reservoir, bin-type walls would be constructed at the two ends of the curtain from the high water line to about 20 ft beyond the low water line. When the water elevation is drawn down a significant amount of the curtain would be exposed making the curtain vulnerable to damage from vandalism, wind, and debris. At Whiskeytown the curtain tore at these locations, was vandalized, and was buried by sand preventing it from floating when the water rose. Similar to Black and Veatch's design for the Prattville Intake thermal curtain, a trolley system is proposed at the end of the bin walls. This system allows the top of the curtain to slide up and down as the water surface varies preventing stresses in the curtain. It prevents the curtain from being exposed and buried in the sand and discourages vandalism. This system also eliminates the periodic maintenance that may be necessary to free the curtain buried by sand and prevented from floating.

Cost Estimate of Belden PH Intake Thermal Curtain

Item	Quantity	Unit	Unit Cost	Cost	Source
Basic Thermal Curtain System	780	LF	1,700	\$1,326,000	Unit cost derived from Prattville Intake thermal curtain evaluation.
Bin Walls	1	LS	1,356,000	\$1,356,000	Black & Veatch, 2004 index to 2007 by 7.6% increase
Scuba Diving	1	LS	689,000	\$689,000	Black & Veatch, 2004 index to 2007 by 7.6% increase
Total				\$3,371,000	

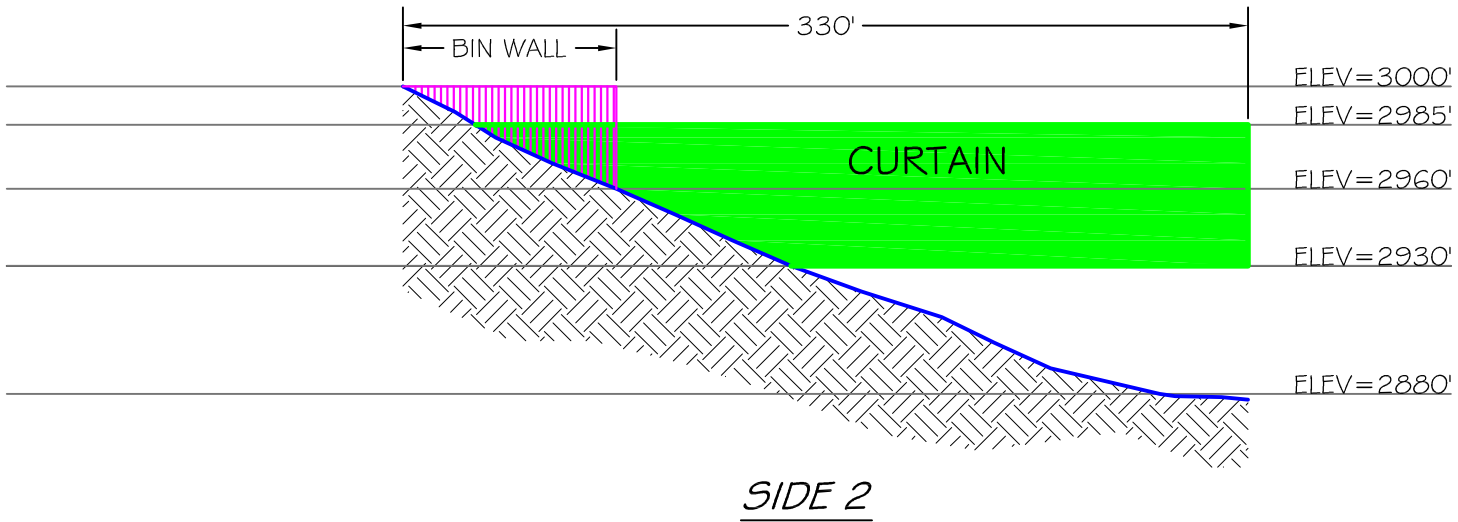
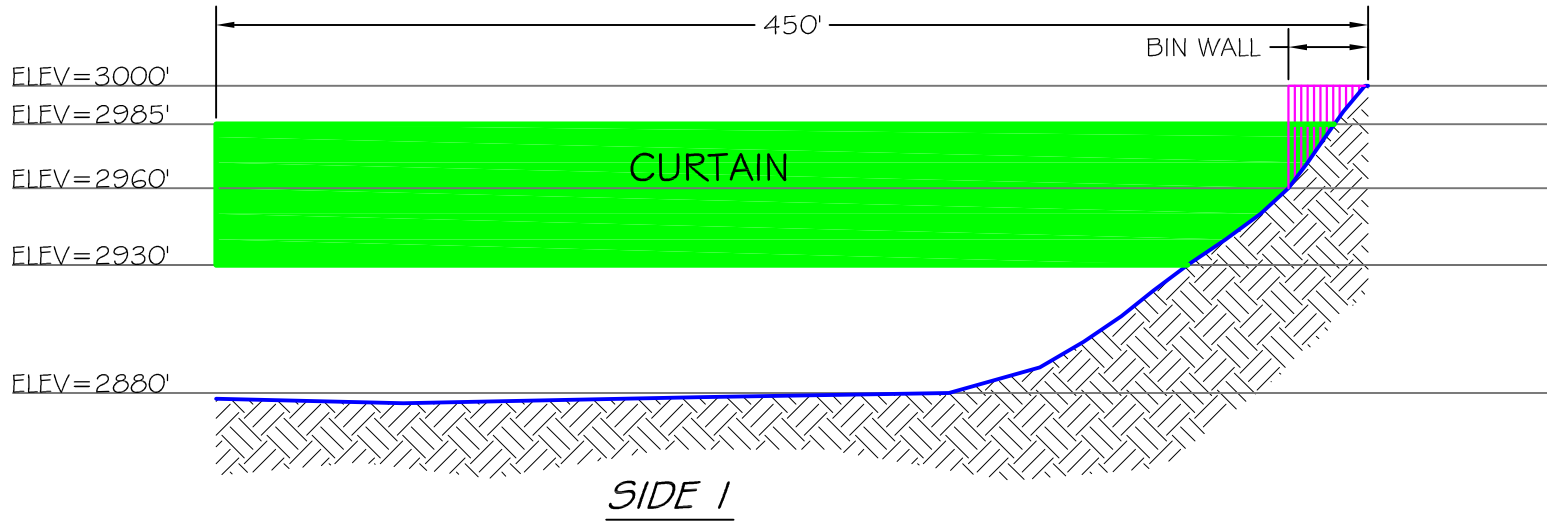


GENERAL LOCATION MAP OF BELDEN PH INTAKE THERMAL CURTAIN



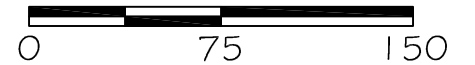
PLAN VIEW OF BELDEN PH INTAKE THERMAL CURTAIN





ELEVATION VIEW OF BELDEN PH
THERMAL CURTAIN

SCALE (FEET)



Measure Name: Modify/Repair Canyon Dam Low-Level Outlet and Increase Release

Applicable Alternative Category(s): 2c, 3, 4c, 5a, 5b, 5c, 6a

Description of Measure: Modify/repair the Canyon Dam low-level outlet and increase cool water release from the low-level outlet as needed during the summer. At present, the low-level outlet can safely release up to only 73 cfs. The purpose of this measure is to increase the cool water release from the hypolimnion of Lake Almanor to the NFFR.

Description of Operations: Depending upon the alternative, the release rate of the Canyon Dam low-level outlet ranges from about 90 cfs to 600 cfs. The maximum allowable discharge to avoid potential adverse impacts arising from velocity and scour to aquatic habitat along the Seneca Reach is estimated at about 700 cfs³. Increasing Canyon Dam release would require decreasing Prattville Intake release commensurately to avoid lake level fluctuation or changes from the operating rules agreed to in the Partial Settlement Agreement.

High release from the Canyon Dam low-level outlet would cause hydropower generation loss. The feasibility of hydropower generation to recover the foregone power by constructing a powerhouse below Canyon Dam will be investigated further in Level 3.

Detailed Description of Facilities Improvements and Design Criteria:

Modify and repair two (Gates #1 and #5) of the three low level outlets by connecting two pre-fabricated steel bulkheads with built-in slide gates to the existing outlets to enable controllable releases up to 600 cfs. Modifying and repairing Gate #1 only can release up to about 340 cfs.

List of Figures:

- Location map of Canyon Dam
- Flow Improvement Modifications/ Plan & Sections/ Canyon Dam Intake Tower

Key Design or Construction Uncertainties Requiring Further Study:

- There are concerns about vibrations during high discharges which require further study.

³ At 700 cfs, the river stage is approximately at bankfull in the lower half of the Seneca reach near the Seneca Resort and China Bar areas. Flows exceeding about 700 cfs result in over bank flows in this reach (PG&E 2002), which would, therefore, be avoided. Flows between 600 and 700 cfs begin to mobilize spawning gravel and flows greater than 700 cfs can result in significant movement of streambed materials in the Seneca reach (PG&E 2002). Since most trout spawning and egg incubation is completed by July (PG&E 2002), any minor movement of gravel at flows as high as 700 cfs would not disturb fish nests. Habitat area for adult trout increases with flow to near a maximum between 300 and 800 cfs, but it gradually decreases for rearing juvenile trout from a maximum habitat area at about 50 cfs to about 70% of the maximum at 700 cfs (PG&E 2002). However, juvenile trout rearing habitat provided at a flow of 700 cfs would result in about 80% of that provided by the FERC-recommended minimum stream flows during the same season (13,000 ft²/1000 ft vs. 16,000 ft²/1000 ft) (PG&E 2002). Although some variable decrease in juvenile rearing habitat area could occur during periods when river temperature management would be needed, it is not likely to limit trout production (Source: Keith. Marine, Fisheries Scientist, NSR, June 8, 2007). This estimate of the maximum allowable discharge will be re-examined in Level 3.

- The design used the normal maximum water surface elevation of Lake Almanor as the basis for providing up to 600 cfs flows when all low-level gates and valves are opened. Actual flows through each gate or valve needs to be determined using field data and shop testing prior to installation.
- The required number of gages and valves depend on the required release rate from the low-level outlet which will be studied further in Level 3.

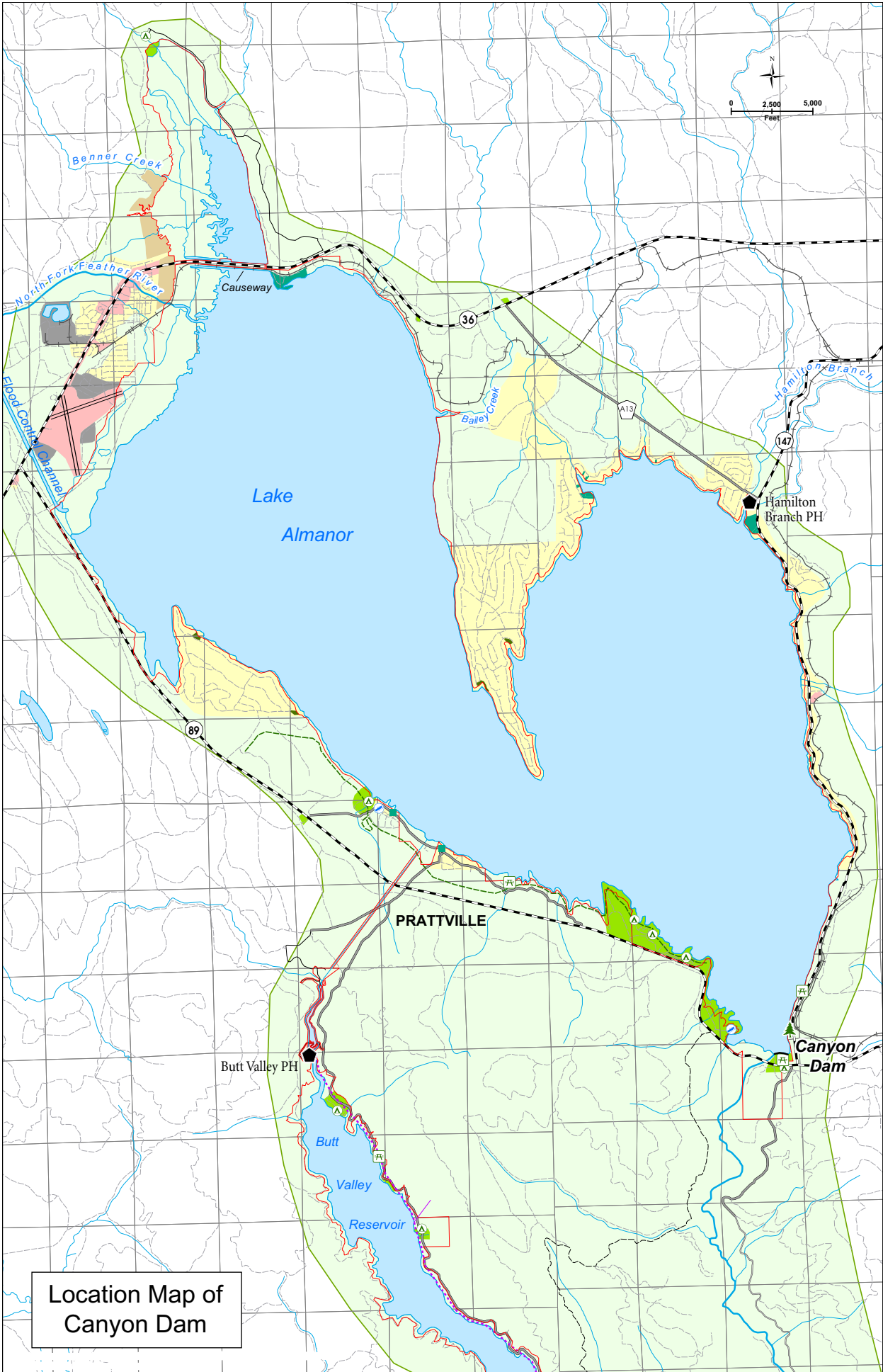
Discussion:

The Canyon Dam Intake Tower has three low level outlets gates – Gates #1, #3, #5 – all are set at elevation 4432 ft, about 72 ft below the maximum lake level elevation of 4504 ft USGS datum⁴. These three low level gates are damaged or are in poor condition due to corrosion and long-term hydrostatic loading on the gates and gate-stems. PG&E inspections revealed the bad gate-stems, gate connections, and bolts. In August-October 2005 did repair work on Gate #5 and rehabilitated the gate and gate-stem connection at a cost of about \$860,000. Gate #5 is the only low level gate that is currently operable, but its operation is limited and it can reliably and safely release up to only about 73 cfs.

The needed modification and repair work to Gates #1 and #5 is depicted in preliminary design drawings prepared by Black and Veatch. PG&E estimates the cost to complete the work at about \$10 million per gate, for a total cost for both gates of about \$20 million. This estimate is based in large part on actual costs incurred in the repair of Gate #5.

To comply with FERC requirements, PG&E is currently investigating the need for additional modifications and repairs to the overall Canyon Dam Outlet Tower and Tunnel Works to address concerns about vibrations during high discharges and outlet capacity limitations. It may be possible to incorporate the modification and repair work to Gates #1 and #5 described herein into this overall workplan.

⁴ There are two additional gates that are set even lower, Gates #2 and #4, at el. 4410. But these two gates are buried under about 20 ft of sediment and are considered unrepairable and permanently inoperable.



Location Map of Canyon Dam

Intentionally Not Shown:

**Figure of Flow Improvement Modifications/Plan and Sections/Canyon Dam Intake
Tower**

Measure Name: Convey Butt Valley PH Discharge through Butt Valley Reservoir by a Submerged (Dredged) Channel to an Endpoint near the Caribou Intakes

Applicable Alternative Category(s): 2c

Description of Measure: Dredge to enlarge the existing channel that is submerged along the bottom of Butt Valley Reservoir and extend it to an endpoint near the Caribou Intakes. The purpose of this measure is to reduce warming caused by mixing of cool Butt Valley PH discharge during its transport through Butt Valley Reservoir. The 2006 NFFR special test conducted by PG&E in Butt Valley Reservoir revealed the existence of a submerged channel along the bottom in the upper portion of the reservoir. During the special test, the cool discharge from Butt Valley PH was observed plunging to the reservoir bottom and moving mainly in the submerged channel along the bottom in the upper portion of the reservoir with minimal mixing with warm surface water of Butt Valley Reservoir. The submerged channel is shown in an aerial photo taken in 1997 when the reservoir was drawn down to enable work on the dam.

During the special test, some cool water was found to be flowing outside of the submerged channel, implying that the capacity of the channel was insufficient to convey the 500 cfs cool water discharge. In addition, the submerged channel was found to fade out and end about 6,600 ft downstream of the Butt Valley PH near Transect 5 as shown in attached figures. Downstream of this end point, the cool water was found to mix with warmer water in the reservoir which reduced the cool water inflow to the Caribou Intakes.

Description of Operations:

To draw cool water from the hypolimnion of Lake Almanor for transport to Butt Valley Reservoir, reduce Butt Valley PH discharges to about 500 cfs. This would necessitate commensurate reductions in the discharges for the Caribou PHs.

Detailed Description of Facilities Improvements and Design Criteria:

It is proposed that the existing bottom channel of Butt Valley Reservoir be extended along the lake bed by dredging to convey cold water releases from Butt Valley PH to the downstream section of the reservoir, near the Caribou Intakes. The cold water will flow in the dredged channel along the lake bed as a negatively-buoyant, density driven current.

During the 2006 NFFR special test when 500 cfs of cool water was discharged from Butt Valley PH the average velocity of the current observed flowing in the submerged channel was of 0.4 ft/s. To fully contain and convey the 500 cfs in the channel with minimal mixing, the dimensions of the channel need to be as given in the table below. Dredging is required to enlarge the existing channel and extend it a distance of approximately 16,800 ft to an endpoint near the Caribou Intakes. At this extended endpoint, the cool water could be drawn with minimal mixing into the Caribou #1 Intake.

Dimension	Value
Side slopes	3H:1V
Bottom width	60 ft
Top width	132 ft
Depth	12 ft ¹
Cross sectional area	1,152 ft

1) Based on the thickness of the cool water layer observed during the special test.

List of Figures:

- Butt Valley Reservoir Dredged Channel Alignment for Cold Water Deliver
- Historical Arial Photo Showing the Existing Channel in the Upper Portion of Butt Valley Reservoir

Key Design or Construction Uncertainties Requiring Further Study:

- The submerged tree trunks on the reservoir bed may make construction of the dredged channel difficult.
- The dredged conveyance channel at the bottom of Butt Valley Reservoir may slowly fill with sediment over time requiring future repeated dredging.

Discussion:

The required submerged channel dimensions and 16,800 ft extension to a new endpoint near the Caribou Intakes is estimated based on the best information available. The dimensions, extension distance and endpoint may be refined based on further analysis using physical prototype hydraulic modeling and/or mathematical hydrodynamic modeling. In particular, further analysis may reveal that the channel need extend only about 8,000 feet to an endpoint near the middle of the reservoir.

COST ESTIMATE FOR BUTT VALLEY RESERVOIR DIVERSION BY DREDGING A SUBMERGED CHANNEL					
ITEM	QUANTITY	UNIT	UNIT COST	COST (\$)	Source
Mobilization/Demobilization of Equipment					
Mobilization/demobilization	1	LS	250,000	250,000	Based on actual CPEN Lake O'Neil project, CA - cost estimate for hydraulic dredging. See Note 1
Site Establishment					
Site Establishment	1	LS	15,000	15,000	Nominal cost
Dredging					
Dredge channel using barge mounted clamshell and dump in fill site or stockpile on bank	774,400	CY	13.04	10,101,270	Means, 2007 adj to Redding CA
Fill and Grade Camp Site Extension					
Spreading of dredged material using 300HP dozer, 300' haul, no compaction	387,200	CY	3.76	1,456,270	Means, 2007 adj to Redding CA
Camp Site Rehabilitation					
Hydro or air seeding, turf mix, with mulch and fertilizer	697	SF x 1,000	43.48	30,300	Means, 2007 adj to Redding CA
Resurface gravel road, 12' wide and apx 1000' long	12,000	SF	1.93	23,160	Means, 2007 adj to Redding CA
TOTAL				\$11,876,000	

Notes:

Costs of geologic/geotechnical survey not included

Regional index = 108.7 for Redding

Mobilization of dredging equipment for CPEN Lake O'Neil project, CA quoted by Perry & Shaw Inc at \$175,500. Approx \$75,000 contingency included for remote location, road conditions etc.

No additional dewatering of dredged materials necessary if using a clamshell dredge and dumping onto transport barge.

Assume no rock to be excavated. Dredge to remove deposited sediment from remnant channel

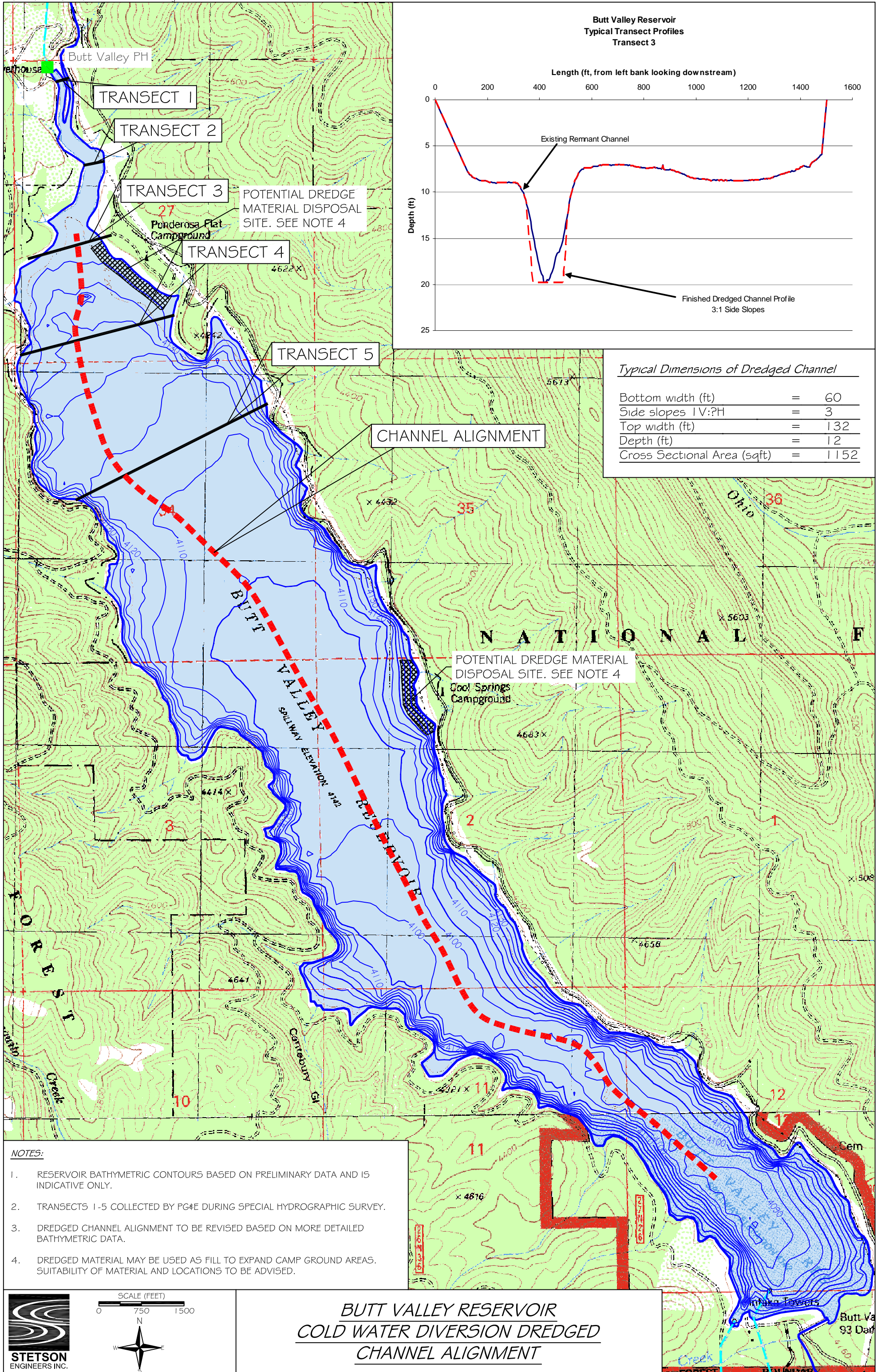
Assume dredged material is suitable for fill and land reclamation and no imported material required.

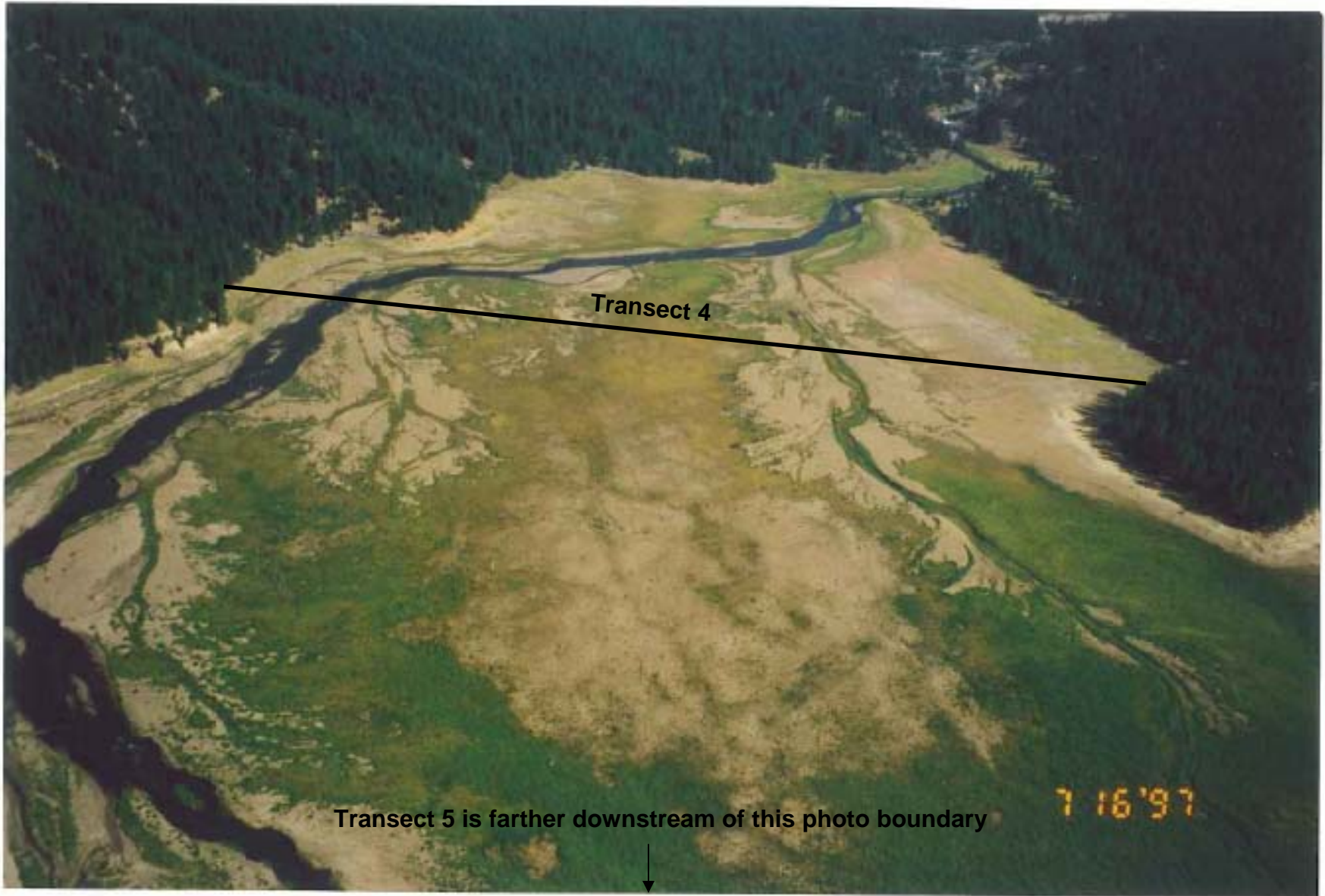
Assume 1/2 of dredged material can be placed on fill site directly from barge. Area to be rehabilitated calculated assuming 15' thick fill layer

Water quality controls (silt curtains, etc) are not included

Landscaping and construction of camp facilities not included

CPEN: Camp Pendleton, CA





Historical Aerial Photo showing the Existing Channel in the Upper Portion of Butt Valley Reservoir

Measure Name: Convey Butt Valley PH Discharge through Butt Valley Reservoir by Submerged Pipeline to an Endpoint near the Caribou Intakes

Applicable Alternative Category(s): 2a, 5c

Description of Measure: Construct an approximately five mile long submerged pipeline to convey Butt Valley PH discharge through Butt Valley Reservoir for submerged discharge near the Caribou Intakes. The purpose of this measure is to eliminate warming caused by mixing of cool Butt Valley PH discharge during its transport through Butt Valley Reservoir.

Description of Operations: This measure does not affect PH operations.

Detailed Description of Facilities Improvements and Design Criteria:

Discharge from Butt Valley PH is conveyed about 1,150 feet to a small regulating pond in three, side-by-side, 13' x 9.5' reinforced concrete box (RCB) conduits. Near the upstream end, about 100 cfs is released from one of the conduits to the existing discharge channel to maintain wetted conditions in the channel for aquatic habitat. From the regulating pond water is conveyed through seven, side-by-side, 72-inch HDPE pipes set and anchored on the reservoir bottom. The higher water level in the regulating pond (el. 4,170 ft in USGS datum) relative to the reservoir (normal maximum water level at 4,142 ft in USGS datum) forces the water through the pipes. The pipes extend about 5-miles to a submerged outlet near the Caribou Intakes. A fixed thermal curtain placed in front of the Caribou Intakes causes cool water discharged from the outlet to be drawn to the intakes.

List of Figures:

- Plan view: Butt Valley PH to Caribou Intakes
- Profile: Butt Valley PH to Caribou Intakes

Key Design or Construction Uncertainties Requiring Further Study:

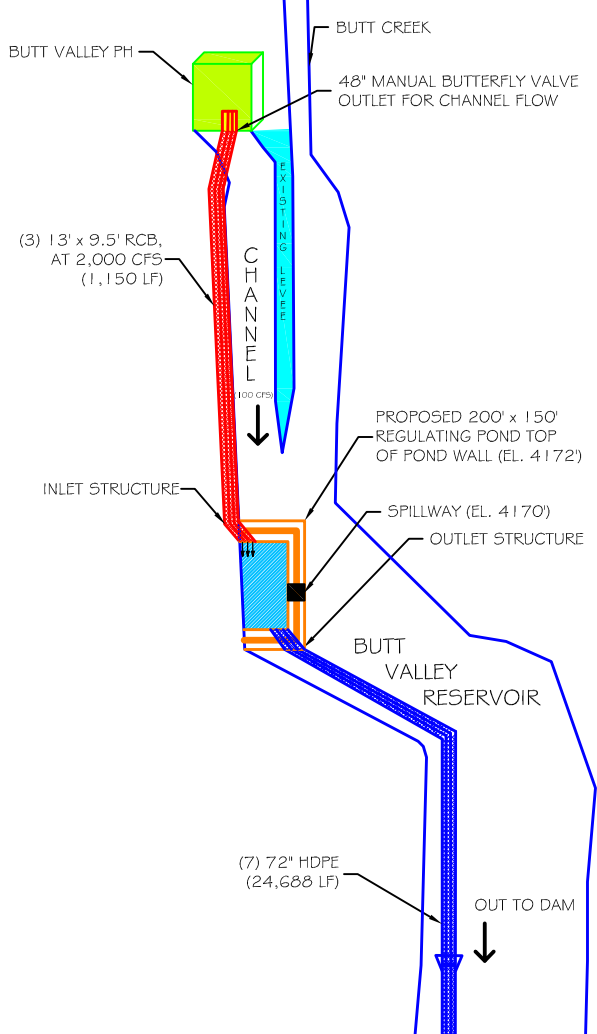
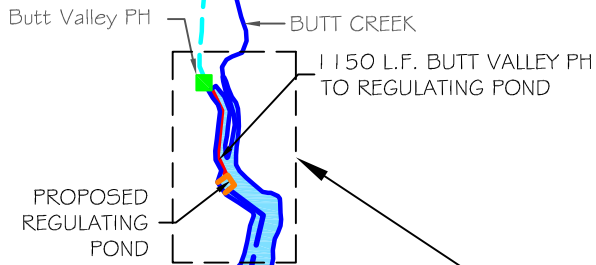
- Setting seven, 72-inch HDPE pipes along the bottom of Butt Valley Reservoir will be difficult and costly. Design and installation of an anchoring system adequate to withstand the potential forces on the pipe arising from flow momentum and land shifting requires further study.
- Connecting three, side-by-side, 13' x 9.5' reinforced concrete boxes to the turbine discharge pipes of Butt Valley PH requires further study.

Discussion:

The location of the pipeline endpoint near the Caribou Intakes is estimated based on the best information available, and it may be refined based on further analysis using physical prototype hydraulic modeling and/or mathematical hydrodynamic modeling. In particular, further analysis may reveal that the pipeline need extend only about 8,000 feet to an endpoint near the middle of the reservoir.

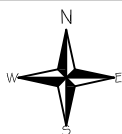
COST ESTIMATE FOR BUTT VALLEY PH TO CARIBOU INTAKES 2,000 CFS				
ITEM	QUANTITY	UNIT	UNIT COST	COST
Bypass Conduit from Butt Valley PH to Proposed Detention Basin				
Triple, 13' x 9.5' Reinforced Concrete Box	1150	LF	2,115	2,432,250
Tie in Structure at Powerhouse	1	LS	15,000	\$15,000
48-inch hydraulic operated butterfly valve for in channel low flow	1	LS	47,000	\$47,000
Excavation, truck mounted, 6-10' deep, 1 CY excavator, Hydraulic Jack hammer	9583	CY	12	\$114,996
Backfill, 6" layers, roller compaction operator walking	23000	CY	44	\$1,006,940
Compaction, walk behind vibrating plate, 18" wide, 6" lifts, 4 passes	23000	CY	3	\$69,690
Grouted Riprap Slope Protection, 3/8 to 1/4 CY Pieces, 18" Thick	7283	SY	120	\$877,165
1/2 CY bucket wheel mounted front end loader, min haul	32583	CY	16	\$517,744
Hauling, 20 mile round trip, 0.4 loads/ hr (Added 15% for Expansion)	15430	CY	27	\$410,438
Sediment and Erosion Control (Silt Fence)	1150	LF	5	\$5,819
		Sub total		\$5,497,000
Detention Basin				
Compaction, walk behind vibrating plate, 18" wide, 6" lifts, 4 passes	46602	CY	3	\$141,204
Backfill, 6" layers, roller compaction operator walking	46602	CY	44	\$2,040,236
Concrete bottom for detention basin	550	CY	1,800	\$990,000
1/2 CY bucket wheel mounted front end loader, min haul	53592	CY	16	\$851,577
Hauling, 20 mile round trip, 0.4 loads/ hr (Add 15% for Expansion)	53592	CY	27	\$1,425,547
Outlet Structure	1	LS	50,000	\$50,000
Inlet Structure	1	LS	100,000	\$100,000
Hydroseeding	3600	SY	1	\$3,600
Sediment and Erosion Control (Silt Fence)	500	LF	5	\$2,530
		Sub total		\$5,605,000
(7) 72" HDPE from Proposed Detention Basin to Plunging				
72-inch HDPE (Length Mult by 7)	172816	LF	425	\$73,446,800
HDPE Pipe Placement, concrete weight collars / "Float Flood" method, Mechanical Crane, barge mounted	1	LS	4,400,000	\$4,400,000
Underwater pipe laying preparation of reservoir bottom	1	LS	9,077,000	\$9,077,000
Diffuser Outlet Structure	1	LS	50,000	\$50,000
Attach 72" HDPE to diffuser structure and install pad / rock cover	1	LS	150,000	\$150,000
Upper Thermal Curtain around both	1	LS	3,101,500	\$3,101,500

Caribou Intakes				
		Sub total		\$90,225,000
Mobilization				
Dozer, above 150 HP (3)	1	LS	3,600	\$3,600
Excavator, 1-1.5 CY Diesel Hyd. (2)	1	LS	9,600	\$9,600
Loader (2)	1	LS	2,400	\$2,400
Dump truck, 26 tons (10)	1	LS	6,000	\$6,000
25 ton truck mounted hydraulic crane (2)	1	LS	2,000	\$2,000
Crawler Type Drill, 4" (1)	1	LS	700	\$700
Grout pumper (1)	1	LS	600	\$600
Water truck, 6000 gal (1)	1	LS	600	\$600
Wash & Screen (1)	1	LS	7,200	\$7,200
Mechanical Dredger / Crane, barge mounted and all loading equipment	1	LS	200,000	\$200,000
		Sub total Mob / Demob		\$233,000
				\$101,560,000



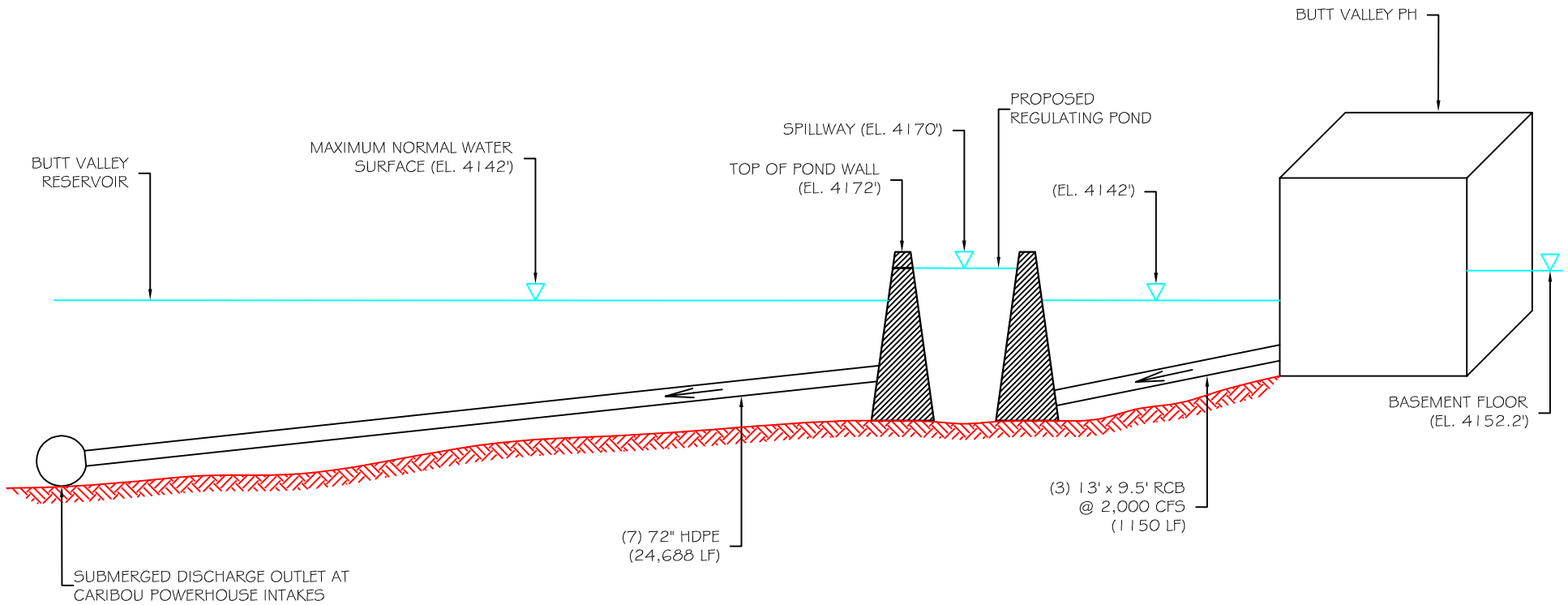
(7) 72" HDPE PIPE (24688 LF)

COOL SPRINGS CAMPGROUND



***BUTT VALLEY RESERVOIR
TO CARIBOU INTAKES PLUNGING***





BUTT VALLEY POWERHOUSE TO CARIBOU INTAKES

Measure Name: Divert Cool Seneca Reach Flows into a Submerged Pipeline to Discharge at an Appropriate Plunging Point in Belden Reservoir

Applicable Alternative Category(s): 5, 6; additional measure for Belden Reach

Description of Measure: Construct an approximately 1,900 ft long pipeline to convey cool Seneca Reach flows directly to a plunging location in Belden Reservoir, bypassing discharges from Caribou PHs No. 1 and 2. The purpose of this measure is to avoid mixing cool Seneca flows with warmer discharges from the Caribou PHs during operational hours and minimize mixing with warmer ambient waters near the surface of Belden Reservoir. Field observations in Belden Reservoir during the 2006 NFFR special test and preliminary reservoir hydrodynamic modeling by Stetson identified a plunging location downstream of which further mixing during transport along the bottom of the reservoir is minimal.

Description of Operations: This measure has no affect on PH operations. Operate the diversion system to convey about 250 cfs through the pipeline and spill the remaining flow over the dam. The diversion rate is supplied by the increased release measure from Canyon Dam low-level outlet. The flow accretion along the Seneca Reach, including inflows from lower Butt Creek, would maintain flows for aquatic habitat in the stream over the short distance between the diversion dam and the Caribou No. 1 discharge.

Detailed Description of Facilities Improvements and Design Criteria:

Construct a 7-foot high inflatable/deflatable rubber diversion dam at the lower end of Seneca Reach just upstream of Caribou PH No. 1. Except during summer, the rubber dam would remain in the deflated position. Construct an approximately 1,900 ft long pipeline to convey cool Seneca Reach flows captured behind the dam to a plunging location in Belden Reservoir.

The pipeline starts at the diversion dam and extends about 1,900 ft to a submerged diffuser at the bottom of Belden Reservoir. The first segment of the pipeline is about 400 feet long and consists of 72-inch reinforced concrete pipe (RCP) trenched into the river bank and covered with riprap. The second segment is about 180 feet long and consists of 72-inch Black Steel Pipe (BSP) which is connected to the face of Caribou PH #1, delivering flows to the northwest bank of the NFFR just upstream of Caribou PH #2. The third segment is about 360 ft long and consists of 72-inch RCP which is trenched along the toe of the north bank of the NFFR and protected with riprap. The fourth segment is about 400 feet and consists of 72-inch RCP which is buried along the shoulder of Caribou Road. The fifth and last segment is about 580 feet long and consists of 72-inch HPDE pipe that enters Belden Reservoir and is set on and anchored to the bottom of the reservoir for the remaining 580 feet. A submerged diffuser outlet is placed at the end of the pipeline to distribute the discharge in a larger cross sectional area for the purpose of reducing discharge velocity, turbulence, and mixing potential.

List of Figures:

- Plan view: NFFR / Lower Seneca Reach to Belden Reservoir Plunging.
- Profile: NFFR / Lower Seneca Reach to Belden Reservoir Plunging Outlet.

Key Design or Construction Uncertainties Requiring Further Study:

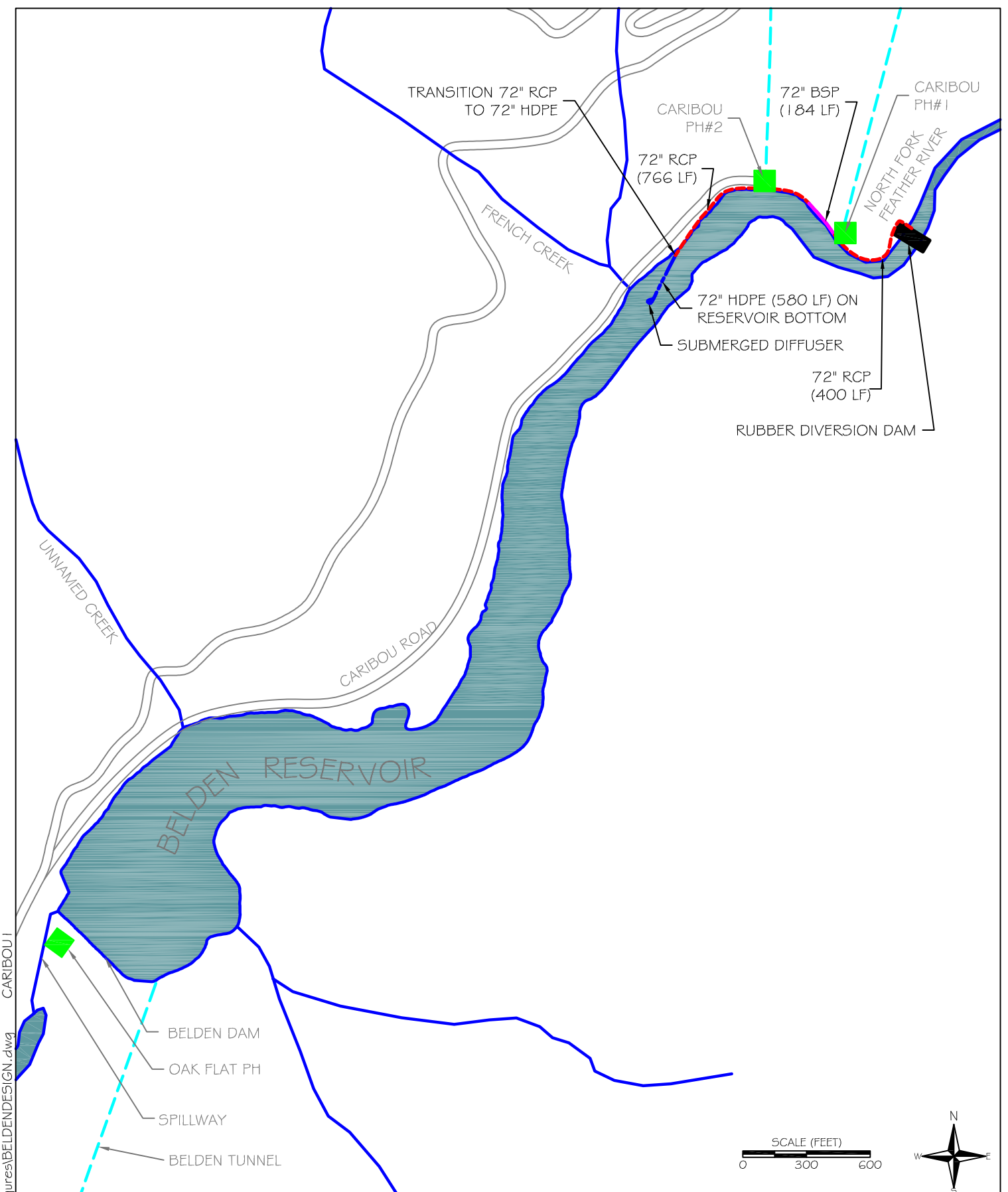
- Setting a 72-inch HDPE along the bottom of Belden Reservoir will be difficult and costly. Design and installation of an anchoring system adequate to withstand the potential forces on the pipe arising from flow momentum and land shifting requires further study.
- Placing and connecting a 72-inch reinforced concrete or black steel pipe to the faces of both powerhouses will require blasting and difficult construction, which could be hazardous due to unstable slopes and recent landslides.
- Pipeline construction beside Caribou Road will require blasting, jack hammering work due to the existing conditions being steep rock cliffs near the powerhouses, which could be hazardous due to unstable slopes and recent landslides.

Discussion:

The design and cost estimate for this measure is based on a flow rate of 250 cfs. The flow rate may be refined based on further analysis using mathematical hydrodynamic modeling which could affect the design.

COST ESTIMATE FOR BYPASSING COOL SENECA REACH FLOWS TO 250 CFS FOR PLUNGING				
ITEM	QUANTITY	UNIT	UNIT COST	COST
N FORK FEATHER RIVER RUBBER DAM AND INTAKE AT CARIBOU PHS				
7' high and 39' wide inflatable rubber dam including: mobilization, site prep, foundation, turnout structure and all necessary materials and construction.	1	LS	\$1,940,000	\$1,940,000
		Sub Total NF Feather River Dam		\$1,940,000
60" RCP from Rubber Dam to Caribou PH #1				
60-inch Reinforced Concrete Pipe, Class 3	400	LF	279	\$111,600
Grouted Riprap Slope Protection, 3/8 to 1/4 CY Pieces, 18" Thick	800	SY	120	\$96,352
Excavator, Clamshell, 1/2 CY, wet plus addit. Equip	1363	CY	26	\$34,934
Backfill, 6" layers, roller compaction operator walking	237	CY	44	\$10,376
Compaction, walk behind vibrating plate, 18" wide, 6" lifts, 4 passes	766	CY	3	\$2,321
Pipe bedding, crushed rock, 1/2" to 3/4"	529	CY	48	\$25,540
1/2 CY bucket wheel mounted front end loader, min haul	1090	CY	16	\$17,320
Hauling, 20 mile round trip, 0.4 loads/ hr (Add 15% for Expansion)	1090	CY	27	\$28,994
Sediment and Erosion Control (Silt Fence)	400	LF	5	\$2,024
		Sub total		\$329,000
60" Black Steel Pipe along Concrete Face of Caribou PH #1				
60" black steel pipe	184	LF	572	\$105,248
Drill concrete anchor bolts	184	LF	29	\$5,268
Install concrete anchor bolts	184	LF	25	\$4,659
Drill & Blast restricted areas	109	CY	214	\$23,326
1/2 CY bucket wheel mounted front end loader, min haul	125	CY	16	\$1,986
Hauling, 20 mile round trip, 0.4 loads/ hr (Add 15% for Expansion)	125	CY	27	\$3,325
Anchor rings	4	EACH	800	\$3,200
Precast Storm Drain Manhole, 6' I.D., 8' Deep	2	EACH	4,300	\$8,600
		Sub total		\$156,000
60" RCP from Concrete Face of Caribou PH #1 to N Fork Feather River / Toe of Caribou Road				
60-inch Reinforced Concrete Pipe, Class 3	366	LF	279	\$102,114
Compaction, walk behind vibrating plate, 18" wide, 6" lifts, 4 passes	682	CY	3	\$2,066
Backfill, 6" layers, roller compaction operator walking	198	CY	44	\$8,668
Pipe bedding, crushed rock, 1/2" to 3/4"	484	CY	48	\$23,368
Remove (load) small boulders (under 1/2 CY)	347	CY	17	\$6,062
Replace (load) small boulders (under 1/2 CY)	347	CY	17	\$6,062
Excavator, Clamshell, 1/2 CY, wet plus addit. Equip	597	CY	26	\$15,301
Drill & Blast in restricted areas	596	CY	214	\$127,544
1/2 CY bucket wheel mounted front end loader, min haul	998	CY	16	\$15,858
Hauling, 20 mile round trip, 0.4 loads/ hr (Add 15% for Expansion)	998	CY	27	\$26,547
Precast Storm Drain Manhole, 6' I.D., 8' Deep	1	EACH	4,300	\$4,300
Grouted Riprap Slope Protection, 3/8 to 1/4 CY Pieces, 18" Thick	407	SY	120	\$49,019
Sediment and Erosion Control (Silt Fence)	366	LF	5	\$1,852

		Sub total		\$389,000
60" RCP from Toe of Caribou Road to 400 feet Downstream				
60-inch Reinforced Concrete Pipe, Class 3	400	LF	279	\$111,600
Cofferdam, 15-22' Deep, 2 lines of braces, 10" H max	8000	SF	39	\$312,000
Compaction, walk behind vibrating plate, 18" wide, 6" lifts, 4 passes	938	CY	3	\$2,842
Backfill, 6" layers, roller compaction operator walking	409	CY	44	\$17,906
Pipe bedding, crushed rock, 1/2" to 3/4"	529	CY	48	\$25,540
Excavator, Clamshell, 1/2 CY, wet plus addit. Equip	771	CY	26	\$19,761
Drill & Blast in restricted areas	770	CY	214	\$164,780
1/2 CY bucket wheel mounted front end loader, min haul	1090	CY	16	\$17,320
Hauling, 20 mile round trip, 0.4 loads/ hr (Add 15% for Expansion)	1090	CY	27	\$28,994
Precast Storm Drain Manhole, 6' I.D., 8' Deep	1	EACH	4,300	\$4,300
Grouted Riprap Slope Protection, 3/8 to 1/4 CY Pieces, 18" Thick	569	SY	120	\$68,530
Sediment and Erosion Control (Silt Fence)	400	LF	5	\$2,024
Traffic Control	1	LS	10,000	\$10,000
		Sub total		\$786,000
60" HDPE from Toe of Caribou Road to underwater tie in at dam				
60-inch HDPE	4521	LF	354	\$1,600,434
HDPE Pipe Placement, concrete weight collars / "Float Flood" method, Mechanical Crane, barge mounted	1	LS	961,000	\$961,000
Underwater pipe laying preparation of reservoir bottom	1	LS	\$2,925,000	\$2,925,000
Attach to existing plugged inlet structure	1	LS	20,000	\$20,000
60-inch hydraulic operated butterfly valve	1	LS	60,000	\$60,000
48-inch hydraulic operated butterfly valve	1	LS	47,000	\$47,000
Attach hydraulic valve controls to existing sluice gate controls	1	LS	40,000	\$40,000
		Sub total		\$5,653,000
Mobilization				
Dozer, above 150 HP (3)	1	LS	3,600	\$3,600
Excavator, 1-1.5 CY Diesel Hyd. (2)	1	LS	9,600	\$9,600
Loader (2)	1	LS	2,400	\$2,400
Dump truck, 26 tons (10)	1	LS	6,000	\$6,000
25 ton truck mounted hydraulic crane (2)	1	LS	2,000	\$2,000
Crawler Type Drill, 4" (1)	1	LS	700	\$700
Grout pumper (1)	1	LS	600	\$600
Water truck, 6000 gal (1)	1	LS	600	\$600
Wash & Screen (1)	1	LS	7,200	\$7,200
Mechanical Dredger / Crane, barge mounted and all loading equipment	1	LS	200,000	\$200,000
		Sub total Mob / Demob		\$233,000
			TOTAL	\$9,486,000

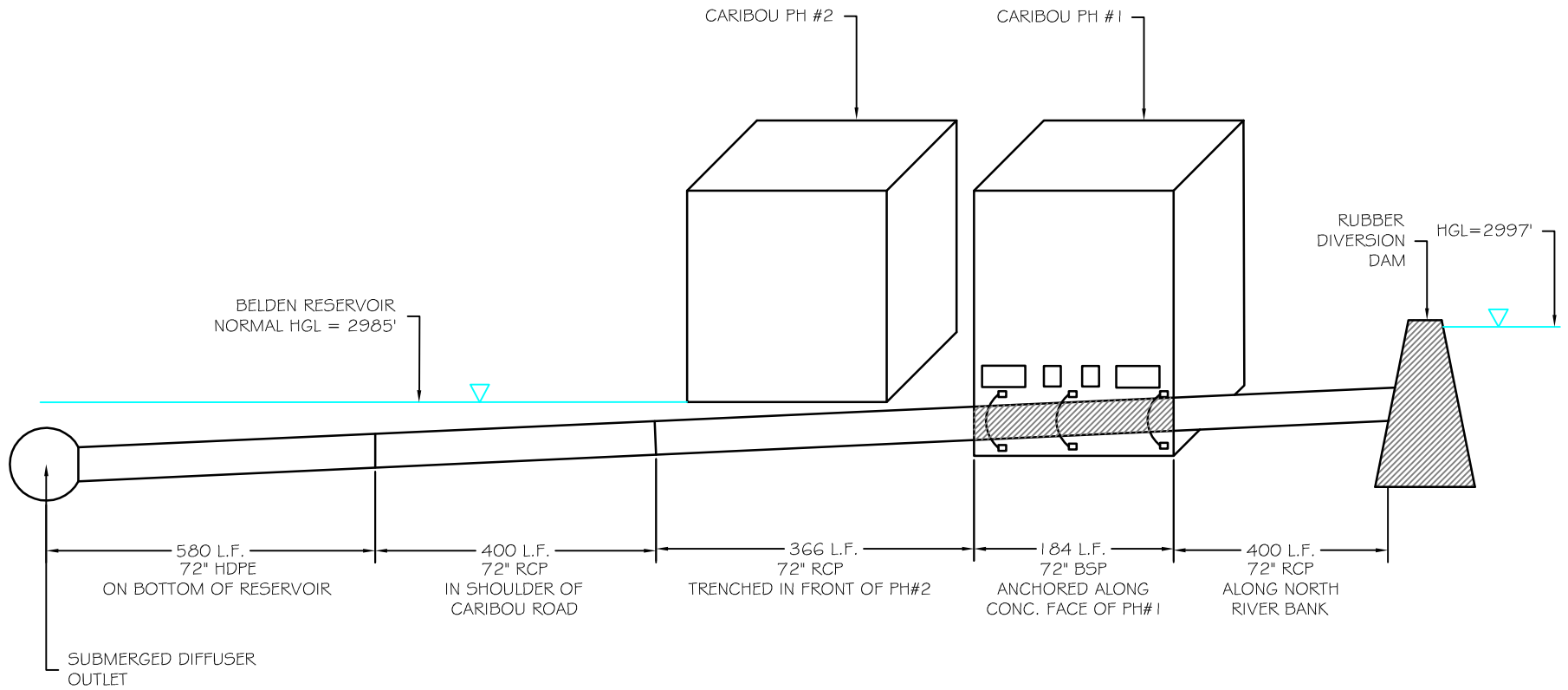


NFFR / LOWER SENECA REACH TO BELDEN
RESERVOIR PLUNGING



F:\Data\2125\CAD\Figures\BELDENDESIGN.dwg CARIBOU 1

NFFR / LOWER SENECA REACH TO BELDEN RESERVOIR PLUNGING OUTLET



Measure Name: Divert Cool Seneca Reach Flows and Convey by Pipeline to Discharge below Belden Dam

Applicable Alternative Category(s): 6a; additional measure for Belden Reach

Description of Measure: Construct an approximately 1.1 mile long pipeline to convey cool Seneca Reach flows to below Belden Dam, bypassing Belden Reservoir. The purpose of this measure is to avoid mixing cool Seneca flows with warmer discharges from the Caribou PHs during operational hours and minimize mixing with warmer ambient waters near the surface of Belden Reservoir.

Description of Operations: This measure has no affect on PH operations. Operate the diversion system to convey about 250 cfs through the pipeline and spill the remaining flow over the dam. The diversion rate is supplied by the increased release measure from Canyon Dam low-level outlet. The flow accretion along the Seneca Reach, including inflows from lower Butt Creek, would maintain flows for aquatic habitat in the short reach to the Caribou No. 1 discharge.

Detailed Description of Facilities Improvements and Design Criteria:

Construct a 7-foot high inflatable/deflatable rubber diversion dam at the lower end of Seneca Reach just upstream of Caribou PH No. 1. Except during summer, the rubber dam would remain in the deflated position. Construct an approximately 1.1 mile long pipeline to convey cool Seneca Reach flows captured behind the dam to connect to the existing Oak Flat PH outlet structure for discharge below Belden Dam.

The pipeline starts at the diversion dam and extends about 1.1 mile to a submerged diffuser at the bottom of Belden Reservoir. The first segment of the pipeline is about 400 feet long and consists of 60-inch reinforced concrete pipe (RCP) buried into the river bank and covered with riprap. The second segment is about 180 feet long and consists of 60-inch Black Steel Pipe (BSP) which is connected to the concrete face of Caribou PH #1, delivering flows to the northwest bank of the NFFR just upstream of Caribou PH #2. The third segment is about 360 ft long and consists of 60-inch RCP which is buried along the toe of the north bank of the NFFR and protected with riprap. The fourth segment is about 400 feet and consists of 60-inch RCP which is buried along the shoulder of Caribou Road.

The fifth and last segment is about 4,520 feet long and consists of 60-inch HPDE pipe that enters Belden Reservoir and is set on and anchored to the bottom of the reservoir. The end of the pipe connects to the existing outlet structure which conveys the flow through a 150-inch conduit to the Oak Flat PH. Because the capacity of the Oak Flat PH turbine is 150 cfs, a 100 cfs outlet from the 150-inch conduit is needed to discharge the flow in excess of the turbine capacity to the Belden Reach. Alternatively, PG&E may choose to increase the capacity of the turbine by 100 cfs.

List of Figures:

- Plan view: Lower Seneca Reach Bypass to Belden Dam Outlet
- Profile: Lower Seneca Reach Bypass

Key Design or Construction Uncertainties Requiring Further Study:

- Setting a 60-inch HDPE along the bottom of Belden Reservoir will be difficult and costly. Design and installation of an anchoring system adequate to withstand the potential forces on the pipe arising from flow momentum and land shifting requires further study.
- Attaching the end of the 60-inch HDPE pipe to the existing submerged intake and 150-inch outlet pipe will be difficult and costly due to construction underwater.
- Placing and connecting a 60-inch reinforced concrete or black steel pipe to the faces of both powerhouses will require blasting and difficult construction, which could be hazardous due to unstable slopes and recent landslides.
- Pipeline construction beside Caribou Road will require blasting, jack hammering work due to the existing conditions being steep rock cliffs near the powerhouses, which could be hazardous due to unstable slopes and recent landslides.

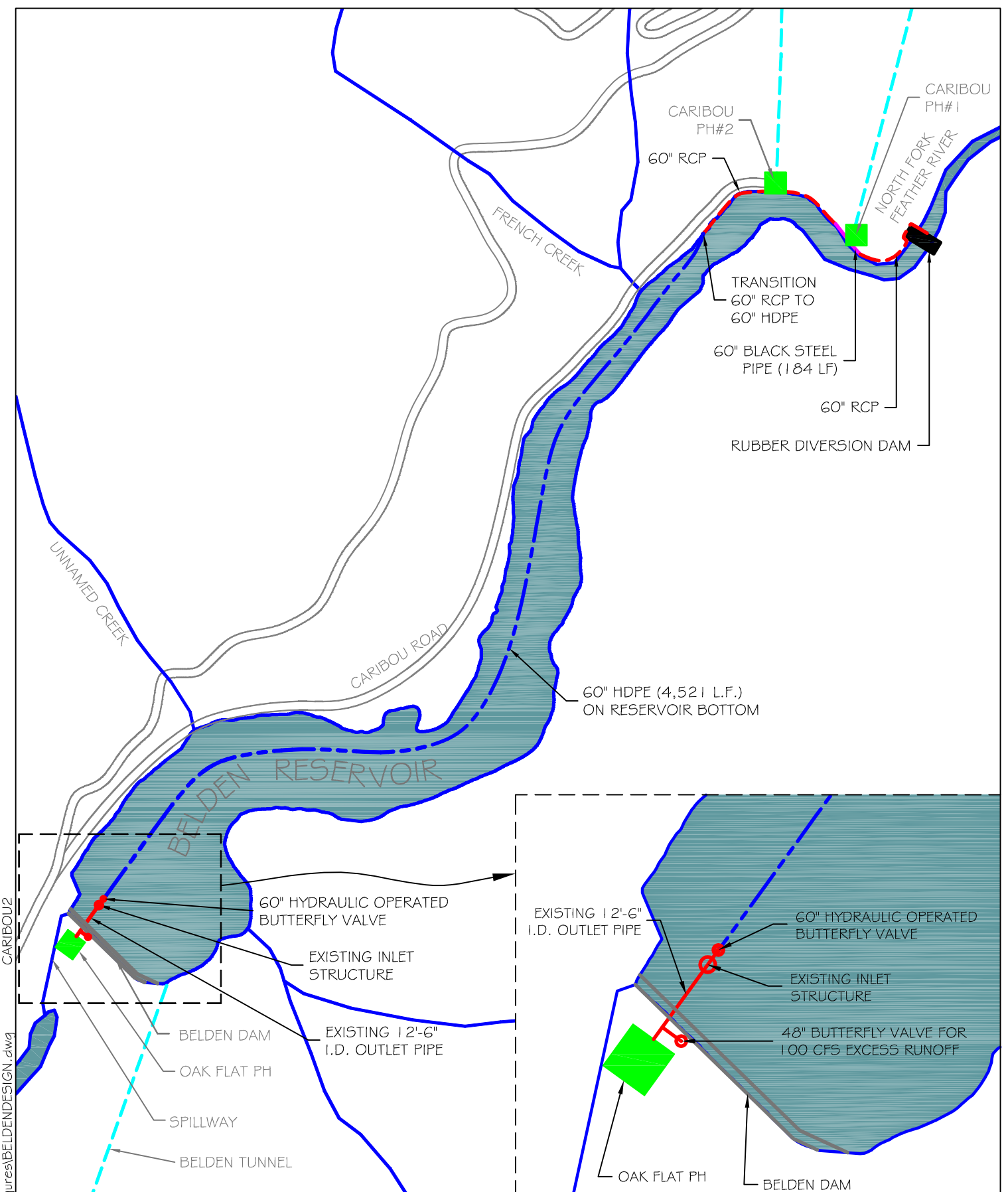
Discussion:

The 60-inch HDPE pipe was not placed along Caribou Road because the elevation gained near the dam would not allow the system to have gravity flow at the design flow rate of 250 cfs.

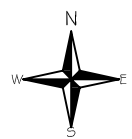
COST ESTIMATE FOR BYPASSING COOL SENECA REACH FLOWS TO 250 CFS TO BELOW BELDEN DAM				
ITEM	QUANTITY	UNIT	UNIT COST	COST
N FORK FEATHER RIVER RUBBER DAM AND INTAKE AT CARIBOU PHS				
7' high and 39' wide inflatable rubber dam including: mobilization, site prep, foundation, turnout structure and all necessary materials and construction.	1	LS	\$1,940,000	\$1,940,000
		Sub Total NF Feather River Dam		\$1,940,000
60" RCP from Rubber Dam to Caribou PH #1				
60-inch Reinforced Concrete Pipe, Class 3	400	LF	279	\$111,600
Grouted Riprap Slope Protection, 3/8 to 1/4 CY Pieces, 18" Thick	800	SY	120	\$96,352
Excavator, Clamshell, 1/2 CY, wet plus addit. Equip	1363	CY	26	\$34,934
Backfill, 6" layers, roller compaction operator walking	237	CY	44	\$10,376
Compaction, walk behind vibrating plate, 18" wide, 6" lifts, 4 passes	766	CY	3	\$2,321
Pipe bedding, crushed rock, 1/2" to 3/4"	529	CY	48	\$25,540
1/2 CY bucket wheel mounted front end loader, min haul	1090	CY	16	\$17,320

Hauling, 20 mile round trip, 0.4 loads/ hr (Add 15% for Expansion)	1090	CY	27	\$28,994
Sediment and Erosion Control (Silt Fence)	400	LF	5	\$2,024
		Sub total		\$329,000
60" Black Steel Pipe along Concrete Face of Caribou PH #1				
60" black steel pipe	184	LF	572	\$105,248
Drill concrete anchor bolts	184	LF	29	\$5,268
Install concrete anchor bolts	184	LF	25	\$4,659
Drill & Blast restricted areas	109	CY	214	\$23,326
1/2 CY bucket wheel mounted front end loader, min haul	125	CY	16	\$1,986
Hauling, 20 mile round trip, 0.4 loads/ hr (Add 15% for Expansion)	125	CY	27	\$3,325
Anchor rings	4	EACH	800	\$3,200
Precast Storm Drain Manhole, 6' I.D., 8' Deep	2	EACH	4,300	\$8,600
		Sub total		\$156,000
60" RCP from Concrete Face of Caribou PH #1 to N Fork Feather River / Toe of Caribou Road				
60-inch Reinforced Concrete Pipe, Class 3	366	LF	279	\$102,114
Compaction, walk behind vibrating plate, 18" wide, 6" lifts, 4 passes	682	CY	3	\$2,066
Backfill, 6" layers, roller compaction operator walking	198	CY	44	\$8,668
Pipe bedding, crushed rock, 1/2" to 3/4"	484	CY	48	\$23,368
Remove (load) small boulders (under 1/2 CY)	347	CY	17	\$6,062
Replace (load) small boulders (under 1/2 CY)	347	CY	17	\$6,062
Excavator, Clamshell, 1/2 CY, wet plus addit. Equip	597	CY	26	\$15,301
Drill & Blast in restricted areas	596	CY	214	\$127,544
1/2 CY bucket wheel mounted front end loader, min haul	998	CY	\$16	\$15,858
Hauling, 20 mile round trip, 0.4 loads/ hr (Add 15% for Expansion)	998	CY	27	\$26,547
Precast Storm Drain Manhole, 6' I.D., 8' Deep	1	EACH	4,300	\$4,300
Grouted Riprap Slope Protection, 3/8 to 1/4 CY Pieces, 18" Thick	407	SY	120	\$49,019
Sediment and Erosion Control (Silt Fence)	366	LF	5	\$1,852
		Sub total		\$389,000
60" RCP from Toe of Caribou Road to 400 feet Downstream				
60-inch Reinforced Concrete Pipe, Class 3	400	LF	279	\$111,600
Cofferdam, 15-22' Deep, 2 lines of braces, 10" H max	8000	SF	39	\$312,000
Compaction, walk behind vibrating plate, 18" wide, 6" lifts, 4 passes	938	CY	3	\$2,842
Backfill, 6" layers, roller compaction operator walking	409	CY	44	\$17,906
Pipe bedding, crushed rock, 1/2" to 3/4"	529	CY	48	\$25,540
Excavator, Clamshell, 1/2 CY, wet plus addit. Equip	771	CY	26	\$19,761
Drill & Blast in restricted areas	770	CY	214	\$164,780
1/2 CY bucket wheel mounted front end loader, min haul	1090	CY	16	\$17,320
Hauling, 20 mile round trip, 0.4 loads/ hr (Add 15% for Expansion)	1090	CY	27	\$28,994
Precast Storm Drain Manhole, 6' I.D., 8' Deep	1	EACH	4,300	\$4,300

Grouted Riprap Slope Protection, 3/8 to 1/4 CY Pieces, 18" Thick	569	SY	120	\$68,530
Sediment and Erosion Control (Silt Fence)	400	LF	5	2,024
Traffic Control	1	LS	10,000	\$10,000
		Sub total		\$786,000
60" HDPE from Toe of Caribou Road to underwater tie in at dam				
60-inch HDPE	4521	LF	354	\$1,600,434
HDPE Pipe Placement, concrete weight collars / "Float Flood" method, Mechanical Crane, barge mounted	1	LS	961,000	\$961,000
Mechanical Dredging, barge mounted, clamshell, hopper dumped	69622	CY	\$14	\$960,784
Cofferdam, 15-22' Deep, 2 lines of braces, 10" H max	94000	SF	39	\$3,666,000
Furnish and place topsoil, truck dumped, screened, 4" deep	2089	SY	4	\$8,105
Fine grading with seeding inc lime, fertilizer & seed w/ equip.	188000	SF	6	\$1,214,480
Attach to existing plugged inlet structure	1	LS	20,000	\$20,000
60-inch hydraulic operated butterfly valve	1	LS	60,000	\$60,000
Attach hydraulic valve controls to existing sluice gate controls	1	LS	40,000	\$40,000
		Sub total		\$8,531,000
Mobilization				
Dozer, above 150 HP (3)	1	LS	3,600	\$3,600
Excavator, 1-1.5 CY Diesel Hyd. (2)	1	LS	9,600	\$9,600
Loader (2)	1	LS	2,400	\$2,400
Dump truck, 26 tons (10)	1	LS	6,000	\$6,000
25 ton truck mounted hydraulic crane (2)	1	LS	2,000	\$2,000
Crawler Type Drill, 4" (1)	1	LS	700	\$700
Grout pumper (1)	1	LS	600	\$600
Water truck, 6000 gal (1)	1	LS	600	\$600
Wash & Screen (1)	1	LS	7,200	\$7,200
Mechanical Dredger / Crane, barge mounted and all loading equipment	1	LS	200,000	\$200,000
		Sub total Mob / Demob		\$233,000
			TOTAL	\$12,364,000



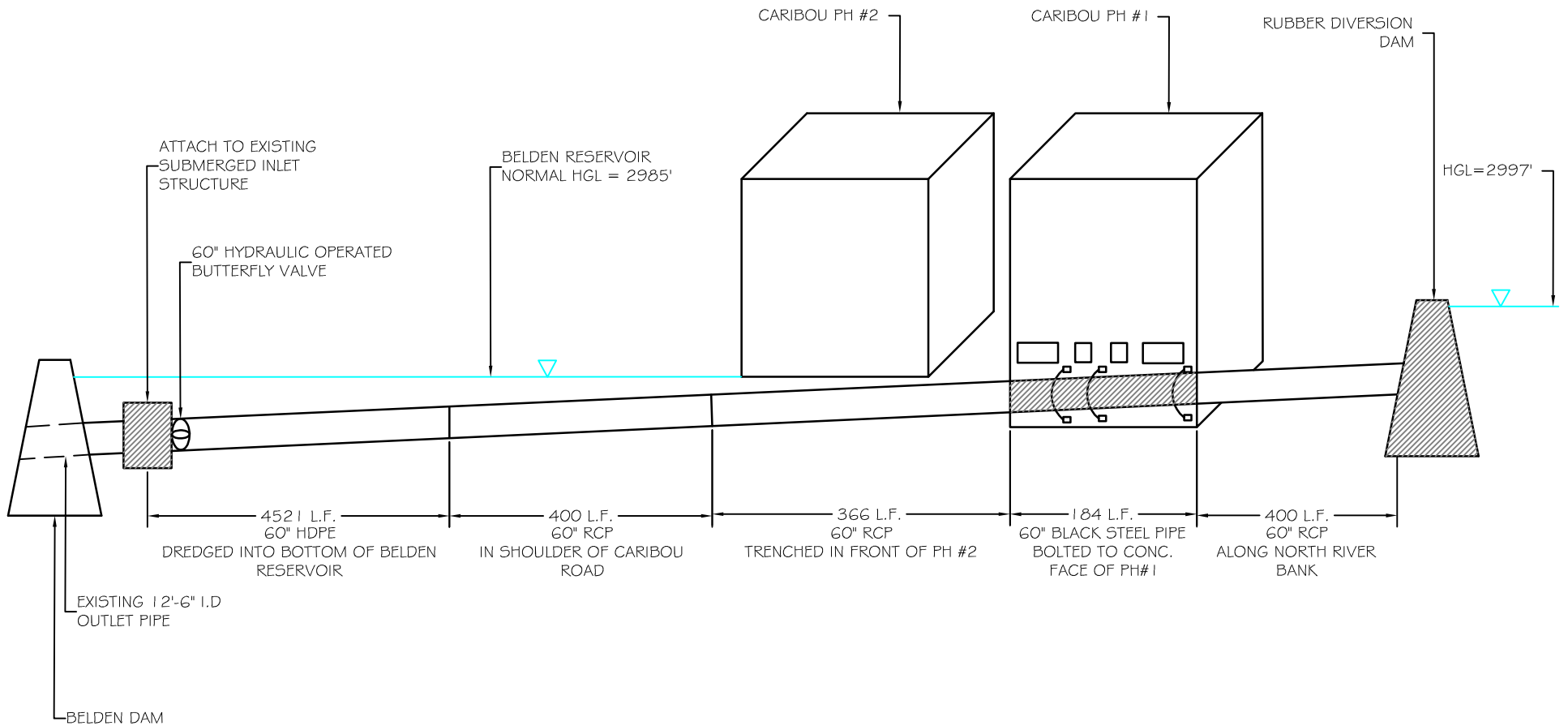
F:\Data\2125\CAD\Figures\BELDENDESIGN.dwg CARIBOU2



***LOWER SENECA REACH BYPASS
TO BELDEN DAM OUTLET***



CARIBOU PH'S #1 & 2 BYPASS TO
BELDEN DAM (250 C.F.S)



Measure Name: Divert Warm Water from East Branch NFFR into a Pipeline to Discharge into Upper Rock Creek Reservoir

Applicable Alternative Category(s): 3, 4, 5a, 6a; additional measure for Belden Reach

Description of Measure: Construct about 1.8-mile long pipeline to convey warm water from East Branch NFFR to discharge into upper Rock Creek Reservoir. The purpose of this measure is to protect the lower Belden Reach from the warming effects of East Branch NFFR inflows.

Description of Operations: This measure does not affect PH operations. According to PG&E's flow measurements in summer 2002-2004, flows in East Branch NFFR during July and August ranged from 45 cfs to 150 cfs, and were less than 100 cfs most of time. A diversion rate of 100 cfs from the East Branch NFFR was used as design flow for this measure. Spill 10 cfs over the rubber dam to maintain instream flow for aquatic habitat in the remaining short reach of the East Branch to the NFFR.

Detailed Description of Facilities Improvements and Design Criteria:

Construct a 3-foot high inflatable/deflatable rubber diversion dam at the lower end of the East Branch NFFR about 300 feet upstream from the NFFR confluence. Except during summer, the rubber dam would remain in the deflated position. Construct an approximately 1.8 mile long, 48-inch RCP pipeline to convey the warm water flows captured behind the dam to discharge into Rock Creek Reservoir. The pipeline discharges through a manually operated butterfly valve to the NFFR just upstream of the Yellow Creek confluence.

Flows in the NFFR above the East Branch during July and August exhibited an average temperature of about 22.5 °C (ranging from 19.9 °C to 26.4 °C), ranged from 45 cfs to 150 cfs, and were less than 100 cfs most of time. These flows would maintain aquatic habitat along the lower Belden Reach.

List of Figures:

- Plan view: East Branch Feather River to Rock Creek Reservoir
- Profile: East Branch to Rock Creek Reservoir

Key Design or Construction Uncertainties Requiring Further Study:

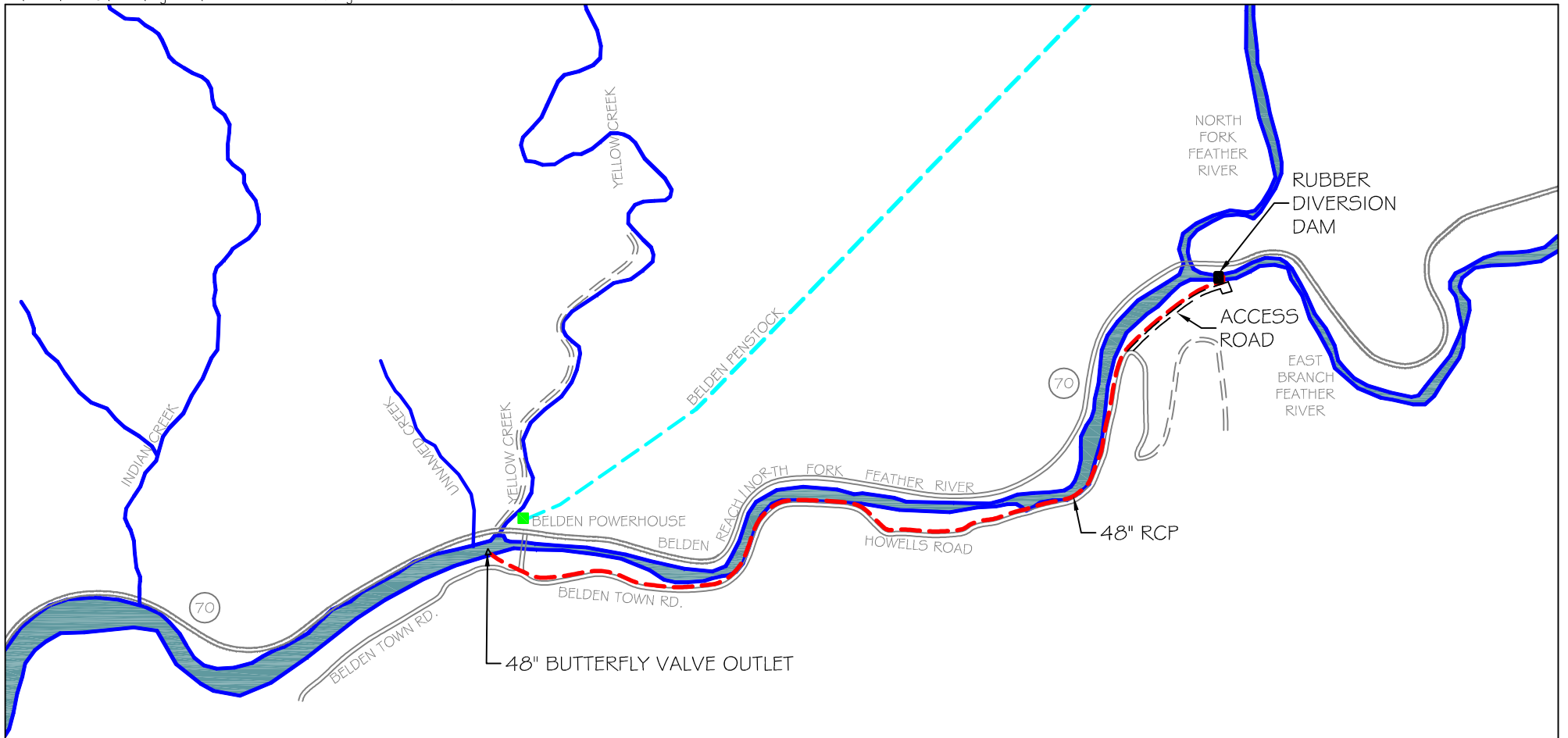
- Construction of the 48-inch reinforced concrete pipe close to the channel along the south bank of the NFFR will be difficult and costly due to boulders and water in the channel.

Discussion:

This measure is slightly different when it is incorporated into alternatives in Alternative Categories 5 and 6. In these alternatives, warm water conveyed from the East Branch NFFR is discharged farther upstream of the Yellow Creek confluence in order to better integrate with the diversion and conveyance of cool lower Belden flows for plunging or bypassing Rock Creek Reservoir.

COST ESTIMATE FOR CONVEYING EAST BRANCH NFFR FLOWS TO UPPER ROCK CREEK RESERVOIR				
ITEM	QUANTITY	UNIT	UNIT COST	COST
RUBBER DAM AND INTAKE				
3' high and 66' wide inflatable rubber dam including: mobilization, site prep, foundation, turnout structure and all necessary materials and construction.	1	LS	\$1,400,000	\$1,400,000
		Sub Total		\$1,400,000
Access Road (1000-foot Access Road from Howells Road)				
Sediment and Erosion Control (Silt Fence)	955	LF	5	\$4,829
Clearing (including Trees), Dozer 300 HP	2334	SY	6	\$13,957
Excavation, Road and Retaining Wall Footings, 1CY Truck Mounted Hydr.	706	CY	13	\$9,501
Hauling, 12 CY Dump Truck, 20-mile RT, 0.4 Loads / Hour	706	CY	38	\$27,133
Concrete for Retaining Wall Footings	39	CY	1,900	\$73,530
Steel Galv. Retaining Wall Posts, 8-Foot	14	EACH	84	\$1,191
Treated Wood for Retaining Wall	28483	BF	12	\$336,636
Fill, 1/2 to 3/4" Crushed Rock	686	CY	47	\$32,376
Fill, Road Surface Gravel	221	CY	36	\$8,010
		Sub Total		\$507,000
48" Pipe From Dam to Howells Road				
48-inch Reinforced Concrete Pipe	2700	LF	104	\$281,232
1/2 CY bucket wheel mounted front end loader, min haul	4140	CY	16	\$65,785
Hauling, 20 mile round trip, 0.4 loads/ hr (Add 15% for Expansion)	4140	CY	27	\$110,124
Compaction, walk behind vibrating plate, 18" wide, 6" lifts, 4 passes	2943	CY	3	\$8,917
Pipe bedding, crushed rock, 1/2" to 3/4"	2343	CY	48	\$113,120
Excavation, truck mounted, 6-10' deep, 1 CY excavator, Hydraulic Jack hammer	4200	CY	12	\$50,400
Grouted Riprap Slope Protection, 3/8 to 1/4 CY Pieces, 18" Thick	80	SY	120	\$9,635
Precast Storm Drain Manhole, 4' I.D., 8' Deep	2	EACH	1,900	\$3,800
		Sub Total		\$643,000
48" Pipe in Howells Road				
48-inch Reinforced Concrete Pipe	6104	LF	104	\$635,793
Sawcut Asphalt, 4" Thick	8400	LF	2	\$19,572
Pavement Removal, Bituminous Roads 4" to 6"	3733	SF	8	\$28,968
Pavement Replacement Over Trench, 4" Thick	3733	SF	35	\$131,626
1/2 CY bucket wheel mounted front end loader, min haul	5665	CY	16	\$90,017
Hauling, 20 mile round trip, 0.4 loads/ hr (Add 15% for Expansion)	5665	CY	27	\$150,689
Compaction, walk behind vibrating plate, 18" wide, 6" lifts, 4 passes	4578	CY	3	\$13,871
Pipe bedding, crushed rock, 1/2" to 3/4"	3645	CY	48	\$175,981

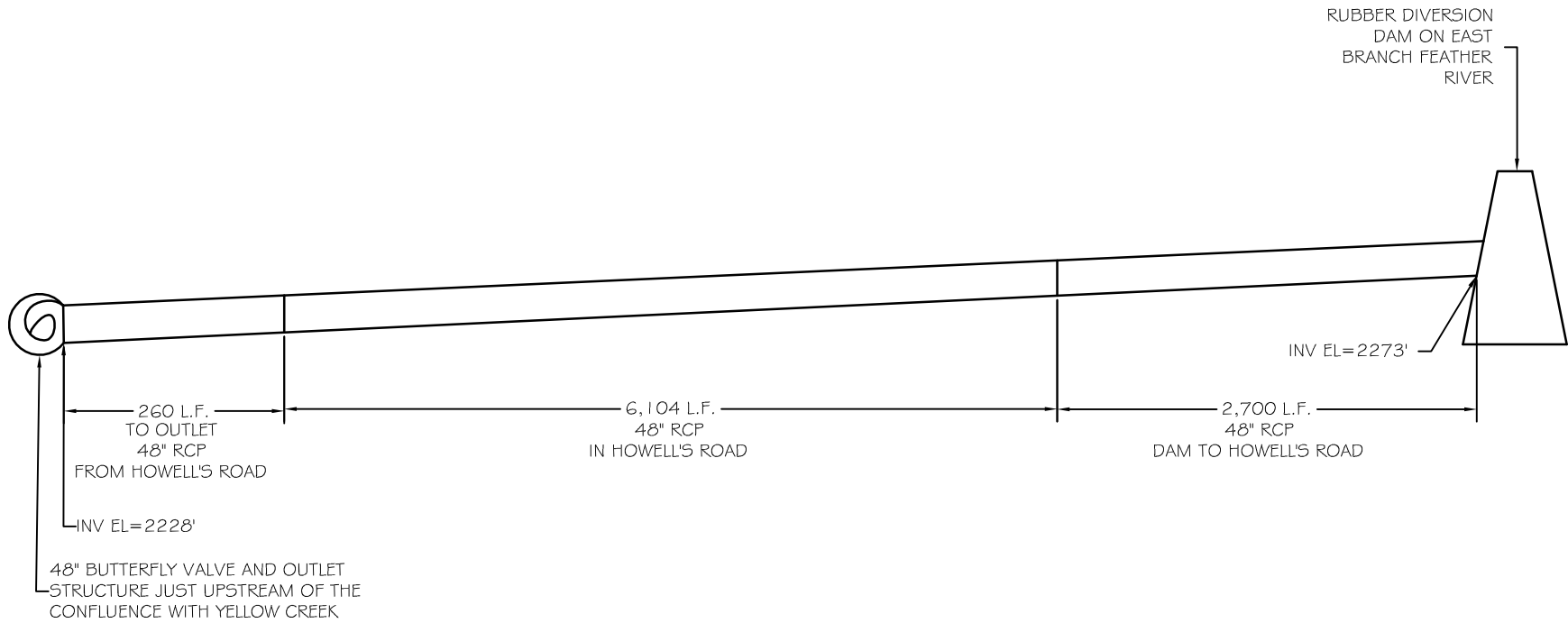
Excavation, truck mounted, 6-10' deep, 1 CY excavator, Hydraulic Jack hammer	6533	CY	12	\$78,396
Precast Storm Drain Manhole, 4' I.D., 8' Deep	6	EACH	1,900	\$11,400
Traffic Control	1	EACH	10,000	\$10,000
		Sub Total		\$1,346,000
48" Pipe from Howells Road to Outlet				
48-inch Reinforced Concrete Pipe	260	LF	104	\$27,082
1/2 CY bucket wheel mounted front end loader, min haul	150	CY	16	\$2,384
Hauling, 20 mile round trip, 0.4 loads/ hr (Add 15% for Expansion)	150	CY	27	\$3,990
Compaction, walk behind vibrating plate, 18" wide, 6" lifts, 4 passes	163	CY	3	\$494
Pipe bedding, crushed rock, 1/2" to 3/4"	130	CY	48	\$6,276
Excavation, truck mounted, 6-10' deep, 1 CY excavator, Hydraulic Jack hammer	233	CY	12	\$2,796
Grouted Riprap Slope Protection, 3/8 to 1/4 CY Pieces, 18" Thick	156	SY	120	\$18,789
48-inch hydraulic operated butterfly valve	1	LS	47,000	\$47,000
Concrete Outlet Structure	10	CY	1,900	\$19,000
Grouted Riprap Slope Protection for Outlet Structure	75	SY	120	\$9,000
		Sub Total		\$137,000
Mobilization				
Dozer, above 150 HP (2)	1	LS	2,400	\$2,400
Excavator, 1-1.5 CY Diesel Hyd. Mobilization	1	EACH	4,800	\$4,800
Loader (2)	1	LS	2,400	\$2,400
Paver Mobilization	1	LS	1,200	\$1,200
Grout pumper (1)	1	LS	600	\$600
Dump truck, 26 tons (4)	1	LS	2,400	\$2,400
Grader, 30,000 lbs (1)	1	LS	1,200	\$1,200
		Sub Total		\$15,000
			TOTAL	\$4,048,000



EAST BRANCH FEATHER RIVER TO ROCK CREEK RESERVOIR



EAST BRANCH TO ROCK CREEK RESERVOIR



Measure Name: Divert Cool Yellow Creek Flow and Convey by Conduit to an Appropriate Plunging Location and Dredge a Submerged Channel in Rock Creek Reservoir

Applicable Alternative Category(s): 5a; additional measure for Rock Creek Reach

Description of Measure: Construct a conduit to convey cool Yellow Creek flows directly to a plunging location in Rock Creek Reservoir, bypassing the Belden PH discharge. The purpose of this measure is to avoid mixing cool Yellow Creek flows with warmer discharges from the Belden PH during operating hours and minimize mixing with warmer ambient waters near the surface of Rock Creek Reservoir. Field observations in Rock Creek Reservoir during the 2006 NFFR special test conducted by PG&E indicate very little thermal stratification in Rock Creek Reservoir suggesting that dredging a channel along the bottom is required to facilitate the transport of cool water through the reservoir.

Description of Operations: This measure does not affect PH operations. At the Yellow Creek dam, divert 60 cfs of cool Yellow Creek flows and spill about 10 cfs to maintain flows for aquatic habitat in the stream over the short distance between the diversion dam and the NFFR/Belden PH confluence.

Detailed Description of Facilities Improvements and Design Criteria:

Construct an inflatable/deflatable 3-foot high rubber diversion dam on Yellow Creek about 1,400 feet upstream of the Belden PH. Except during summer, the rubber dam remains in the deflated position.

The Yellow Creek diversion dam directs 60 cfs through a 54-inch Reinforced Concrete Pipe (RCP) constructed along the bank approximately 1,400 feet to where the pipe transitions into 54-inch HDPE near the NFFR/Yellow Creek confluence. The flow is then conveyed about 7,100 feet through the 54-inch HDPE anchored to the reservoir bottom to a submerged discharge point near the confluence with Chips Creek. A submerged diffuser outlet is installed at the end of the pipeline to distribute the discharge in a larger cross sectional area for the purpose of reducing discharge velocity, turbulence, and mixing potential. Dredge a submerged channel down from the submerged discharge outlet a distance of about 7,000 feet along the bottom of the reservoir to a point near the low level outlet at Rock Creek Dam.

List of Figures:

- Plan view: Yellow Creek to Rock Creek Reservoir
- Profile: Yellow Creek to Rock Creek Reservoir Plunging

Key Design or Construction Uncertainties Requiring Further Study:

- Dredging the reservoir bottom may require removing large boulders which could be difficult and costly.
- The dredged conveyance channel at the bottom of Rock Creek Reservoir will likely fill with sediment and will require repeated dredging.

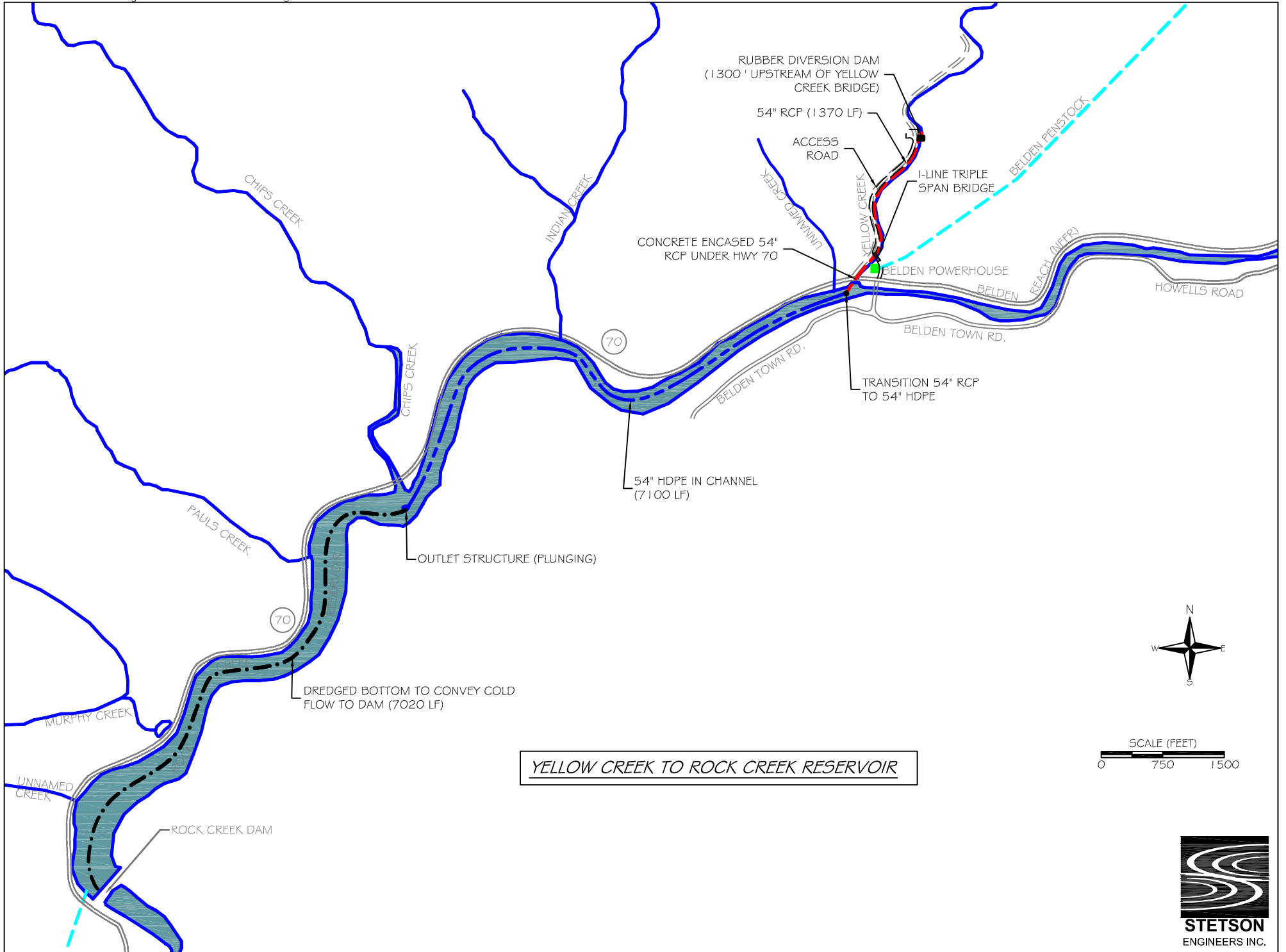
- The effectiveness of cold water transport by a dredged channel in Rock Creek Reservoir requires further study.
- Setting a 54-inch HDPE along the bottom of Rock Creek Reservoir will be difficult and costly. Design and installation of an anchoring system adequate to withstand the potential forces on the pipe arising from flow momentum and land shifting requires further study.

Discussion: None

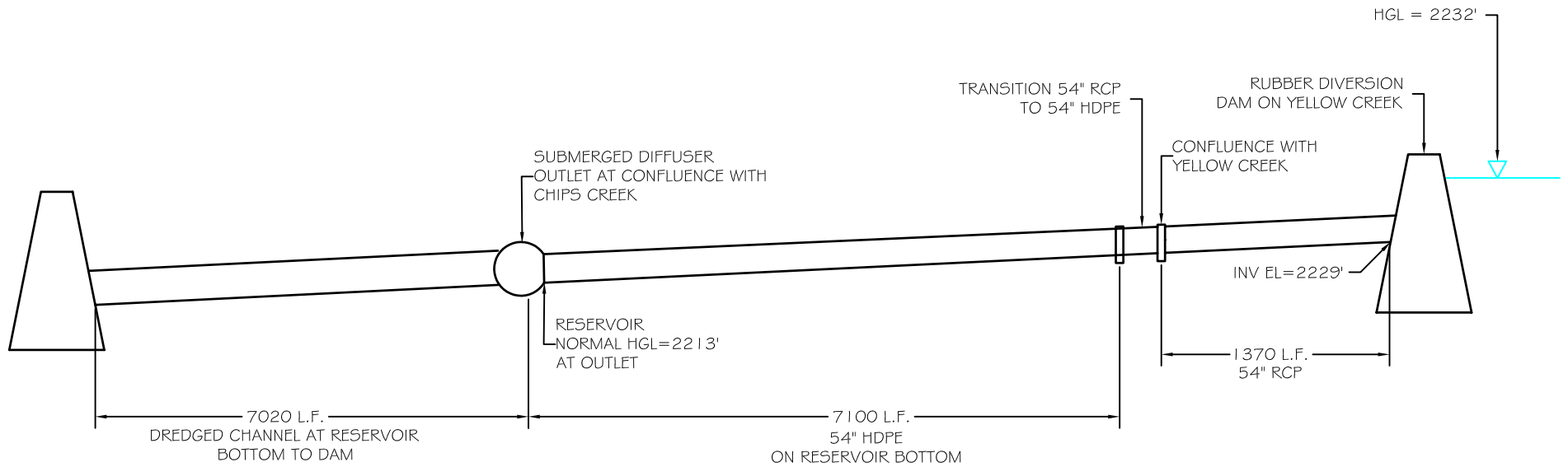
COST ESTIMATE FOR YELLOW CREEK BYPASS TO PLUNGING				
ITEM	QUANTITY	UNIT	UNIT COST	COST
YELLOW CREEK RUBBER DAM AND INTAKE				
3' high and 40' wide inflatable rubber dam including: mobilization, site prep, foundation, turnout structure and all necessary materials and construction.	1	LS	\$850,000	\$850,000
		Sub Total Yellow Creek Dam		\$850,000

Access Road (710-feet along west bank of Yellow Creek)				
Sediment and Erosion Control (Silt Fence)	740	LF	\$5	\$3,744
Clearing (including Trees), Dozer 300 HP	1809	SY	\$6	\$10,819
Excavation, Road and Retaining Wall Footings, 1CY Truck Mounted Hydr.	547	CY	\$13	\$7,365
Hauling, 12 CY Dump Truck, 20-mile RT, 0.4 Loads / Hour	547	CY	\$38	\$21,033
Concrete for Retaining Wall Footings	30	CY	\$1,900	\$57,000
Steel Galv. Retaining Wall Posts, 8-Foot	11	EACH	\$84	\$923
Treated Wood for Retaining Wall	22080	BF	\$12	\$260,958
Fill, 1/2 to 3/4" Crushed Rock	532	CY	\$47	\$25,098
Fill, Road Surface Gravel	171	CY	\$36	\$6,209
24" CMP, corrugated 14 ga.	20	LF	\$50	\$1,009
Triple span, 1 lane bridge over Yellow Creek	1	LS	\$344,000	\$344,000
		Sub total access road		\$738,000
54" Pipe From Rubber Dam to Confluence of Yellow Creek and NF Feather River				
54-inch Reinforced Concrete Pipe, Class 3	1370	LF	\$230	\$315,100
1/2 CY bucket wheel mounted front end loader, min haul	2566	CY	\$16	\$40,774
Hauling, 20 mile round trip, 0.4 loads/ hr (Add 15% for Expansion)	2566	CY	\$27	\$68,256
Compaction, walk behind vibrating plate, 18" wide, 6" lifts, 4 passes	1541	CY	\$3	\$4,669
Pipe bedding, crushed rock, 1/2" to 3/4"	1541	CY	\$48	\$74,399
Excavation, truck mounted, 6-10' deep, 1 CY excavator, Hydraulic Jack hammer	2231	CY	\$12	\$26,772

Precast Storm Drain Manhole, 4' I.D., 8' Deep	4	EACH	\$1,900	\$7,600
Concrete Encasement Under Hwy 70	43	CY	\$1,125	\$48,370
Grouted Riprap Slope Protection, 3/8 to 1/4 CY Pieces, 18" Thick	100	SY	\$120	\$12,044
Sawcut Asphalt, 4" Thick	122	LF	\$2	\$284
Pavement Removal, Bituminous Roads 4" to 6"	396	SF	\$8	\$3,073
Pavement Replacement Over Trench, 4" Thick	396	SF	\$35	\$13,963
Traffic Control	1	EACH	\$5,000	\$5,000
		Sub total 54" RCP		\$620,000
54-Inch HDPE From Confluence of Yellow Creek and NFFR to Chips Creek (With Dredging to Dam)				
54-inch HDPE	2640	LF	\$271	\$715,440
HDPE Pipe Placement, S-lay method with stinger, Mechanical Crane, barge mounted	1	LS	\$1,700,000	\$1,700,000
Mechanical Dredging, barge mounted, clamshell, hopper dumped	130256	CY	\$13	\$1,667,277
Cofferdam, 15-22' Deep, 2 lines of braces, 10" H max	117200	SF	\$39	\$4,570,800
Furnish and place topsoil, truck dumped, screened, 4" deep	39067	SY	\$4	\$151,580
Fine grading with seeding inc lime, fertilizer & seed w/ equip.	351600	SF	\$6	\$2,271,336
Concrete Outlet Diffuser Structure, Structure Pad and Rock Cover	1	LS	\$15,000	\$15,000
		Sub total 54" HDPE		\$11,091,000
Mobilization				
Dozer, above 150 HP (3)	1	LS	\$3,600	\$3,600
Excavator, 1-1.5 CY Diesel Hyd. (2)	1	LS	\$9,600	\$9,600
Loader (2)	1	LS	\$2,400	\$2,400
Paver Mobilization	1	LS	\$1,200	\$1,200
Grout pumper (1)	1	LS	\$600	\$600
Mechanical Dredger, Crane and stinger, barge mounted and all equipment	1	LS	\$200,000	\$200,000
		Sub total Mob / Demob		\$217,000
			TOTAL	\$13,516,000



YELLOW CREEK TO ROCK CREEK RESERVOIR PLUNGING



Measure Name: Divert Cool Yellow Creek Flows into a Pipeline to Discharge below Rock Creek Dam

Applicable Alternative Category(s): 4, 5; additional measure for Rock Creek Reach

Description of Measure: Construct about 3-mile long pipeline to convey cool Yellow Creek flows to below Rock Creek Dam directly, bypassing Rock Creek Reservoir. The purpose of this measure is to avoid mixing cool Yellow Creek flows with warmer discharges from the Belden PH during operational hours and minimize mixing of Yellow Creek flows with warmer ambient waters near the surface of Rock Creek Reservoir.

Description of Operations: This measure does not affect PH operations. According to PG&E's flow measurements in summer 2002-2004, Yellow Creek discharges during July and August ranged from about 50 cfs to 100 cfs, with most of time less than 70 cfs. Operate the Yellow Creek diversion system to divert and convey about 60 cfs while spilling about 10 cfs over the diversion dam to maintain flows for aquatic habitat in the short reach to the Yellow Creek/Belden PH confluence.

Detailed Description of Facilities Improvements and Design Criteria:

Construct an inflatable/deflatable rubber diversions dam on Yellow Creek. Construct the 3-foot high rubber dam about 1,400 feet upstream of the Belden PH. Except during summer, the rubber dam will remain in the deflated position.

The Yellow Creek diversion dam directs 60 cfs through a 42-inch Reinforced Concrete Pipe (RCP) conduit. The RCP is buried under a newly constructed access road that extends to Highway 70. Downstream of Yellow Creek the pipe is buried along shoulder of Highway 70 for approximately 6,900 feet to the confluence of Chips Creek.

The Yellow Creek flow is conveyed in 42-inch Black Steel Pipe (BSP) over Chips Creek which is attached to the Chips Creek Bridge and transitions back into 42-inch RCP for a distance of 7,893 feet to the top of Rock Creek Dam. The conduit then transitions back to 42-inch BSP and is connected with rock anchors to the steep rock face on the southwest side of the dam for 155 feet to discharge through a manually operated butterfly valve to the Rock Creek Reach.

The design and costs associated with the Yellow Creek temporary access road as well as the connected steel pipe and stair tower down to the toe of Rock Creek Dam were derived from the 2005 Black and Veatch Summary Report (North Fork Feather River Yellow Creek Diversion Cooling Water Pipeline Feasibility Report, 2005).

List of Figures:

- Plan view: Yellow Creek Diversion to Rock Creek Dam
- Profile: Yellow Creek Diversion to Rock Creek Dam Outlet

Key Design or Construction Uncertainties Requiring Further Study:

- Attaching a bridge crossing structure and steel pipeline to the existing Highway 70 bridge over Chips Creek could make the existing structure unstable and will require further study.
- Connecting 155 LF of 42-inch Black Steel Pipe to the steep rock face at the dam requires further study.

Discussion: None

COST ESTIMATE FOR YELLOW CREEK BYPASS TO ROCK CREEK DAM				
ITEM	QUANTITY	UNIT	UNIT COST	COST
YELLOW CREEK RUBBER DAM AND INTAKE				
3' high and 40' wide inflatable rubber dam including: mobilization, site prep, foundation, turnout structure and all necessary materials and construction.	1	LS	\$850,000	\$850,000
		Sub Total Yellow Creek Dam		\$850,000
Access Road (710-feet along west bank of Yellow Creek)				
Sediment and Erosion Control (Silt Fence)	740	LF	\$5	\$3,744
Clearing (including Trees), Dozer 300 HP	1809	SY	\$6	\$10,819
Excavation, Road and Retaining Wall Footings, 1CY Truck Mounted Hydr.	547	CY	\$13	\$7,365
Hauling, 12 CY Dump Truck, 20-mile RT, 0.4 Loads / Hour	547	CY	\$38	\$21,033
Concrete for Retaining Wall Footings	30	CY	\$1,900	\$58,139
Steel Galv. Retaining Wall Posts, 8-Foot	11	EACH	\$80	\$923
Treated Wood for Retaining Wall	22080	BF	\$12	\$260,958
Fill, 1/2 to 3/4" Crushed Rock	532	CY	\$47	\$25,098
Fill, Road Surface Gravel	171	CY	\$36	\$6,209
24" CMP, corrugated 14 ga.	20	LF	\$50	\$1,009
Triple span, 1 lane bridge over Yellow Creek	1	LS	\$340,000	\$340,000
		Sub total access road + bridge		\$735,000
42" Pipe From Yellow Creek Dam to south side of Hwy 70 at confluence with NFFR				
42-inch Reinforced Concrete Pipe, Class 3	1400	LF	\$132	\$184,800
1/2 CY bucket wheel mounted front end loader, min haul	3354	CY	\$16	\$53,295
Hauling, 20 mile round trip, 0.4 loads/ hr (Add 15% for Expansion)	3354	CY	\$27	\$89,216
Backfill, 6" layers, roller compaction operator walking	1167	CY	\$44	\$51,091

Pipe bedding, crushed rock, 1/2" to 3/4"	1685	CY	\$48	\$81,352
Excavation, truck mounted, 6-10' deep, 1 CY excavator, Hydraulic Jack hammer	4083	CY	\$12	\$48,996
Precast Storm Drain Manhole, 5' I.D., 8' Deep	4	EACH	\$3,000	\$11,176
Concrete Encasement Under Hwy 70	65	CY	\$1,100	\$73,118
Grouted Riprap Slope Protection, 3/8 to 1/4 CY Pieces, 18" Thick	100	SY	\$120	\$12,044
Sawcut Asphalt, 4" Thick	122	LF	\$2	\$284
Pavement Removal, Bituminous Roads 4" to 6"	396	SF	\$8	\$3,073
Pavement Replacement Over Trench, 4" Thick	396	SF	\$35	\$13,963
Traffic Control	1	EACH	\$5,000	\$5,000
		Sub total		\$627,000
42" Pipe From south side of Hwy 70 at confluence with NFFR to Chips Creek				
Clearing, medium	1	ACRE	\$1,400	\$1,400
42-inch Reinforced Concrete Pipe, Class 3	6913	LF	\$132	\$912,516
1/2 CY bucket wheel mounted front end loader, min haul	16562	CY	\$16	\$263,170
Hauling, 20 mile round trip, 0.4 loads/ hr (Add 15% for Expansion)	16562	CY	\$27	\$440,549
Backfill, 6" layers, roller compaction operator walking	5761	CY	\$44	\$252,217
Pipe bedding, crushed rock, 1/2" to 3/4"	8319	CY	\$48	\$401,641
Excavation, truck mounted, 6-10' deep, 1 CY excavator, Hydraulic Jack hammer	20163	CY	\$12	\$241,956
Remove Gravel shoulder	1874	SY	\$7	\$12,481
Replace Gravel shoulder	625	CY	\$48	\$30,175
Grouted Riprap Slope Protection, 3/8 to 1/4 CY Pieces, 18" Thick	9471	SY	\$120	\$1,140,687
Sediment and Erosion Control (Silt Fence)	6913	LF	\$5	\$34,980
Remove and reset existing corrugated metal guard rail (includes all guard rail on 70)	12940	LF	\$35	\$449,277
Precast Storm Drain Manhole, 5' I.D., 8' Deep	20	EACH	\$3,000	\$60,000
Traffic control, signage (includes traffic cont. down to dam)	1	LS	\$30,000	\$30,000
Traffic control, 2 signals (includes traffic cont. down to dam)	1	LS	\$380,000	\$380,000
		Sub total		\$4,651,000
Chips Creek at Hwy 70 to top of Rock Creek Dam				
Clearing, medium	1	ACRE	\$1,400	\$1,400
42-inch Reinforced Concrete Pipe, Class 3	7893	LF	\$132	\$1,041,876
Excavation, truck mounted, 6-10' deep, 1 CY excavator, Hydraulic Jack hammer	28576	CY	\$12	\$342,912
1/2 CY bucket wheel mounted front end loader, min haul	24289	CY	\$16	\$385,952
Backfill, 6" layers, roller compaction operator walking	7455	CY	\$44	\$326,380
Pipe bedding, crushed rock, 1/2" to 3/4"	11421	CY	\$48	\$551,406
Hauling, 20 mile round trip, 0.4 loads/ hr (Add 15% for Expansion)	24289	CY	\$27	\$646,087
Precast Storm Drain Manhole, 6' I.D., 8' Deep	34	EACH	\$4,000	\$136,000
Grouted Riprap Slope Protection, 3/8 to 1/4 CY Pieces, 18" Thick	11690	SY	\$120	\$1,407,944

Remove Gravel shoulder	2140	SY	\$7	\$14,252
Replace Gravel shoulder	713	CY	\$48	\$34,424
Sediment and Erosion Control (Silt Fence)	7893	LF	\$5	\$39,939
Sub Total				\$4,929,000

Top of Rock Creek Dam to Outlet				
42" black steel pipe	155	LF	\$354	\$54,870
Rock excavation, drill and blast	11	CY	\$128	\$1,412
Drill rock anchor bolts	494	LF	\$29	\$14,143
Install rock anchor bolts	480	LF	\$25	\$12,154
Anchor rings	5	EACH	\$800	\$4,000
Stair tower (Down to base of dam)	1	LS	\$224,000	224,000
42-inch hydraulic operated butterfly valve	1	LS	40,000	\$40,000
Sub total				\$351,000

Indian Creek Crossing				
Cast in place 10.5'W x 1.5'H x 16'L Reinforced Concrete Box Culvert	8	CY	\$2,770	\$22,160
Cast in place culvert transitions to 42" pipe	3	CY	\$2,770	\$8,310
Structural excavation	84	CY	\$46	\$3,864
1/2 CY bucket wheel mounted front end loader, min haul	97	CY	\$16	\$1,541
Hauling, 20 mile round trip, 0.4 loads/ hr (Add 15% for Expansion)	97	CY	\$27	\$2,580
Backfill and roller compaction operator walking	9	CY	\$44	\$394
Remove Gravel shoulder	6	SY	\$7	\$40
Replace Gravel shoulder	2	CY	\$48	\$97
Bedding, crushed rock, 1/2" to 3/4"	7	CY	\$49	\$345
Clearing	1	LS	\$500	\$500
Grouted Riprap Slope Protection, 3/8 to 1/4 CY Pieces, 18" Thick	28	SY	\$120	\$3,372
Sub total				\$43,000

Various Small Culverts (3) Upstream of Chips Creek				
Cast in place 10.5'W x 1.5'H x 6'L Reinforced Concrete Box Culverts	9	CY	\$2,770	\$24,930
Cast in place culvert transitions to pipe	9	CY	\$2,770	\$24,930
Structural excavation	148	CY	\$46	\$6,808
1/2 CY bucket wheel mounted front end loader, min haul	170	CY	\$16	\$2,701
Hauling, 20 mile round trip, 0.4 loads/ hr (Add 15% for Expansion)	170	CY	\$27	\$4,522
Backfill and roller compaction operator walking	16	CY	\$44	\$700
Remove Gravel shoulder	11.5	SY	\$7	\$77
Replace Gravel shoulder	4	CY	\$48	\$193
Bedding, crushed rock, 1/2" to 3/4"	12	CY	\$49	\$591
Clearing	1	LS	\$1,500	\$1,500
Grouted Riprap Slope Protection, 3/8 to 1/4 CY	47.8	SY	\$120	\$5,757

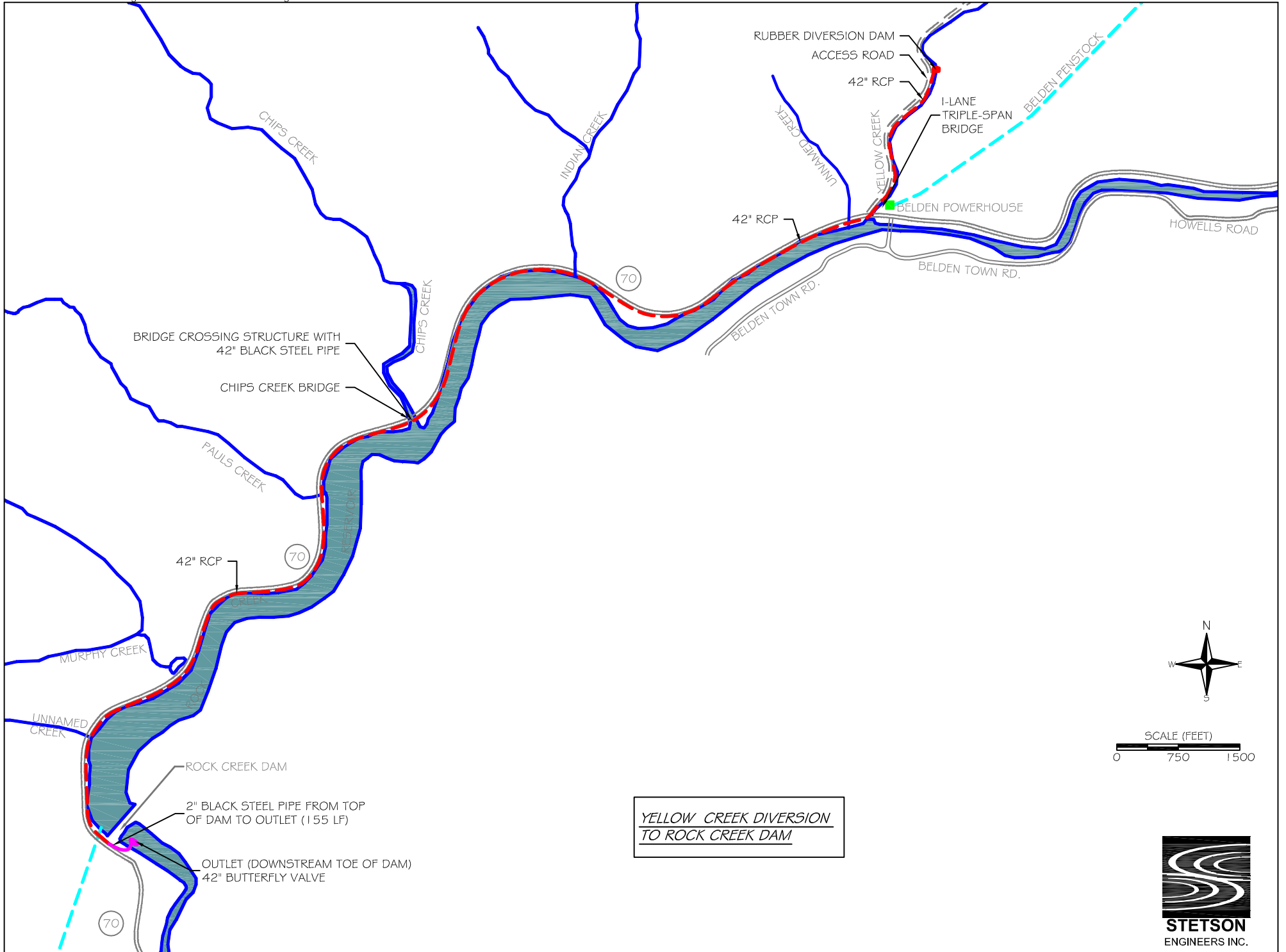
Pieces, 18" Thick				
		Sub total		\$73,000

Chips Creek Crossing				
42" black steel pipe	130	LF	\$354	\$46,020
Concrete pier footing, piers, pier caps and abutments	19	CY	\$1,800	\$33,558
Pier and abutment excavation	18	CY	\$46	\$828
Structural steel	12	TONS	\$3,200	\$38,400
Structural steel, pier supports	3	TONS	\$4,300	\$12,900
Steel, anchor rings	5	EACH	\$800	\$4,000
Sediment and Erosion Control (Silt Fence)	130	LF	\$5	\$658
Clearing	1	LS	\$500	\$500
Excavation, truck mounted, 6-10' deep, 1 CY excavator, Hydraulic Jack hammer	43	CY	\$12	\$516
Backfill, 6" layers, roller compaction operator walking	18	CY	\$44	\$788
Grouted Riprap Slope Protection, 3/8 to 1/4 CY Pieces, 18" Thick	18	SY	\$120	\$2,168
Hauling, 20 mile round trip, 0.4 loads/ hr (Add 15% for Expansion)	38	CY	\$27	\$1,011
Remove Gravel shoulder	3	SY	\$7	\$20
Replace Gravel shoulder	1	CY	\$48	\$48
Bedding, crushed rock, 1/2" to 3/4"	17	CY	\$48	\$821
		Sub total		\$142,000

Paul's and Murphy's Creek Crossing (downstream of Chips Creek)				
Cast in place 13'W x 1.5'H x 9'L Reinforced Concrete Box Culverts	11	CY	\$2,770	\$30,470
Cast in place culvert transitions to pipe	7	CY	\$2,770	\$19,390
Structural excavation	149	CY	\$46	\$6,854
1/2 CY bucket wheel mounted front end loader, min haul	171	CY	\$16	\$2,717
Hauling, 20 mile round trip, 0.4 loads/ hr (Add 15% for Expansion)	171	CY	\$27	\$4,549
Backfill and roller compaction operator walking	15	CY	\$44	\$657
Remove Gravel shoulder	9	SY	\$7	\$60
Replace Gravel shoulder	3	CY	\$48	\$145
Bedding, crushed rock, 1/2" to 3/4"	12	CY	\$48	\$579
Clearing	1	LS	\$1,000	\$1,000
Grouted Riprap Slope Protection, 3/8 to 1/4 CY Pieces, 18" Thick	39	SY	\$120	\$4,697
		Sub total		\$71,000

Various Small Culverts (2) Downstream of Chips Creek				
Cast in place 13'W x 1.5'H x 6'L Reinforced Concrete Box Culverts	7.4	CY	\$2,770	\$20,498
Cast in place culvert transitions to pipe	7.4	CY	\$2,770	\$20,498
Structural excavation	122	CY	\$46	\$5,612
1/2 CY bucket wheel mounted front end loader, min haul	140	CY	\$16	\$2,225

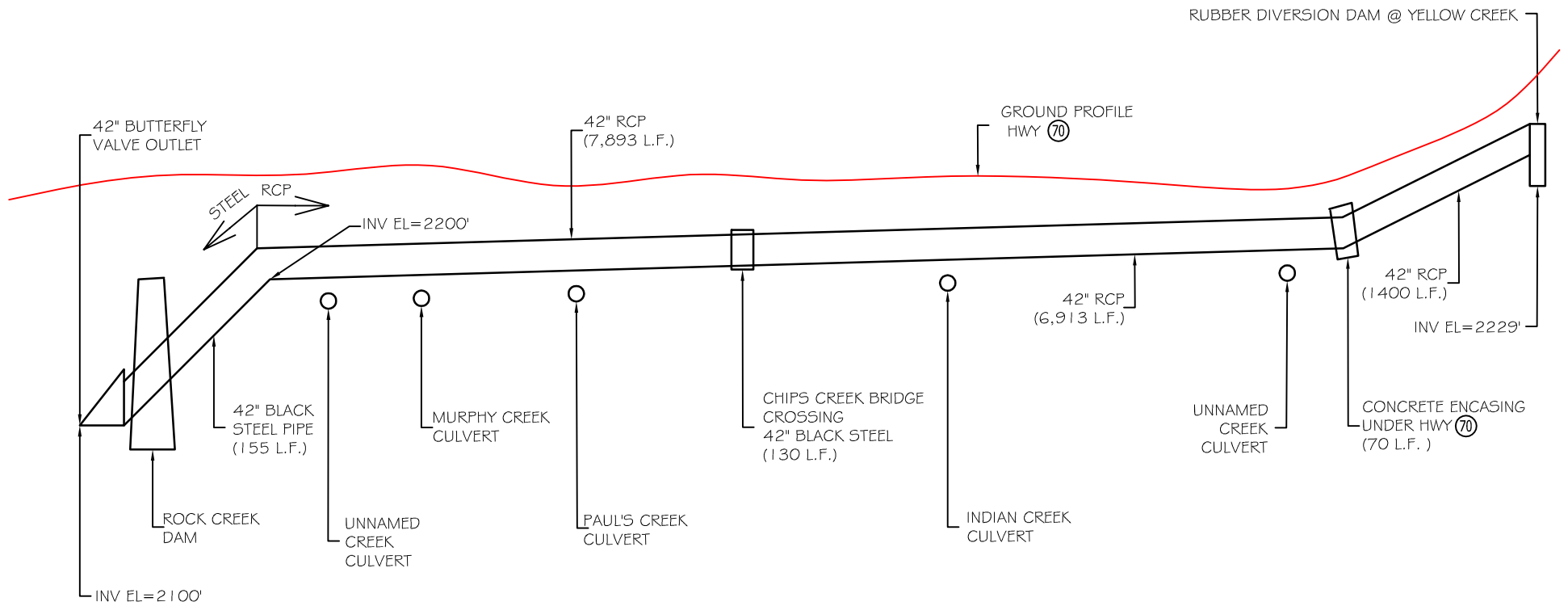
Hauling, 20 mile round trip, 0.4 loads/ hr (Add 15% for Expansion)	140	CY	\$27	\$3,724
Backfill and roller compaction operator walking	13	CY	\$44	\$569
Remove Gravel shoulder	8	SY	\$7	\$53
Replace Gravel shoulder	3	CY	\$48	\$145
Bedding, crushed rock, 1/2" to 3/4"	10	CY	\$49	\$493
Clearing	1	LS	\$1,500	\$1,500
Grouted Riprap Slope Protection, 3/8 to 1/4 CY Pieces, 18" Thick	32	SY	\$120	\$3,854
		Sub total		\$59,000
Mobilization / Demobilization				
Dozer, above 150 HP (3)	1	LS	\$3,600	\$3,600
Excavator, 1-1.5 CY Diesel Hyd. (2)	1	LS	\$9,600	\$9,600
Loader (2)	1	LS	\$2,400	\$2,400
Dump truck, 26 tons (10)	1	LS	\$6,000	\$6,000
25 ton truck mounted hydraulic crane (2)	1	LS	\$2,000	\$2,000
Crawler Type Drill, 4" (1)	1	LS	\$700	\$700
Grader, 30,000 lbs (2)	1	LS	\$2,400	\$2,400
Grout pumper (1)	1	LS	\$600	\$600
Water truck, 6000 gal (2)	1	LS	\$1,200	\$1,200
Wash & Screen (1)	1	LS	\$7,200	\$7,200
		Sub total		\$36,000
Total				\$12,567,000



YELLOW CREEK DIVERSION
TO ROCK CREEK DAM



YELLOW CREEK DIVERSION TO ROCK CREEK DAM OUTLET



Measure Name: Divert Cool Yellow Creek and Chips Creek Flows into a Pipeline to Discharge below Rock Creek Dam

Applicable Alternative Category(s): 4, 5; additional measure for Rock Creek Reach

Description of Measure: Construct about 3-mile long pipeline to convey cool Yellow Creek and Chips Creek flows to below Rock Creek Dam directly, bypassing Rock Creek Reservoir. The purpose of this measure is to avoid mixing cool Yellow Creek flows with warmer discharges from the Belden PH during operational hours and minimize mixing of Yellow Creek and Chips Creek flows with warmer ambient waters near the surface of Rock Creek Reservoir.

Description of Operations: This measure does not affect PH operations. According to PG&E's flow measurements in summer 2002-2004, Yellow Creek discharges during July and August ranged from about 50 cfs to 100 cfs, with most of time less than 70 cfs. Chips Creek discharges during July and August ranged from about 15 cfs to 50 cfs, with most of time less than 30 cfs. Operate the Yellow Creek diversion system to divert and convey about 60 cfs while spilling about 10 cfs over the diversion dam to maintain flows for aquatic habitat in the short reach to the Yellow Creek/Belden PH confluence. Operate the Chips Creek diversion system to divert and convey about 20 cfs while spilling about 3 cfs over the diversion dam to maintain flows for aquatic habitat in the short reach to Rock Creek Reservoir.

Detailed Description of Facilities Improvements and Design Criteria:

Construct two inflatable/deflatable rubber diversions dams; one on Yellow Creek and another on Chips Creek. On Yellow Creek, construct a 3-foot high rubber about 1,400 feet upstream of the Belden PH. On Chips Creek construct a 3-foot high rubber about 740 feet upstream of Highway 70 above Rock Creek Reservoir. Except during summer, the rubber dams remain in the deflated position.

The Yellow Creek diversion dam directs 60 cfs through a 54-inch Reinforced Concrete Pipe (RCP) conduit. The RCP is buried under a newly constructed access road that extends to Highway 70. Downstream of Yellow Creek the pipe is buried along shoulder of Highway 70 for approximately 6,900 feet to the confluence of Chips Creek.

The Chips Creek diversion dam directs 20 cfs through a 18-inch RCP which is buried for a distance of about 740 feet along the east bank of Chips Creek. The Yellow Creek and Chips Creek RCPs join at a tie-in structure at Highway 70. The combined 80 cfs is conveyed in 60-inch Black Steel Pipe (BSP) that is attached to the Chips Creek Bridge over Chips Creek and transitions back into 60-inch RCP for a distance of 7,893 feet to the top of Rock Creek Dam. The conduit then transitions back to 60-inch BSP and is connected with rock anchors to the steep rock face on the southwest side of the dam for 155 feet to discharge through a manually operated butterfly valve to the Rock Creek Reach.

The design and costs associated with the Yellow Creek temporary access road as well as the bolted steel pipe and stair tower down to the toe of Rock Creek Dam were derived from the 2005 Black and Veatch Summary Report (North Fork Feather River Yellow Creek Diversion Cooling Water Pipeline Feasibility Report, 2005)

List of Figures:

- Plan view: Yellow and Chips Creek Diversion to Rock Creek Dam
- Profile: Yellow and Chips Creek Diversion to Rock Creek Dam

Key Design or Construction Uncertainties Requiring Further Study:

- Attaching a bridge crossing structure and steel pipeline to the existing Highway 70 bridge over Chips Creek could make the existing structure unstable and will require further study.
- Connecting 155 LF of 60-inch Black Steel Pipe to the steep rock face at the dam requires further study.

Discussion: None

COST ESTIMATE FOR YELLOW CREEK/ CHIPS CREEK BYPASS TO ROCK CREEK DAM				
ITEM	QUANTITY	UNIT	UNIT COST	COST
YELLOW CREEK RUBBER DAM AND INTAKE				
3' high and 40' wide inflatable rubber dam including: mobilization, site prep, foundation, turnout structure and all necessary materials and construction.	1	LS	\$850,000	\$850,000
		Sub Total Yellow Creek Dam		\$850,000
Access Road (710-feet along west bank of Yellow Creek)				
Sediment and Erosion Control (Silt Fence)	740	LF	\$5	\$3,744
Clearing (including Trees), Dozer 300 HP	1809	SY	\$6	\$10,819
Excavation, Road and Retaining Wall Footings, 1CY Truck Mounted Hydr.	547	CY	\$13	\$7,365
Hauling, 12 CY Dump Truck, 20-mile RT, 0.4 Loads / Hour	547	CY	\$38	\$21,033
Concrete for Retaining Wall Footings	30	CY	\$1,900	\$58,139
Steel Galv. Retaining Wall Posts, 8-Foot	11	EACH	\$80	\$923
Treated Wood for Retaining Wall	22080	BF	\$12	\$260,958
Fill, 1/2 to 3/4" Crushed Rock	532	CY	\$47	\$25,098
Fill, Road Surface Gravel	171	CY	\$36	\$6,209
24" CMP, corrugated 14 ga.	20	LF	\$50	\$1,009
Triple span, 1 lane bridge over Yellow Creek	1	LS	\$340,000	\$340,000
		Sub total access road + bridge		\$735,000
54" Pipe From Yellow Creek Dam to south side of Hwy 70 at confluence with NFFR				
54-inch Reinforced Concrete Pipe, Class 3	1400	LF	\$230	\$322,000
1/2 CY bucket wheel mounted front end loader, min haul	3354	CY	\$16	\$53,295
Hauling, 20 mile round trip, 0.4 loads/ hr (Add 15% for Expansion)	3354	CY	\$27	\$89,216
Backfill, 6" layers, roller compaction operator walking	1167	CY	\$44	\$51,091
Pipe bedding, crushed rock, 1/2" to 3/4"	1685	CY	\$48	\$81,352
Excavation, truck mounted, 6-10' deep, 1 CY excavator, Hydraulic Jack hammer	4083	CY	\$12	\$48,996
Precast Storm Drain Manhole, 5' I.D., 8' Deep	4	EACH	\$3,000	\$11,176
Concrete Encasement Under Hwy 70	65	CY	\$1,100	\$73,118
Grouted Riprap Slope Protection, 3/8 to 1/4 CY Pieces, 18" Thick	100	SY	\$120	\$12,044
Sawcut Asphalt, 4" Thick	122	LF	\$2	\$284
Pavement Removal, Bituminous Roads 4" to 6"	396	SF	\$8	\$3,073
Pavement Replacement Over Trench, 4" Thick	396	SF	\$35	\$13,963
Traffic Control	1	EACH	\$5,000	\$5,000
		Sub total		\$765,000

54" Pipe From south side of Hwy 70 at confluence with NFFR to tie in at Chips Creek				
Clearing, medium	1	ACRE	\$1,400	\$1,400
54-inch Reinforced Concrete Pipe, Class 3	6913	LF	\$230	\$1,589,990
1/2 CY bucket wheel mounted front end loader, min haul	16562	CY	\$16	\$263,170
Hauling, 20 mile round trip, 0.4 loads/ hr (Add 15% for Expansion)	16562	CY	\$27	\$440,549
Backfill, 6" layers, roller compaction operator walking	5761	CY	\$44	\$252,217
Pipe bedding, crushed rock, 1/2" to 3/4"	8319	CY	\$48	\$401,641
Excavation, truck mounted, 6-10' deep, 1 CY excavator, Hydraulic Jack hammer	20163	CY	\$12	\$241,956
Remove Gravel shoulder	1874	SY	\$7	\$12,481
Replace Gravel shoulder	625	CY	\$48	\$30,175
Grouted Riprap Slope Protection, 3/8 to 1/4 CY Pieces, 18" Thick	9471	SY	\$120	\$1,140,687
Sediment and Erosion Control (Silt Fence)	6913	LF	\$5	\$34,980
Remove and reset existing corrugated metal guard rail (includes all guard rail on 70)	12940	LF	\$35	\$449,277
Precast Storm Drain Manhole, 5' I.D., 8' Deep	20	EACH	\$3,000	\$60,000
Traffic control, signage (includes traffic cont. down to dam)	1	LS	\$30,000	\$30,000
Traffic control, 2 signals (includes traffic cont. down to dam)	1	LS	\$380,000	\$380,000
		Sub total		\$5,329,000
CHIPS CREEK RUBBER DAM AND INTAKE				
3' high and 40' wide inflatable rubber dam including: mobilization, site prep, foundation, turnout structure and all necessary materials and construction.	1	LS	\$850,000	\$850,000
		Sub Total Chips Creek Dam		\$850,000
Chips Creek Dam to tie in at Hwy 70				
18-inch Reinforced Concrete Pipe, Class 3	740	LF	\$37	\$27,698
Excavation, truck mounted, 6-10' deep, 1 CY excavator, Hydraulic Jack hammer	925	CY	\$12	\$11,100
1/2 CY bucket wheel mounted front end loader, min haul	638	CY	\$16	\$10,138
Hauling, 20 mile round trip, 0.4 loads/ hr (Add 15% for Expansion)	638	CY	\$27	\$16,971
Pipe bedding, crushed rock, 1/2" to 3/4"	420	CY	\$48	\$20,278
Compaction, walk behind vibrating plate, 18" wide, 6" lifts, 4 passes	790	CY	\$3	\$2,394
Precast Storm Drain Manhole, 5' I.D., 8' Deep	2	EACH	\$3,000	\$6,000
Excavate and load on truck, bank measure. Bucket drag line 3/4 CY, sand & gravel	397	CY	\$4	\$1,632
Temporary road, gravel fill, no surfacing, 6" gravel depth (10' wide)	794	SY	\$11	\$8,790
Hand grade select gravel, including compaction, 6" deep (10' wide)	794	SY	\$3	\$2,453
Concrete Encasement Under Hwy 70	39	CY	\$1,100	\$43,871
Sawcut Asphalt, 4" Thick	80	LF	\$2	\$186
Pavement Removal, Bituminous Roads 4" to 6"	240	SF	\$8	\$1,862
Pavement Replacement Over Trench, 4" Thick	240	SF	\$35	\$8,462
Traffic Control	1	EACH	\$5,000	\$5,000

Tie in structure, 18" and 54" RCP in, 60" RCP out	1	LS	\$5,000	\$5,000
		Sub Total		\$172,000
Tie in at Hwy 70 to top of Rock Creek Dam				
Clearing, medium	1	ACRE	\$1,400	\$1,400
60-inch Reinforced Concrete Pipe, Class 3	7893	LF	\$279	\$2,200,963
Excavation, truck mounted, 6-10' deep, 1 CY excavator, Hydraulic Jack hammer	28576	CY	\$12	\$342,912
1/2 CY bucket wheel mounted front end loader, min haul	24289	CY	\$16	\$385,952
Backfill, 6" layers, roller compaction operator walking	7455	CY	\$44	\$326,380
Pipe bedding, crushed rock, 1/2" to 3/4"	11421	CY	\$48	\$551,406
Hauling, 20 mile round trip, 0.4 loads/ hr (Add 15% for Expansion)	24289	CY	\$27	\$646,087
Precast Storm Drain Manhole, 6' I.D., 8' Deep	34	EACH	\$4,000	\$136,000
Grouted Riprap Slope Protection, 3/8 to 1/4 CY Pieces, 18" Thick	11690	SY	\$120	\$1,407,944
Remove Gravel shoulder	2140	SY	\$7	\$14,252
Replace Gravel shoulder	713	CY	\$48	\$34,424
Sediment and Erosion Control (Silt Fence)	7893	LF	\$5	\$39,939
		Sub Total		\$6,088,000

Top of Rock Creek Dam to Outlet				
60" black steel pipe	155	LF	\$572	\$88,660
Rock excavation, drill and blast	11	CY	\$128	\$1,412
Drill rock anchor bolts	494	LF	\$29	\$14,143
Install rock anchor bolts	480	LF	\$25	\$12,154
Anchor rings	5	EACH	\$800	\$4,000
Stair tower (Down to base of dam)	1	LS	\$224,000	224,000
66-inch hydraulic operated butterfly valve	1	LS	\$66,000	\$66,000
		Sub total		\$410,000

Indian Creek Crossing				
Cast in place 10.5'W x 1.5'H x 16'L Reinforced Concrete Box Culvert	8	CY	\$2,770	\$22,160
Cast in place culvert transitions to 54" pipe	3	CY	\$2,770	\$8,310
Structural excavation	84	CY	\$46	\$3,864
1/2 CY bucket wheel mounted front end loader, min haul	97	CY	\$16	\$1,541
Hauling, 20 mile round trip, 0.4 loads/ hr (Add 15% for Expansion)	97	CY	\$27	\$2,580
Backfill and roller compaction operator walking	9	CY	\$44	\$394
Remove Gravel shoulder	6	SY	\$7	\$40
Replace Gravel shoulder	2	CY	\$48	\$97
Bedding, crushed rock, 1/2" to 3/4"	7	CY	\$49	\$345
Clearing	1	LS	\$500	\$500
Grouted Riprap Slope Protection, 3/8 to 1/4 CY Pieces, 18" Thick	28	SY	\$120	\$3,372
		Sub total		\$43,000

Various Small Culverts (3) Upstream of Chips Tie-In				
Cast in place 10.5'W x 1.5'H x 6'L Reinforced Concrete Box Culverts	9	CY	\$2,770	\$24,930
Cast in place culvert transitions to pipe	9	CY	\$2,770	\$24,930
Structural excavation	148	CY	\$46	\$6,808
1/2 CY bucket wheel mounted front end loader, min haul	170	CY	\$16	\$2,701
Hauling, 20 mile round trip, 0.4 loads/ hr (Add 15% for Expansion)	170	CY	\$27	\$4,522
Backfill and roller compaction operator walking	16	CY	\$44	\$700
Remove Gravel shoulder	11.5	SY	\$7	\$77
Replace Gravel shoulder	4	CY	\$48	\$193
Bedding, crushed rock, 1/2" to 3/4"	12	CY	\$49	\$591
Clearing	1	LS	\$1,500	\$1,500
Grouted Riprap Slope Protection, 3/8 to 1/4 CY Pieces, 18" Thick	47.8	SY	\$120	\$5,757
		Sub total		\$73,000

Chips Creek Crossing				
60" black steel pipe	130	LF	\$572	\$74,360
Concrete pier footing, piers, pier caps and abutments	19	CY	\$1,800	\$33,558
Pier and abutment excavation	18	CY	\$46	\$828
Structural steel	12	TONS	\$3,200	\$38,400
Structural steel, pier supports	3	TONS	\$4,300	\$12,900
Steel, anchor rings	5	EACH	\$800	\$4,000
Sediment and Erosion Control (Silt Fence)	130	LF	\$5	\$658
Clearing	1	LS	\$500	\$500
Excavation, truck mounted, 6-10' deep, 1 CY excavator, Hydraulic Jack hammer	43	CY	\$12	\$516
Backfill, 6" layers, roller compaction operator walking	18	CY	\$44	\$788
Grouted Riprap Slope Protection, 3/8 to 1/4 CY Pieces, 18" Thick	18	SY	\$120	\$2,168
Hauling, 20 mile round trip, 0.4 loads/ hr (Add 15% for Expansion)	38	CY	\$27	\$1,011
Remove Gravel shoulder	3	SY	\$7	\$20
Replace Gravel shoulder	1	CY	\$48	\$48
Bedding, crushed rock, 1/2" to 3/4"	17	CY	\$48	\$821
		Sub total		\$171,000

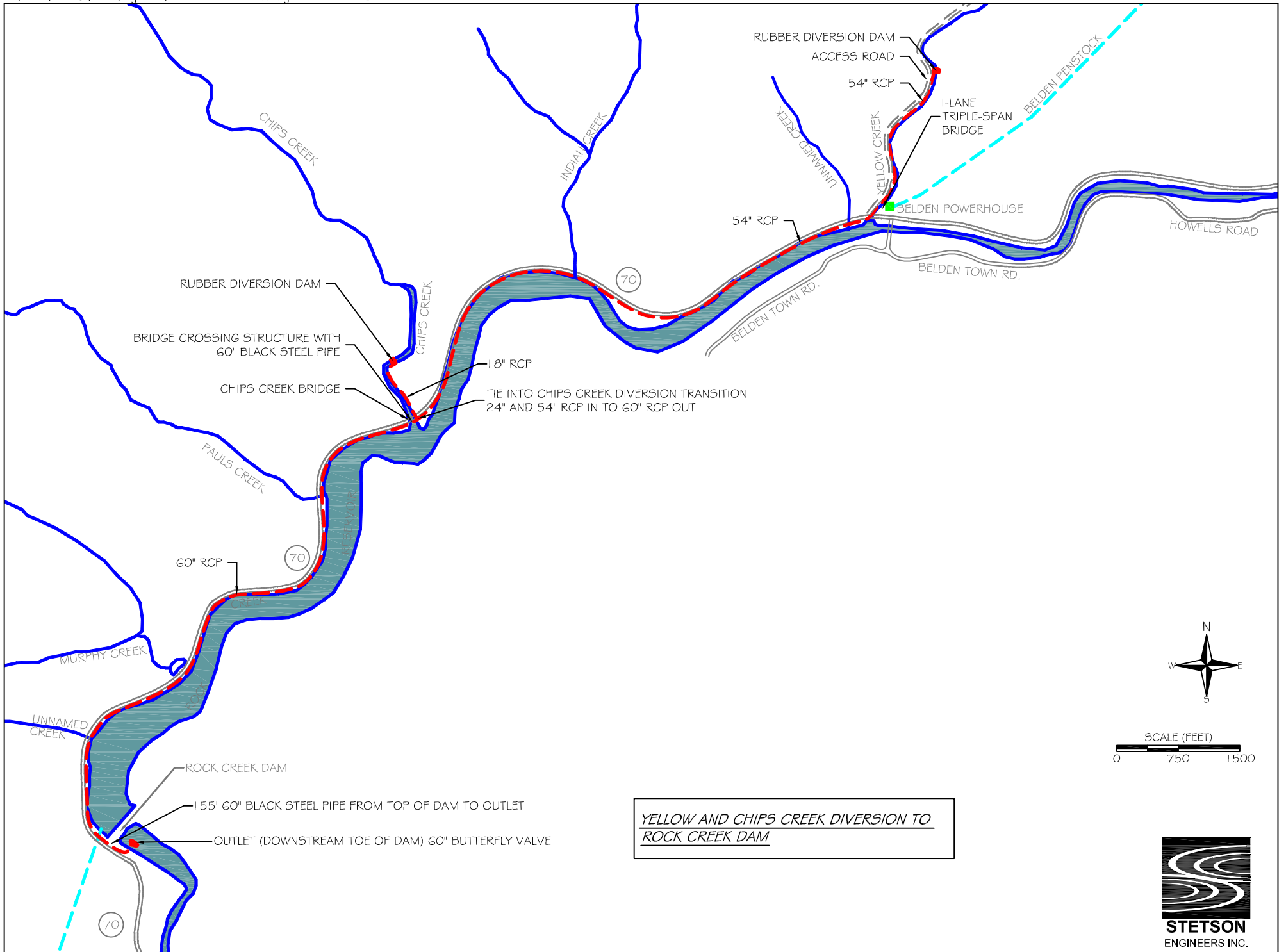
Paul's and Murphy's Creek Crossing (downstream of Chips Creek Tie-In)				
Cast in place 13'W x 1.5'H x 9'L Reinforced Concrete Box Culverts	11	CY	\$2,770	\$30,470
Cast in place culvert transitions to pipe	7	CY	\$2,770	\$19,390
Structural excavation	149	CY	\$46	\$6,854
1/2 CY bucket wheel mounted front end loader, min haul	171	CY	\$16	\$2,717
Hauling, 20 mile round trip, 0.4 loads/ hr (Add 15% for Expansion)	171	CY	\$27	\$4,549
Backfill and roller compaction operator walking	15	CY	\$44	\$657
Remove Gravel shoulder	9	SY	\$7	\$60
Replace Gravel shoulder	3	CY	\$48	\$145
Bedding, crushed rock, 1/2" to 3/4"	12	CY	\$48	\$579

Clearing	1	LS	\$1,000	\$1,000
Grouted Riprap Slope Protection, 3/8 to 1/4 CY Pieces, 18" Thick	39	SY	\$120	\$4,697
		Sub total		\$71,000

Various Small Culverts (2) Downstream of Chips Tie-In				
Cast in place 13'W x 1.5'H x 6'L Reinforced Concrete Box Culverts	7.4	CY	\$2,770	\$20,498
Cast in place culvert transitions to pipe	7.4	CY	\$2,770	\$20,498
Structural excavation	122	CY	\$46	\$5,612
1/2 CY bucket wheel mounted front end loader, min haul	140	CY	\$16	\$2,225
Hauling, 20 mile round trip, 0.4 loads/ hr (Add 15% for Expansion)	140	CY	\$27	\$3,724
Backfill and roller compaction operator walking	13	CY	\$44	\$569
Remove Gravel shoulder	8	SY	\$7	\$53
Replace Gravel shoulder	3	CY	\$48	\$145
Bedding, crushed rock, 1/2" to 3/4"	10	CY	\$49	\$493
Clearing	1	LS	\$1,500	\$1,500
Grouted Riprap Slope Protection, 3/8 to 1/4 CY Pieces, 18" Thick	32	SY	\$120	\$3,854
		Sub total		\$59,000

Mobilization / Demobilization				
Dozer, above 150 HP (3)	1	LS	\$3,600	\$3,600
Excavator, 1-1.5 CY Diesel Hyd. (2)	1	LS	\$9,600	\$9,600
Loader (2)	1	LS	\$2,400	\$2,400
Dump truck, 26 tons (10)	1	LS	\$6,000	\$6,000
25 ton truck mounted hydraulic crane (2)	1	LS	\$2,000	\$2,000
Crawler Type Drill, 4" (1)	1	LS	\$700	\$700
Grader, 30,000 lbs (2)	1	LS	\$2,400	\$2,400
Grout pumper (1)	1	LS	\$600	\$600
Water truck, 6000 gal (2)	1	LS	\$1,200	\$1,200
Wash & Screen (1)	1	LS	\$7,200	\$7,200
		Sub total		\$36,000

Total **\$15,652,000**



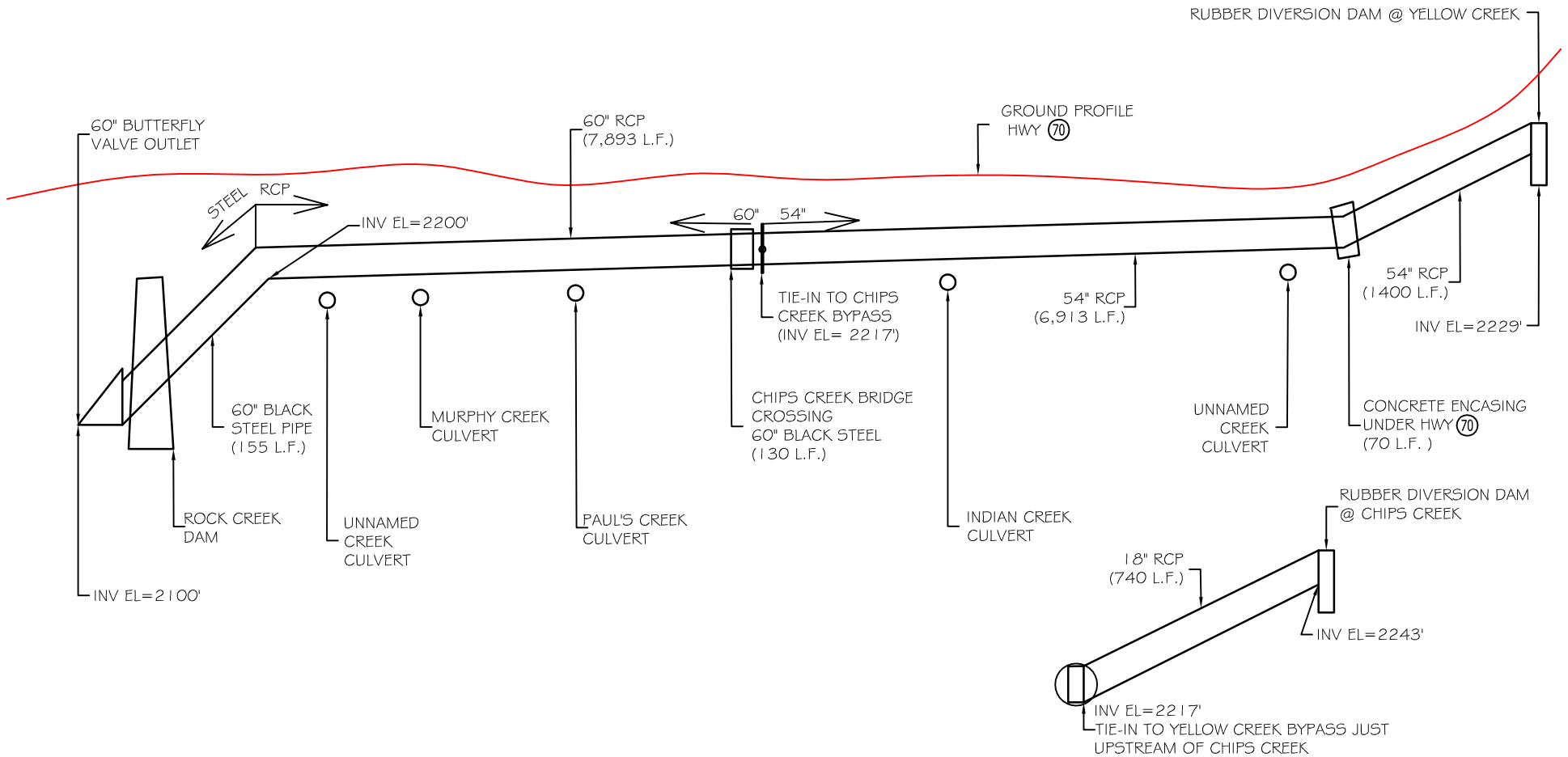
YELLOW AND CHIPS CREEK DIVERSION TO
ROCK CREEK DAM



SCALE (FEET)
0 750 1500



YELLOW AND CHIPS DIVERSION TO ROCK CREEK DAM



Measure Name: Divert Cool Lower Belden Reach and Yellow Creek Flows and Convey by Conduits to an Appropriate Plunging Location and Dredge a Submerged Channel in Rock Creek Reservoir

Applicable Alternative Category(s): 5a; additional measure for Rock Creek Reach

Description of Measure: Construct conduits to convey cool lower Belden Reach and Yellow Creek flows directly to a plunging location in Rock Creek Reservoir, bypassing the Belden PH discharge. The purpose of this measure is to avoid mixing cool lower Belden Reach and Yellow Creek flows with warmer discharges from the Belden PH during operating hours and minimize mixing with warmer ambient waters near the surface of Rock Creek Reservoir. Field observations in Rock Creek Reservoir during the 2006 NFFR special test conducted by PG&E indicate very little thermal stratification in Rock Creek Reservoir suggesting that dredging a channel along the bottom is required to facilitate the transport of cool water through the reservoir.

Description of Operations: This measure does not affect PH operations. At the lower Belden Reach dam, divert 140 cfs of cool lower Belden Reach flows and spill the remaining flow over the dam. The flow accretion along the Belden Reach, including inflows from East Branch NFFR, would maintain flows for aquatic habitat in the stream over the short distance between the diversion dam and the Yellow Creek/Belden PH confluence. At the Yellow Creek dam, divert 60 cfs of cool Yellow Creek flows and spill about 10 cfs to maintain flows for aquatic habitat in the stream over the short distance between the diversion dam and the NFFR/Belden PH confluence.

Detailed Description of Facilities Improvements and Design Criteria:

Construct two inflatable/deflatable rubber diversions dams; one on lower Belden Reach and another on Yellow Creek. On lower Belden Reach construct a 3-foot high rubber about 2,220 feet upstream of the Yellow Creek confluence and the Belden PH. On Yellow Creek, construct a 3-foot high rubber about 1,400 feet upstream of the Belden PH. Except during summer, the rubber dams remain in the deflated position.

The lower Belden Reach diversion dam directs 140 cfs through a 6' x 3' Reinforced Concrete Box (RCB) that is constructed in the NFFR channel. The Yellow Creek diversion dam directs 60 cfs through a 36-inch Reinforced Concrete Pipe (RCP) constructed along the bank. Near the NFFR/Yellow Creek confluence, the RCB and RCP join at a tie-in structure. The combined 200 cfs is conveyed about 7,100 feet through a 78-inch HDPE anchored to the bottom of the reservoir to a submerged discharge point near the confluence with Chips Creek. A submerged diffuser outlet is installed at the end of the pipeline to distribute the discharge in a larger cross sectional area for the purpose of reducing discharge velocity, turbulence, and mixing potential. Dredge a submerged channel a distance of about 7,000 feet along the bottom of the reservoir to a point near the low level outlet at Rock Creek Dam.

List of Figures:

- Plan view: Yellow Creek and Lower Belden Reach (NFFR) to Rock Creek Reservoir Plunging
- Profile: Yellow Creek / Belden Reach (NFFR) to Rock Creek Reservoir Plunging

Key Design or Construction Uncertainties Requiring Further Study:

- Dredging the reservoir bottom may require removing large boulders which could be difficult and costly.
- The dredged conveyance channel at the bottom of Rock Creek Reservoir will likely fill with sediment and will require repeated dredging.
- The effectiveness of cold water transport by a dredged channel in Rock Creek Reservoir requires further study.
- Setting a 78-inch HDPE along the bottom of Rock Creek Reservoir will be difficult and costly. Design and installation of an anchoring system adequate to withstand the potential forces on the pipe arising from flow momentum and land shifting requires further study.
- Installing a 6' x 3' reinforced concrete box culvert inside the channel along the north bank of the NFFR will be difficult and costly due to boulders and water in the channel.

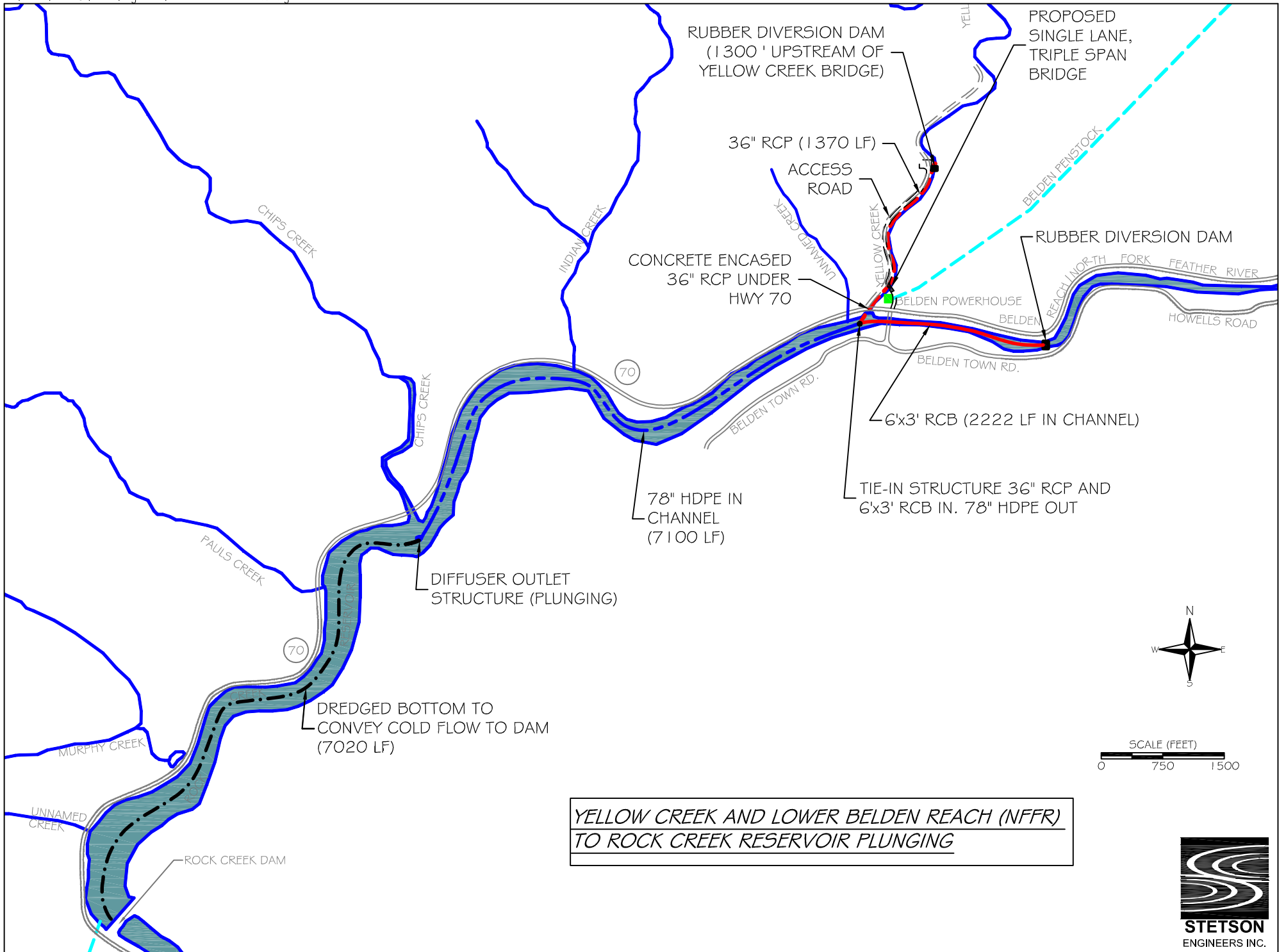
Discussion:

The location of the lower Belden Reach dam assumes that the measure to divert and convey warm East Branch NFFR flows to upper Rock Creek Reservoir is implemented. If it is not implemented, then the lower Belden Reach diversion dam needs to be located above the confluence of East Branch NFFR.

COST ESTIMATE FOR LOWER BELDEN REACH / YELLOW CREEK BYPASS TO PLUNGING				
ITEM	QUANTITY	UNIT	UNIT COST	COST
YELLOW CREEK RUBBER DAM AND INTAKE				
3' high and 71' wide inflatable rubber dam including: mobilization, site prep, foundation, turnout structure and all necessary materials and construction.	1	LS	\$1,510,000	\$1,510,000
		Sub Total Yellow Creek Dam		\$1,510,000
N FORK FEATHER RIVER RUBBER DAM AND INTAKE				
Mobilization				
Mobilization	1	LS	\$9,700	\$9,700
Site Clearing and Excavation				
Site Clearing	1	LS	\$1,200	\$1,200
Excavation Inside Channel	150	CY	\$24	\$3,532
Rubber Diversion Dam				
Concrete for Foundation	50	CY	\$1,200	\$60,000
Anchor Bolts	1	LS	\$1,200	\$1,200
Rubber Dam with Controls (3-foot diameter)	1	LS	\$259,000	\$259,000
Installation of Rubber Dam and Controls	1	LS	\$24,000	\$24,000
Installation Advisor for Rubber Dam and Controls	1	LS	\$12,000	\$12,000
Turnout Structure				
Excavation	300	CY	\$24	\$7,065
Concrete	40	CY	\$1,800	\$72,000
6'W X 3'H Canal Control Gate	1	LS	\$5,000	\$5,000
Handrail	1	LS	\$600	\$600
8-inch Diameter Vent Pipe, HDPE	1	LS	\$400	\$400
Access Hatch	1	LS	\$600	\$600
Precast Concrete Steps	1	LS	\$600	\$600
Trash Rack	1	LS	\$5,900	\$5,900
Cleanup and Demobilization				
Cleanup and Demobilization	1	LS	\$9,700	\$9,700
		Sub Total NF Feather River Dam		\$472,000
Access Road (710-feet along west bank of Yellow Creek)				

Sediment and Erosion Control (Silt Fence)	740	LF	\$5	\$3,744
Clearing (including Trees), Dozer 300 HP	1809	SY	\$6	\$10,819
Excavation, Road and Retaining Wall Footings, 1CY Truck Mounted Hydr.	547	CY	\$13	\$7,365
Hauling, 12 CY Dump Truck, 20-mile RT, 0.4 Loads / Hour	547	CY	\$38	\$21,033
Concrete for Retaining Wall Footings	30	CY	\$1,900	\$57,000
Steel Galv. Retaining Wall Posts, 8-Foot	11	EACH	\$84	\$923
Treated Wood for Retaining Wall	22080	BF	\$12	\$260,958
Fill, 1/2 to 3/4" Crushed Rock	532	CY	\$47	\$25,098
Fill, Road Surface Gravel	171	CY	\$36	\$6,209
24" CMP, corrugated 14 ga.	20	LF	\$50	\$1,009
Triple span, 1 lane bridge over Yellow Creek	1	LS	\$344,000	\$344,000
		Sub total access road		\$738,000
36" Pipe From Dam to Tie In at Confluence of Yellow Creek and NF Feather River				
36-inch Reinforced Concrete Pipe, Class 3	1370	LF	\$104	\$142,699
1/2 CY bucket wheel mounted front end loader, min haul	2566	CY	\$16	\$40,774
Hauling, 20 mile round trip, 0.4 loads/ hr (Add 15% for Expansion)	2566	CY	\$27	\$68,256
Compaction, walk behind vibrating plate, 18" wide, 6" lifts, 4 passes	1541	CY	\$3	\$4,669
Pipe bedding, crushed rock, 1/2" to 3/4"	1541	CY	\$48	\$74,399
Excavation, truck mounted, 6-10' deep, 1 CY excavator, Hydraulic Jack hammer	2231	CY	\$12	\$26,772
Precast Storm Drain Manhole, 4' I.D., 8' Deep	4	EACH	\$1,900	\$7,600
Concrete Encasement Under Hwy 70	43	CY	\$1,125	\$48,370
Grouted Riprap Slope Protection, 3/8 to 1/4 CY Pieces, 18" Thick	100	SY	\$120	\$12,044
Tie in Structure (36"RCP & 6'x3' RCB in / 78" HDPE out)	1	LS	\$6,000	\$6,000
Sawcut Asphalt, 4" Thick	122	LF	\$2	\$284
Pavement Removal, Bituminous Roads 4" to 6"	396	SF	\$8	\$3,073
Pavement Replacement Over Trench, 4" Thick	396	SF	\$35	\$13,963
Traffic Control	1	EACH	\$5,000	\$5,000
		Sub total 36" pipe		\$454,000
6' x 3' RCB From NF Feather River Dam to Tie In				
6' x 3' Reinforced Concrete Box	2222	LF	\$347	\$771,478
1/2 CY bucket wheel mounted front end loader, min haul	3408	CY	\$16	\$54,153
Hauling, 20 mile round trip, 0.4 loads/ hr (Add 15% for Expansion)	3408	CY	\$27	\$90,653
Excavator, Clamshell, 1/2 CY, wet plus addit. Equip	2963	CY	\$26	\$75,942
		Sub total 6' x 3' RCB		\$992,000
78-Inch HDPE From Tie In to Chips Creek (With Dredging to Dam)				

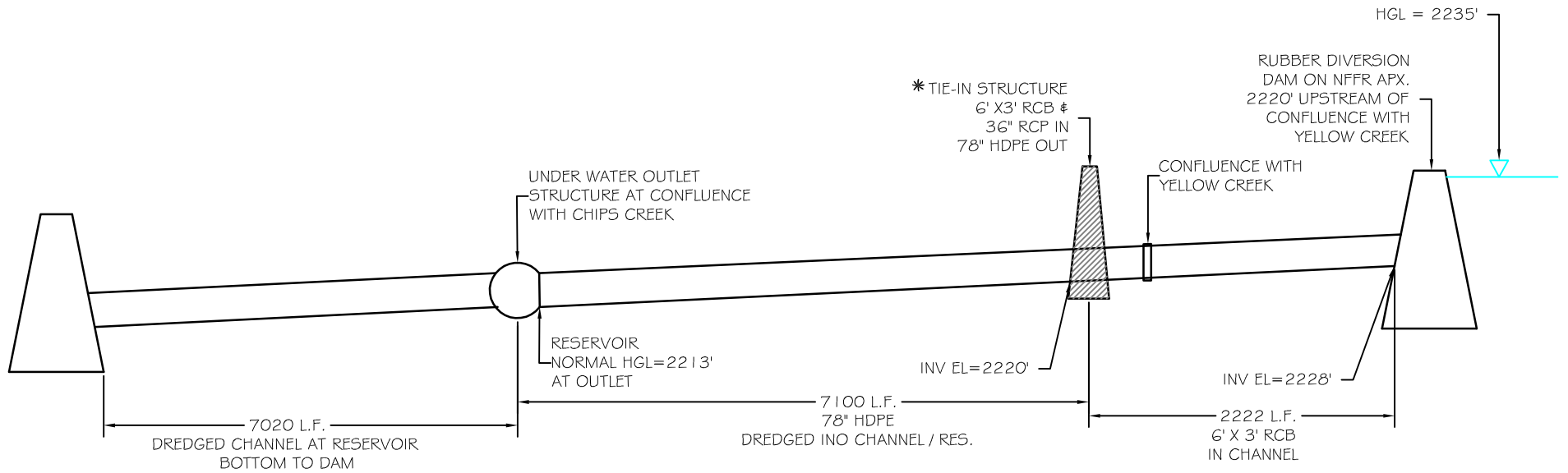
78-Inch HDPE From Tie In to Chips Creek	7100	LF	\$500	\$3,550,000
HDPE Pipe Placement, S-lay method with stinger, Mechanical Crane, barge mounted	1	LS	\$1,700,000	\$1,700,000
Mechanical Dredging, barge mounted, clamshell, hopper dumped	130256	CY	\$13	\$1,667,277
Cofferdam, 15-22' Deep, 2 lines of braces, 10" H max	117200	SF	\$39	\$4,570,800
Furnish and place topsoil, truck dumped, screened, 4" deep	39067	SY	\$4	\$151,580
Fine grading with seeding inc lime, fertilizer & seed w/ equip.	351600	SF	\$6	\$2,271,336
Concrete Outlet Diffuser Structure, Structure Pad and Rock Cover	1	LS	\$15,000	\$15,000
		Sub total 7' x 4' RCB		\$13,926,000
Mobilization				
Dozer, above 150 HP (3)	1	LS	\$3,600	\$3,600
Excavator, 1-1.5 CY Diesel Hyd. (2)	1	LS	\$9,600	\$9,600
Loader (2)	1	LS	\$2,400	\$2,400
Paver Mobilization	1	LS	\$1,200	\$1,200
Grout pumper (1)	1	LS	\$600	\$600
Mechanical Dredger, Crane and stinger, barge mounted and all equipment	1	LS	\$200,000	\$200,000
		Sub total Mob / Demob		\$217,000
			TOTAL	\$18,309,000



**YELLOW CREEK AND LOWER BELDEN REACH (NFFR)
TO ROCK CREEK RESERVOIR PLUNGING**



YELLOW CREEK / BELDEN REACH (NFFR) TO ROCK CREEK RESERVOIR PLUNGING



Measure Name: Divert Cool Lower Belden Reach Flows into a Pipeline to Discharge below Rock Creek Dam

Applicable Alternative Category(s): 6a

Description of Measure: Construct about 3-mile long pipeline to convey cool lower Belden Reach flows to discharge below Rock Creek Dam directly, bypassing Rock Creek Reservoir. The purpose of this measure is to avoid mixing cool lower Belden Reach flows with warmer discharges from the Belden PH during operational hours and avoid mixing with warmer ambient waters near the surface of Rock Creek Reservoir.

Description of Operations: This measure does not affect PH operations. Operate the diversion system to convey about 250 cfs through the pipeline and spill the remaining flow over the dam. The diversion rate is supplied by the increased release measure from Belden Dam. The flow accretion along the Belden Reach, including inflows from East Branch NFFR, would maintain flows for aquatic habitat in the short reach from the diversion dam to the Yellow Creek/Belden PH confluence.

Detailed Description of Facilities Improvements and Design Criteria:

Construct a 3-foot high inflatable/deflatable rubber diversion dam at the lower end of the Belden Reach just upstream of the Yellow Creek/Belden PH confluence. Except during summer, the rubber dam would remain in the deflated position. Construct an approximately 3 mile long pipeline to convey the cool Seneca Reach flows captured behind the dam to discharge below Rock Creek Dam.

The pipeline starts at the diversion dam and extends about 3 miles to below Rock Creek Dam. The first segment of the pipeline consists of about 500-feet of 66-inch reinforced concrete pipe (RCP) buried into the river bank and covered with riprap. Downstream of the Yellow Creek/Belden PH confluence, the pipe is buried along the shoulder of Highway 70 for approximately 14,650 feet along the north bank of the NFFR, crossing over various existing culverts to the top of Rock Creek Dam. The pipe then transitions to 66-inch Black Steel Pipe (BSP) and is bolted with rock anchors to the steep rock face on the southwest side of the dam for 155 feet to discharges through a manually operated butterfly valve into the Rock Creek Reach.

List of Figures:

- Plan view: Belden Reach (NFFR) to Rock Creek Dam
- Profile: Belden Reach (NFFR) Diversion to Rock Creek Dam
- Detail: Belden Reach (NFFR), Pipe Bridge Detail at Chips Creek
- Detail: Belden Reach (NFFR), Pipeline and Culvert Details

Key Design or Construction Uncertainties Requiring Further Study:

- Attaching a bridge crossing structure and steel pipeline to the existing Highway 70 bridge over Chips Creek could make the existing structure unstable and will require further study.

- Burying a 66-inch Reinforced Concrete Pipe near the channel along the north bank of the NFFR just upstream of the confluence with Yellow Creek will be difficult and costly due to boulders and water in the channel.
- Connecting 155 LF of 66-inch Black Steel Pipe to the steep rock face at the dam requires further study.

Discussion:

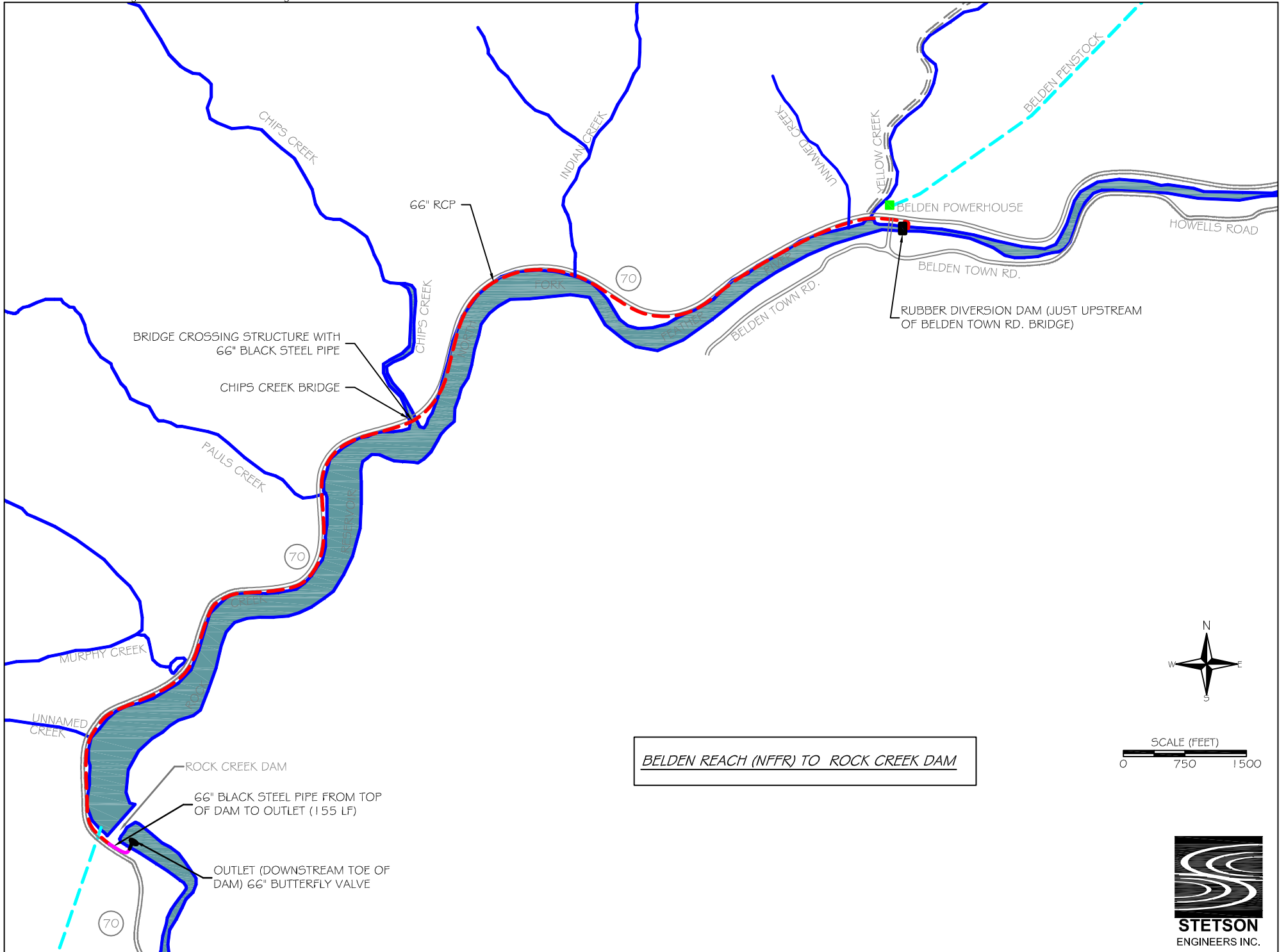
The location of the lower Belden Reach dam assumes that the measure to divert and convey warm East Branch NFFR flows into upper Rock Creek Reservoir is implemented. If it is not implemented, then the lower Belden Reach diversion dam needs to be located above the confluence of East Branch NFFR.

COST ESTIMATE FOR LOWER BELDEN REACH BYPASS TO ROCK CREEK DAM				
OPTION A 250 CFS				
ITEM	QUANTITY	UNIT	UNIT COST	COST
N FORK FEATHER RIVER RUBBER DAM AND INTAKE			(Rounded)	
3' high and 71' wide inflatable rubber dam including: mobilization, site prep, foundation, turnout structure and all necessary materials and construction.	1	LS	\$1,510,000	\$1,510,000
		Sub Total		\$1,510,000
66" Pipe From Dam to north bank of NF Feather River,				
66-inch Reinforced Concrete Pipe, Class 3	500	LF	309	\$154,500
Excavator, Clamshell, 1/2 CY, wet plus addit. Equip	1811	CY	26	\$46,416
1/2 CY bucket wheel mounted front end loader, min haul	2083	CY	16	\$33,099
Hauling, 20 mile round trip, 0.4 loads/ hr (Add 15% for Expansion)	2083	CY	27	\$55,408
Pipe bedding, crushed rock, 1/2" to 3/4"	723	CY	48	\$34,906
Backfill, 6" layers, roller compaction operator walking	472	CY	44	\$20,664
Grouted Riprap Slope Protection, 3/8 to 1/4 CY Pieces, 18" Thick	16	SY	120	\$1,927
Sediment and Erosion Control (Silt Fence)	500	LF	5	\$2,530
Precast Storm Drain Manhole, 6' I.D., 8' Deep	1	EACH	4,300	\$4,300
		Sub Total		\$354,000
66" Pipe from north bank of NF Feather River to SW side of Rock Creek Dam				
66-inch Reinforced Concrete Pipe, Class 3	14654	LF	309	\$4,528,086
Clearing, medium	2	ACRE	1,400	\$2,800
Backfill, 6" layers, roller compaction operator walking	13593	CY	44	\$595,102
Pipe bedding, crushed rock, 1/2" to 3/4"	20826	CY	48	\$1,005,479
Excavation, truck mounted, 6-10' deep, 1 CY excavator, Hydraulic Jack hammer	52108	CY	12	\$625,296
1/2 CY bucket wheel mounted front end loader, min haul	44292	CY	16	\$703,800

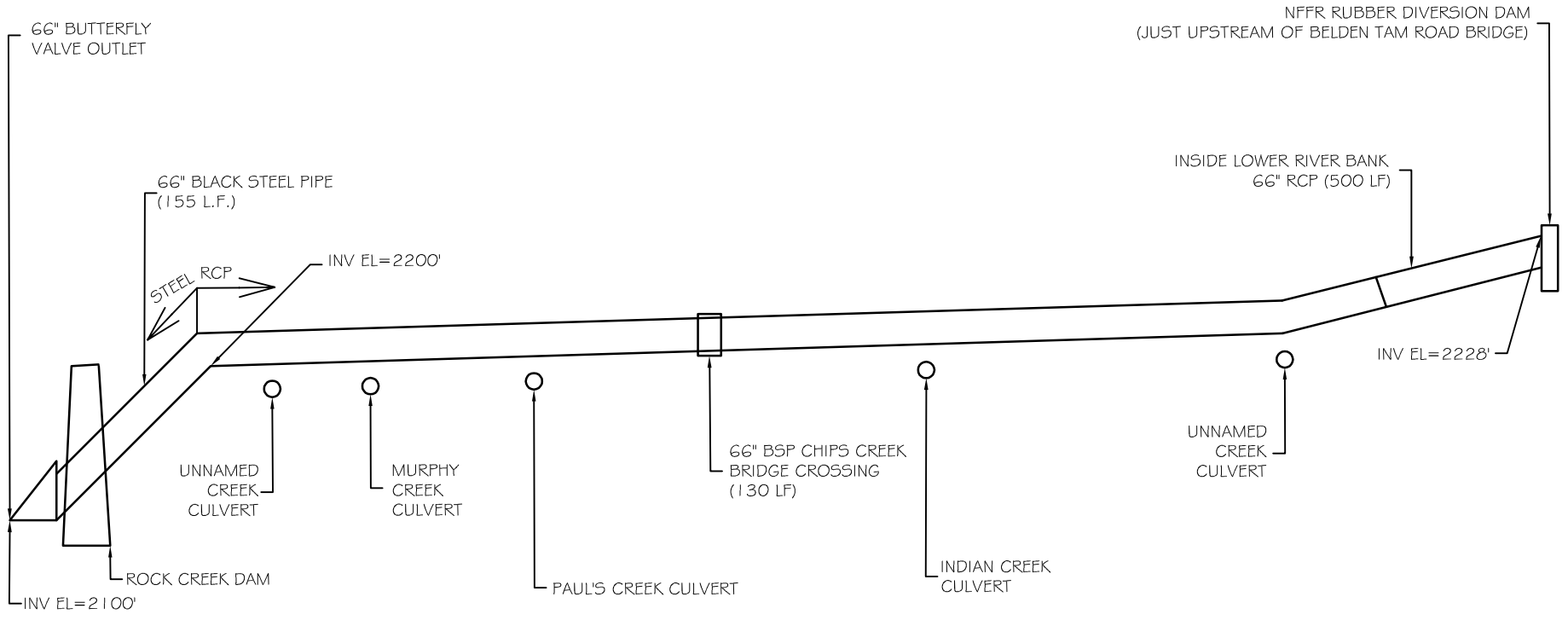
Hauling, 20 mile round trip, 0.4 loads/ hr (Add 15% for Expansion)	44292	CY	27	\$1,178,167
Precast Storm Drain Manhole, 6' I.D., 8' Deep	54	EACH	4,300	\$232,200
Grouted Riprap Slope Protection, 3/8 to 1/4 CY Pieces, 18" Thick	21318	SY	120	\$2,567,540
Remove Gravel shoulder	3969	SY	7	\$26,434
Sediment and Erosion Control (Silt Fence)	14393	LF	5	\$72,829
Remove and reset existing corrugated metal guard rail	12940	LF	35	\$449,277
Traffic control, signage	1	LS	30,000	\$30,000
Traffic control, 2 signals	1	LS	380,000	\$380,000
		Sub total		\$12,397,000
Chips Creek Crossing				
66" black steel pipe	130	LF	629	\$81,770
Concrete pier footing, piers, pier caps and abutments	19	CY	1,800	\$34,200
Pier and abutment excavation	18	CY	46	\$828
Structural steel	12	TONS	3,200	\$38,400
Structural steel, pier supports	3	TONS	4,300	\$12,900
Steel, anchor rings	5	EACH	800	\$4,000
Sediment and Erosion Control (Silt Fence)	130	LF	5	\$658
Clearing	1	LS	500	\$500
Excavation, truck mounted, 6-10' deep, 1 CY excavator, Hydraulic Jack hammer	43	CY	12	\$516
Backfill, 6" layers, roller compaction operator walking	11	CY	44	\$482
Grouted Riprap Slope Protection, 3/8 to 1/4 CY Pieces, 18" Thick	18	SY	120	\$2,168
1/2 CY bucket wheel mounted front end loader, min haul	38	CY	16	\$604
Hauling, 20 mile round trip, 0.4 loads/ hr (Add 15% for Expansion)	38	CY	27	\$1,011
Shoulder repair, crushed rock, 1/2" to 3/4"	1	CY	48	\$48
Bedding, crushed rock, 1/2" to 3/4"	17	CY	48	\$821
		Sub total		\$179,000
Paul's and Murphy's Creek Crossing				
Cast in place 15'W x 1.5'H x 9'L Reinforced Concrete Box Culverts	12	CY	2,800	\$33,600
Cast in place culvert transitions to pipe	11	CY	2,800	\$30,800
Structural excavation	53	CY	46	\$2,438
1/2 CY bucket wheel mounted front end loader, min haul	53	CY	16	\$842
Hauling, 20 mile round trip, 0.4 loads/ hr (Add 15% for Expansion)	61	CY	27	\$1,623
Backfill and roller compaction operator walking	17	CY	44	\$744
Shoulder repair, crushed rock, 1/2" to 3/4"	2	CY	48	\$97
Bedding, crushed rock, 1/2" to 3/4"	15	CY	48	\$724
Clearing	1	LS	1,000	\$1,000
Grouted Riprap Slope Protection, 3/8 to 1/4 CY Pieces, 18" Thick	18	SY	120	\$2,168
		Sub total		\$74,000

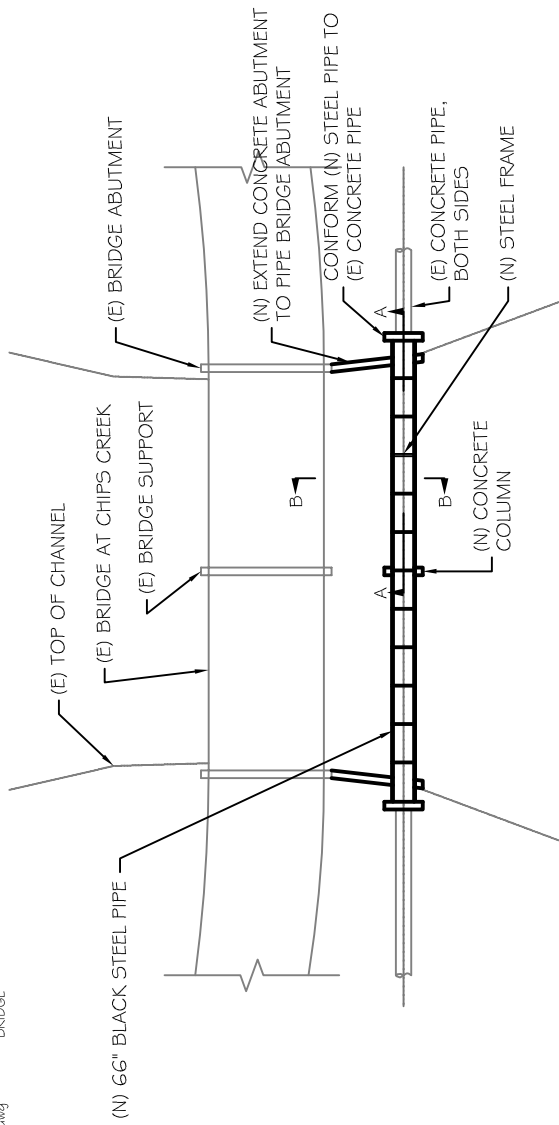
Indian Creek Crossing				
Cast in place 15'W x 1.5'H x 16'L Reinforced Concrete Box Culvert	10	CY	2,800	\$28,000
Cast in place culvert transitions to pipe	5	CY	2,800	\$14,000
Structural excavation	37	CY	46	\$1,702
1/2 CY bucket wheel mounted front end loader, min haul	43	CY	16	\$683
Hauling, 20 mile round trip, 0.4 loads/ hr (Add 15% for Expansion)	43	CY	27	\$1,144
Backfill and roller compaction operator walking	14	CY	44	\$613
Shoulder repair, crushed rock, 1/2" to 3/4"	1	CY	48	\$48
Bedding, crushed rock, 1/2" to 3/4"	13	CY	49	\$641
Clearing	1	LS	500	\$500
Grouted Riprap Slope Protection, 3/8 to 1/4 CY Pieces, 18" Thick	18	SY	120	\$2,168
		Sub total		\$50,000
Various Small Culverts (5)				
Cast in place 15'W x 1.5'H x 6'L Reinforced Concrete Box Culverts	20	CY	2,800	\$56,000
Cast in place culvert transitions to pipe	25	CY	2,800	\$70,000
Structural excavation	109	CY	46	\$5,014
1/2 CY bucket wheel mounted front end loader, min haul	125	CY	16	\$1,986
Hauling, 20 mile round trip, 0.4 loads/ hr (Add 15% for Expansion)	125	CY	27	\$3,325
Backfill and roller compaction operator walking	32	CY	44	\$1,401
Shoulder repair, crushed rock, 1/2" to 3/4"	5	CY	48	\$241
Bedding, crushed rock, 1/2" to 3/4"	27	CY	49	\$1,331
Clearing	1	LS	2,500	\$2,500
Grouted Riprap Slope Protection, 3/8 to 1/4 CY Pieces, 18" Thick	34	SY	120	\$4,095
		Sub total		\$146,000
Top of Rock Creek Dam to Outlet				
66-inch Reinforced Concrete Pipe, Class 3	139	LF	309	\$42,951
66" black steel pipe	155	LF	629	\$97,495
Backfill, 6" layers, roller compaction operator walking	131	CY	44	\$5,735
Pipe bedding, crushed rock, 1/2" to 3/4"	201	CY	48	\$9,704
Excavation, truck mounted, 6-10' deep, 1 CY excavator, Hydraulic Jack hammer	503	CY	12	\$6,036
Hauling, 20 mile round trip, 0.4 loads/ hr (Add 15% for Expansion)	460	CY	27	\$12,236
Rock excavation, drill and blast	11	CY	128	\$1,412
Drill rock anchor bolts	494	LF	29	\$14,143
Install rock anchor bolts	480	LF	25	\$12,154
Anchor rings	5	EACH	805	\$4,025
Stair tower (Down to base of dam)	1	LS	224,000	224,000
66-inch hydraulic operated butterfly valve	1	LS	66,000	\$66,000
		Sub total		\$496,000

Mobilization / Demobilization				
Dozer, above 150 HP (3)	1	LS	3,600	\$3,600
Excavator, 1-1.5 CY Diesel Hyd. (2)	1	LS	9,600	\$9,600
Loader (2)	1	LS	2,400	\$2,400
Dump truck, 26 tons (10)	1	LS	6,000	\$6,000
25 ton truck mounted hydraulic crane (2)	1	LS	2,000	\$2,000
Crawler Type Drill, 4" (1)	1	LS	700	\$700
Grader, 30,000 lbs (2)	1	LS	2,400	\$2,400
Grout pumper (1)	1	LS	600	\$600
Water truck, 6000 gal (2)	1	LS	1,200	\$1,200
Wash & Screen (1)	1	LS	7,000	\$7,000
		Sub total		\$36,000
			(Rounded)	\$15,242,000

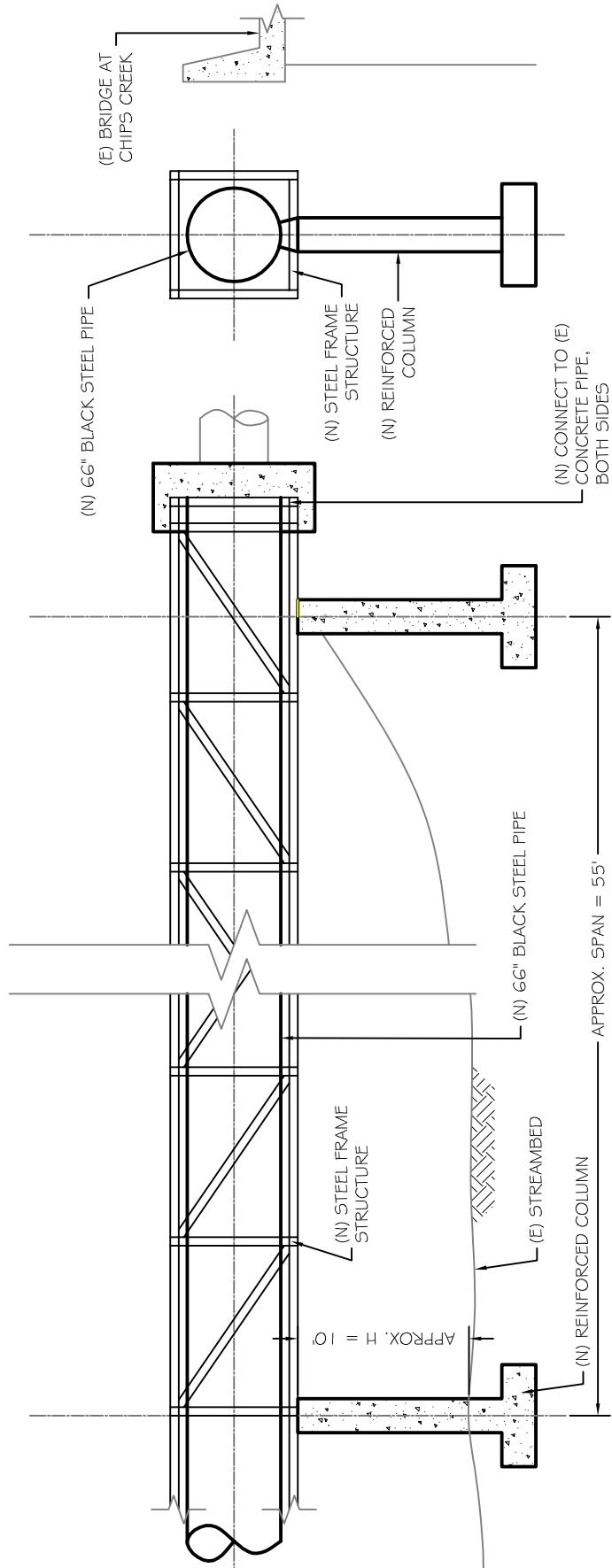


BELDEN REACH (NFFR) DIVERSION TO ROCK CREEK DAM





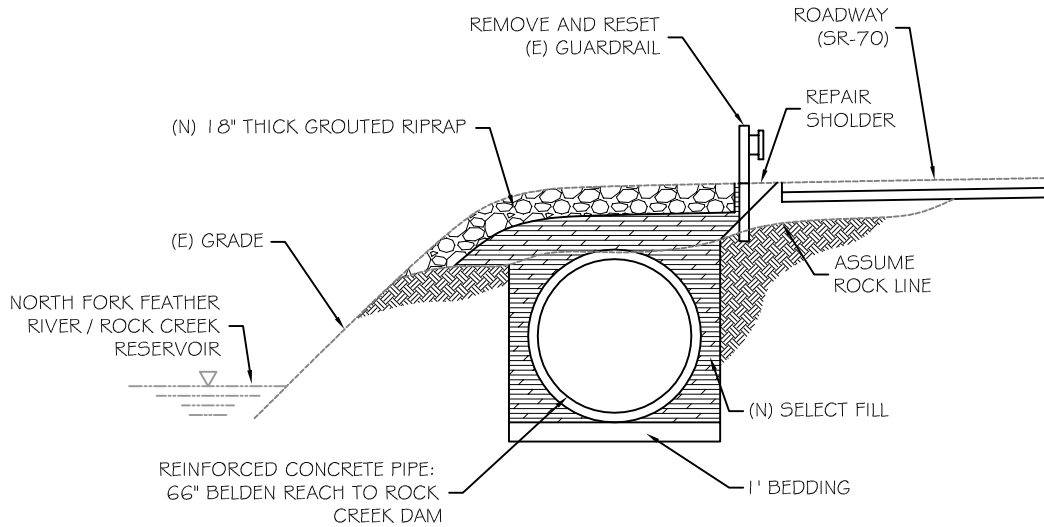
PLAN VIEW AT CHIPS CREEK



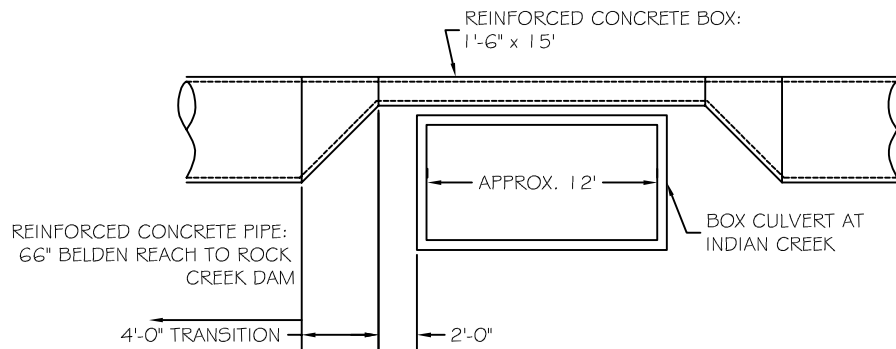
SECTION A-A

SECTION B-B

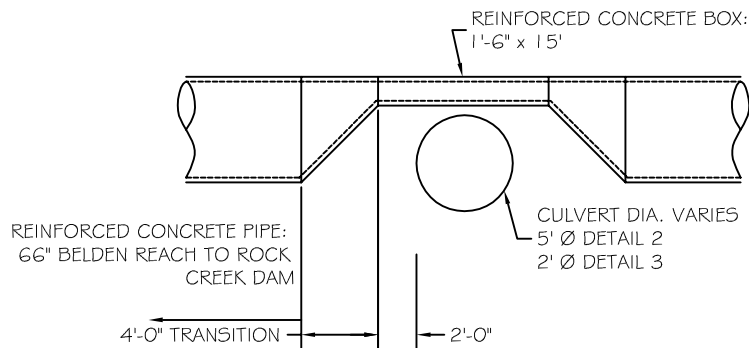
BELDEN REAH (NFR)
PIPE BRIDGE DETAIL AT CHIPS CREEK



TYPICAL PIPELINE SECTION



DETAIL 1



DETAIL 2 & 3

BELDEN REACH (NFFR)
PIPELINE AND CULVERT DETAILS

Measure Name: Convey Cool Bucks Creek PH Flows by a Submerged Pipeline to Discharge at an Appropriate Plunging Location and Dredge a Submerged Channel in Cresta Reservoir

Applicable Alternative Category(s): 4, 5; additional measure for Cresta Reach

Description of Measure: Construct a approximately 2.4-mile long pipeline to convey cool Buck Creek PH flows to an appropriate plunging location in Cresta Reservoir. The purpose of this measure is to avoid mixing with warmer ambient waters of Cresta Reservoir.

Description of Operations: This measure does not affect PH operations. According to PG&E's flow measurements in summer 2002-2004, Bucks Creek PH discharges during July and August ranged from 0 to 260 cfs. The cool water flow needed to reduce water temperatures below Cresta Dam is estimated at about 140 cfs. The design flow rate is 140 cfs, and Bucks Creek PH discharges exceeding 140 are released to the NFFR.

Detailed Description of Facilities Improvements and Design Criteria:

Construct a concrete regulating basin at the outlet of Bucks Creek PH. The regulating basin functions to regulate the powerhouse discharge between the NFFR and the proposed bypass pipeline. The regulating basin has an outlet consisting of a large gate valve connected to a 54-inch RCP bypass pipeline. The regulating basin also has a spillway to control the water level in the basin while releasing PH discharges exceeding the bypass flows to the NFFR.

The 54-inch RCP bypass pipeline extends from the regulating basin outlet structure to discharge below Cresta Dam. The first segment of the RCP extends about 10,050 ft and is buried under a new access road constructed along the south bank of the NFFR. In the second segment the pipeline transitions to 54-inch HDPE and enters Cresta Reservoir. The HDPE is set and anchored along the bottom of Cresta Reservoir for a distance of about 3,000 ft to an appropriate plunging location at the reservoir bottom. A submerged diffuser outlet is placed at the end of the pipeline to distribute the discharge in a larger cross sectional area for the purpose of reducing discharge velocity, turbulence, and mixing potential.

List of Figures:

- Plan view: Bucks Creek PH to Cresta Reservoir Plunging
- Profile: Bucks Creek PH to Cresta Reservoir Plunging Outlet
- Detail: Regulating Basin Detail at Bucks Creek PH

Key Design or Construction Uncertainties Requiring Further Study:

- Siting and designing the regulating basin above the floodplain of the NFFR to avoid flood damage requires further study.
- Setting a 54-inch HDPE along the bottom of Cresta Reservoir will be difficult and costly. Design and installation of an anchoring system adequate to withstand the

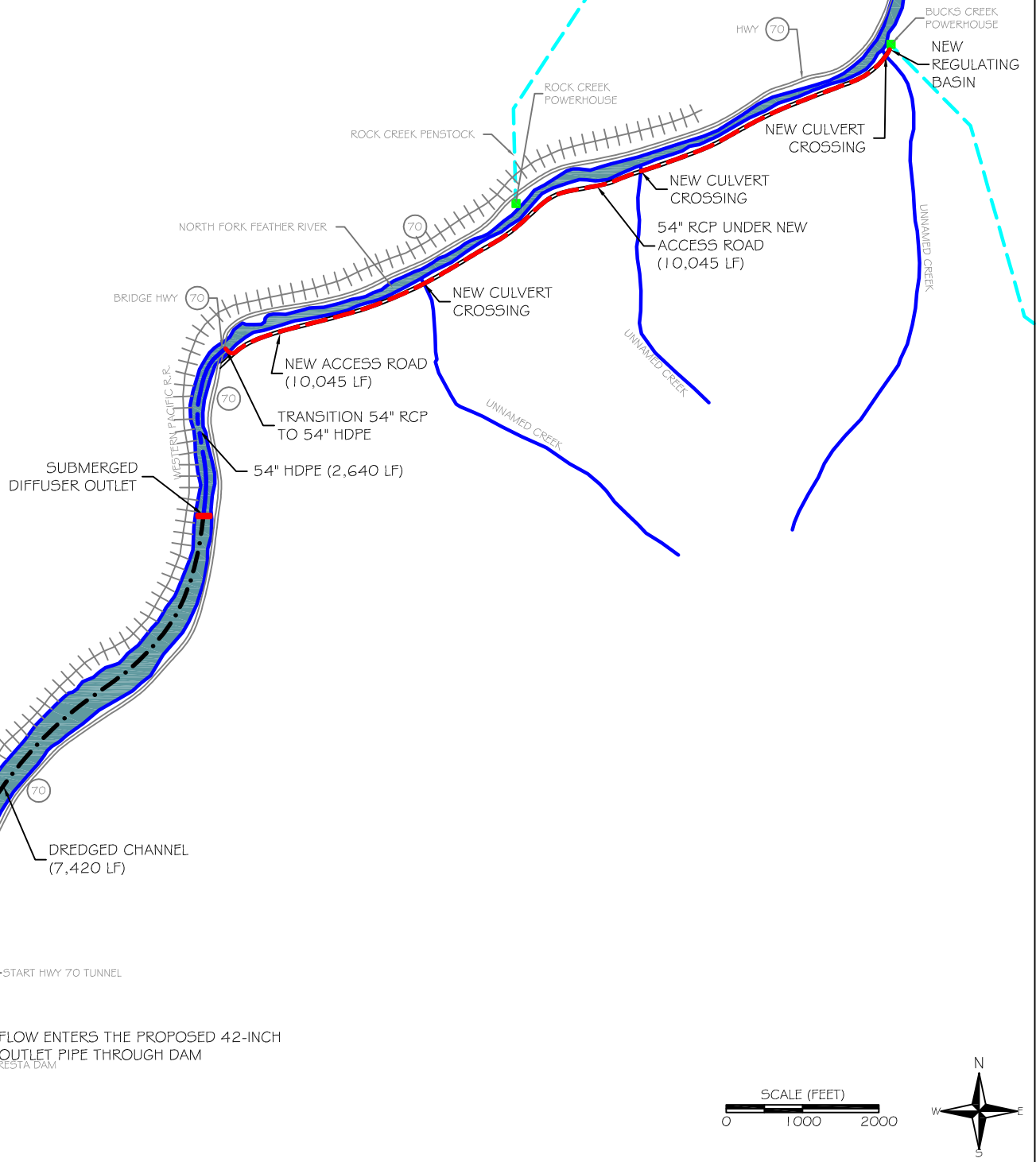
- potential forces on the pipe arising from flow momentum and land shifting requires further study.
- Microtunneling a 42-inch diameter outlet tunnel through the toe of Cresta Dam will be difficult, costly and time consuming due to the thickness of the concrete at the toe of the dam.
 - Dredging the reservoir bottom may require removing large boulders which could be difficult and costly.
 - The dredged conveyance channel at the bottom of Cresta Reservoir will likely fill with sediment and will require repeated dredging.
 - The effectiveness of cold water transport by a dredged channel in Cresta Reservoir requires further study.

Discussion:

The required cool water flow of 140 cfs from Bucks Creek PH was estimated based on the assumption that the mixing ratio of ambient warm water is 50%.

COST ESTIMATE FOR BUCKS CREEK PH TO CRESTA RESERVOIR PLUNGING				
ITEM	QUANTITY	UNIT	UNIT COST	COST
Access Road (10,045-feet along south bank of NFFR)				
Sediment and Erosion Control (Silt Fence)	10045	LF	\$5	\$50,817
Clearing (including Trees), Dozer 300 HP	24556	SY	\$6	\$146,862
Excavation, Road and Retaining Wall Footings, 1CY Truck Mounted Hydr.	7425	CY	\$13	\$99,976
Hauling, 12 CY Dump Truck, 20-mile RT, 0.4 Loads / Hour	7425	CY	\$38	\$285,507
Concrete for Retaining Wall Footings	407	CY	\$1,900	\$773,300
Concrete for Culvert Headwall Structures (6)	16	CY	\$1,900	\$30,400
Steel Galv. Retaining Wall Posts, 8-Foot	152	EACH	\$84	\$12,760
Treated Wood for Retaining Wall	299721	BF	\$12	\$3,542,332
Fill, 1/2 to 3/4" Crushed Rock	7222	CY	\$47	\$340,707
Fill, Road Surface Gravel	2321	CY	\$36	\$84,281
24" CMP, corrugated 14 ga.	60	LF	\$50	\$3,027
		Sub total access road		\$5,370,000
54" RCP from Bucks Creek Powerhouse to Cresta Reservoir / N Fork Feather River at Hwy 70 Bridge				
Cast in-Place Concrete Inlet / Outlet Structure at Powerhouse	101	CY	\$2,800	\$282,800
Transition structure, 6' x 3' RCB to 54" RCP	1	LS	\$7,000	\$7,000
6'W X 3'H Canal Control Gate	1	LS	\$6,000	\$6,000
54-inch Reinforced Concrete Pipe, Class 3	10045	LF	\$226	\$3,103,905
Clearing, medium	5	ACRE	\$1,400	\$7,000
Backfill, 6" layers, roller compaction operator walking	27003	CY	\$44	\$1,182,191
Pipe bedding, crushed rock, 1/2" to 3/4"	11154	CY	\$48	\$538,515
Excavation, truck mounted, 6-10' deep, 1 CY excavator, Hydraulic Jack hammer	41616	CY	\$12	\$499,392
1/2 CY bucket wheel mounted front end loader, min haul	21568	CY	\$16	\$342,716
Hauling, 20 mile round trip, 0.4 loads/ hr (Add 15% for Expansion)	21568	CY	\$27	\$573,709
Precast Storm Drain Manhole, 6' I.D., 8' Deep	12	EACH	\$4,300	\$51,600
Grouted Riprap Slope Protection, 3/8 to 1/4 CY Pieces, 18" Thick	33	SY	\$120	\$3,975
Sediment and Erosion Control (Silt Fence)	10045	LF	\$5	\$50,828
Traffic control, signage	1	LS	\$29,000	\$29,000
Traffic control, 2 signals	1	LS	\$100,000	\$100,000
		Sub total		\$6,779,000
54" HDPE from Hwy 70 Bridge to Tie-In at Toe of Dam				
54-inch HDPE	2640	LF	\$271	\$715,440

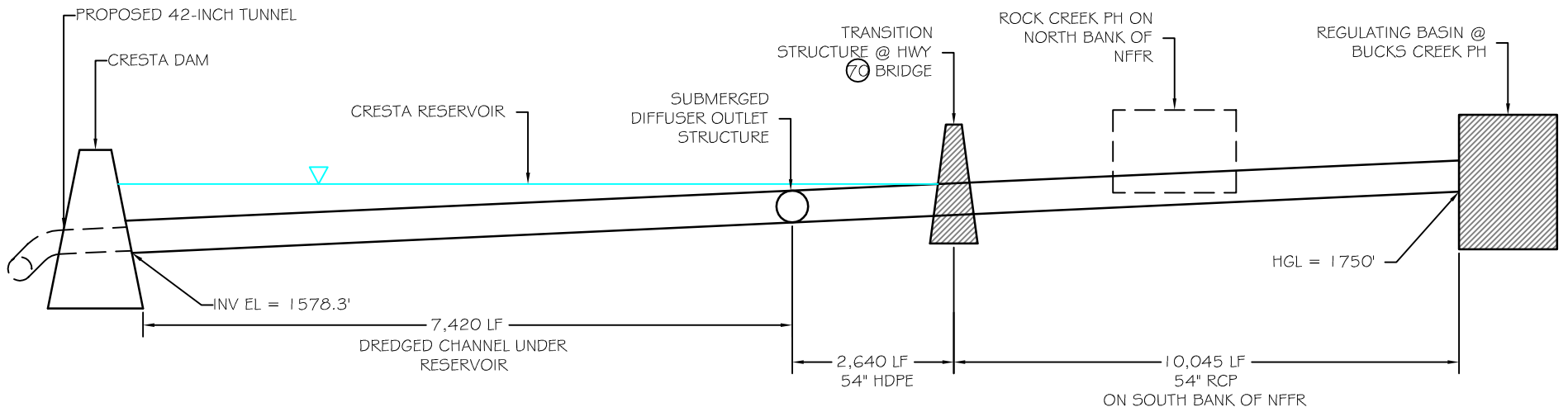
HDPE Pipe Placement, S-lay method with stinger, Mechanical Crane, barge mounted	1	LS	\$450,000	\$450,000
Mechanical Dredging, barge mounted, clamshell, hopper dumped	120720	CY	\$14	\$1,665,936
Cofferdam, 15-22' Deep, 2 lines of braces, 10" H max	108640	SF	\$39	\$4,236,960
Furnish and place topsoil, truck dumped, screened, 4" deep	36213	SY	\$4	\$140,506
Fine grading with seeding inc lime, fertilizer & seed w/ equip.	325920	SF	\$6	\$2,105,443
Underwater Diffuser Outlet	1	LS	\$15,000	\$15,000
Microtunneling 42-inch diameter hole in concrete dam under adverse conditions	70	LF	\$1,260	\$88,200
42" black steel water supply pipe w/ 1/2" walls	100	LF	\$426	\$42,600
Drill rock anchor bolts	100	LF	29	\$2,863
Install rock anchor bolts	100	LF	25	\$2,532
Anchor rings	4	EACH	805	\$3,220
42" butterfly valve (manually operated)	1	EACH	\$39,000	\$39,000
Diffuser Outlet Structure	1	LS	\$20,000	\$20,000
		Sub total		\$9,528,000
Mobilization				
Dozer, above 150 HP (3)	1	LS	\$3,600	\$3,600
Excavator, 1-1.5 CY Diesel Hyd. (2)	1	LS	\$9,600	\$9,600
Loader (2)	1	LS	\$2,400	\$2,400
Dump truck, 26 tons (10)	1	LS	\$6,000	\$6,000
25 ton truck mounted hydraulic crane (2)	1	LS	\$2,000	\$2,000
Grout pumper (1)	1	LS	\$600	\$600
Grader, 30,000 lbs (1)	1	LS	2,400	\$2,400
Crawler Type Drill, 4" (1)	1	LS	700	\$700
Water truck, 6000 gal (2)	1	LS	\$1,200	\$1,200
Wash & Screen (1)	1	LS	\$7,200	\$7,200
Mechanical Dredger, Crane and stinger, barge mounted and all equipment	1	LS	\$200,000	\$200,000
		Sub total Mob / Demob		\$236,000
			TOTAL	\$21,913,000



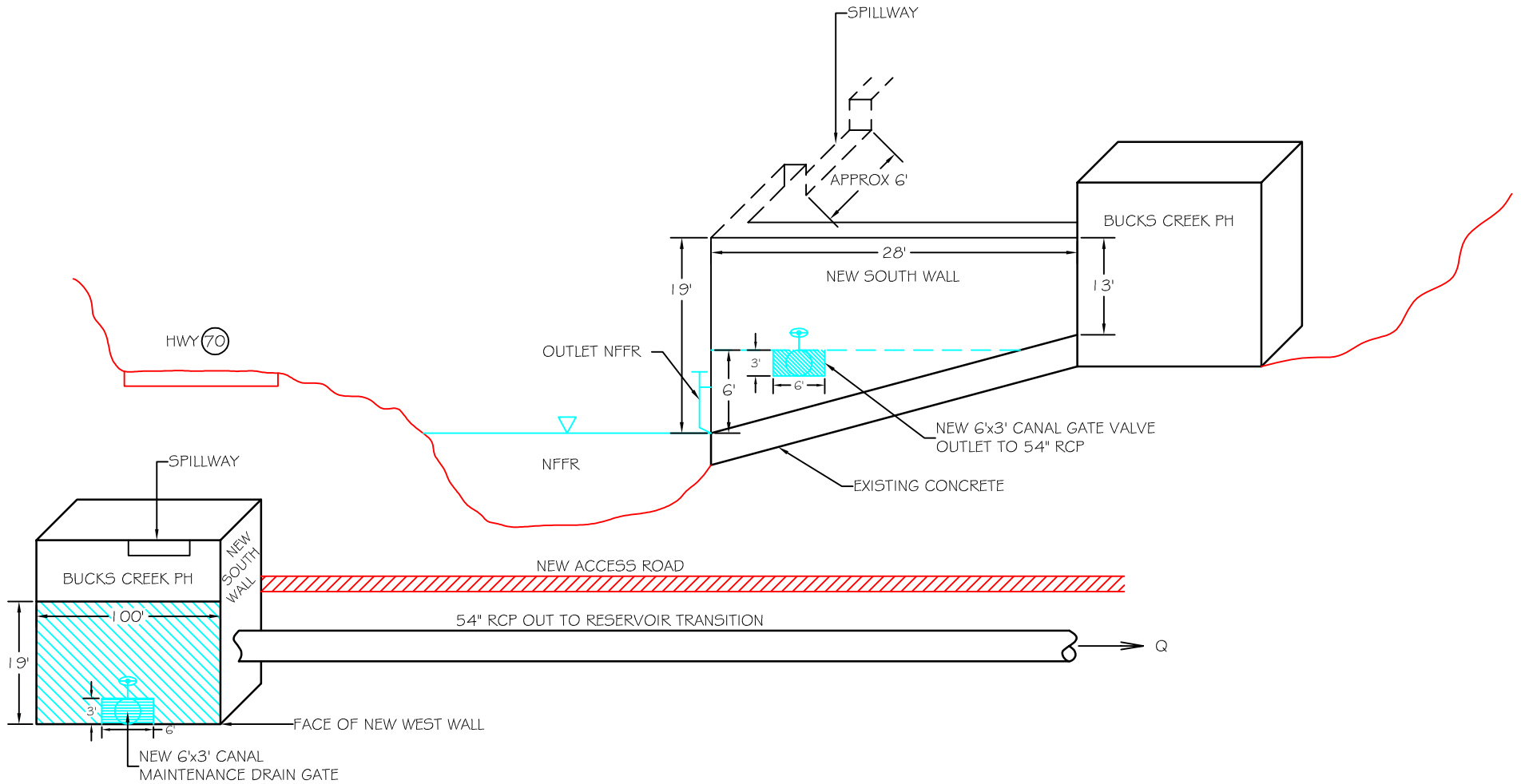
BUCKS CREEK PH TO CRESTA RESERVOIR PLUNGING



BUCKS CREEK PH TO CRESTA RESERVOIR PLUNGING OUTLET



REGULATING BASIN DETAIL AT BUCKS CREEK PH



Measure Name: Convey Cool Bucks Creek PH Flows by Pipeline to Discharge below Cresta Dam

Applicable Alternative Category(s): 4, 5; additional measure for Cresta Reach

Description of Measure: Construct about 4-mile long pipeline to convey cool Buck Creek PH flows to discharge below Cresta Dam, bypassing Cresta Reservoir. The purpose of this measure is to avoid mixing with warmer ambient waters of Cresta Reservoir.

Description of Operations: This measure does not affect PH operations. According to PG&E's flow measurements in summer 2002-2004, Bucks Creek PH discharges during July and August ranged from 0 to 260 cfs. The cool water flow needed to reduce water temperatures below Cresta Dam is estimated at about 95 cfs and 110 cfs for alternative categories 4 and 5 respectively. The design flow rate is 110 cfs, and Bucks Creek PH discharges exceeding 110 are released to the NFFR.

Detailed Description of Facilities Improvements and Design Criteria:

Construct a concrete regulating basin at the outlet of Bucks Creek PH. The regulating basin functions to regulate the powerhouse discharge between the NFFR and the proposed bypass pipeline. The regulating basin has an outlet consisting of a large gate valve connected to a 48-inch RCP bypass pipeline. The regulating basin also has a spillway to control the water level in the basin while releasing PH discharges exceeding the bypass flows to the NFFR.

The 48-inch RCP bypass pipeline extends from the regulating basin outlet structure to discharge below Cresta Dam. The first segment of the RCP extends about 10,050 ft and is buried under a new access road constructed along the south bank of the NFFR. In the second segment the pipeline transitions to 48-inch HDPE and enters Cresta Reservoir. The HDPE is set and anchored along the bottom of Cresta Reservoir for a distance of 10,050 ft to the dam. The HDPE connects to one of three submerged 92-inch sluice pipes that pass through and discharge below the dam.

List of Figures:

- Plan view: Bucks Creek PH to Cresta Dam
- Profile: Bucks Creek PH to Cresta Dam Outlet
- Detail: Regulating Basin Detail at Bucks Creek PH

Key Design or Construction Uncertainties Requiring Further Study:

- Siting and designing the regulating basin above the floodplain of the NFFR to avoid flood damages requires further study.
- Setting a 48-inch HDPE along the bottom of Cresta Reservoir will be difficult and costly. Design and installation of an anchoring system adequate to withstand the potential forces on the pipe arising from flow momentum and land shifting requires further study.

- Tying into the existing submerged 92-inch sluice pipe underwater at the toe of the dam will be difficult and costly due to underwater construction.

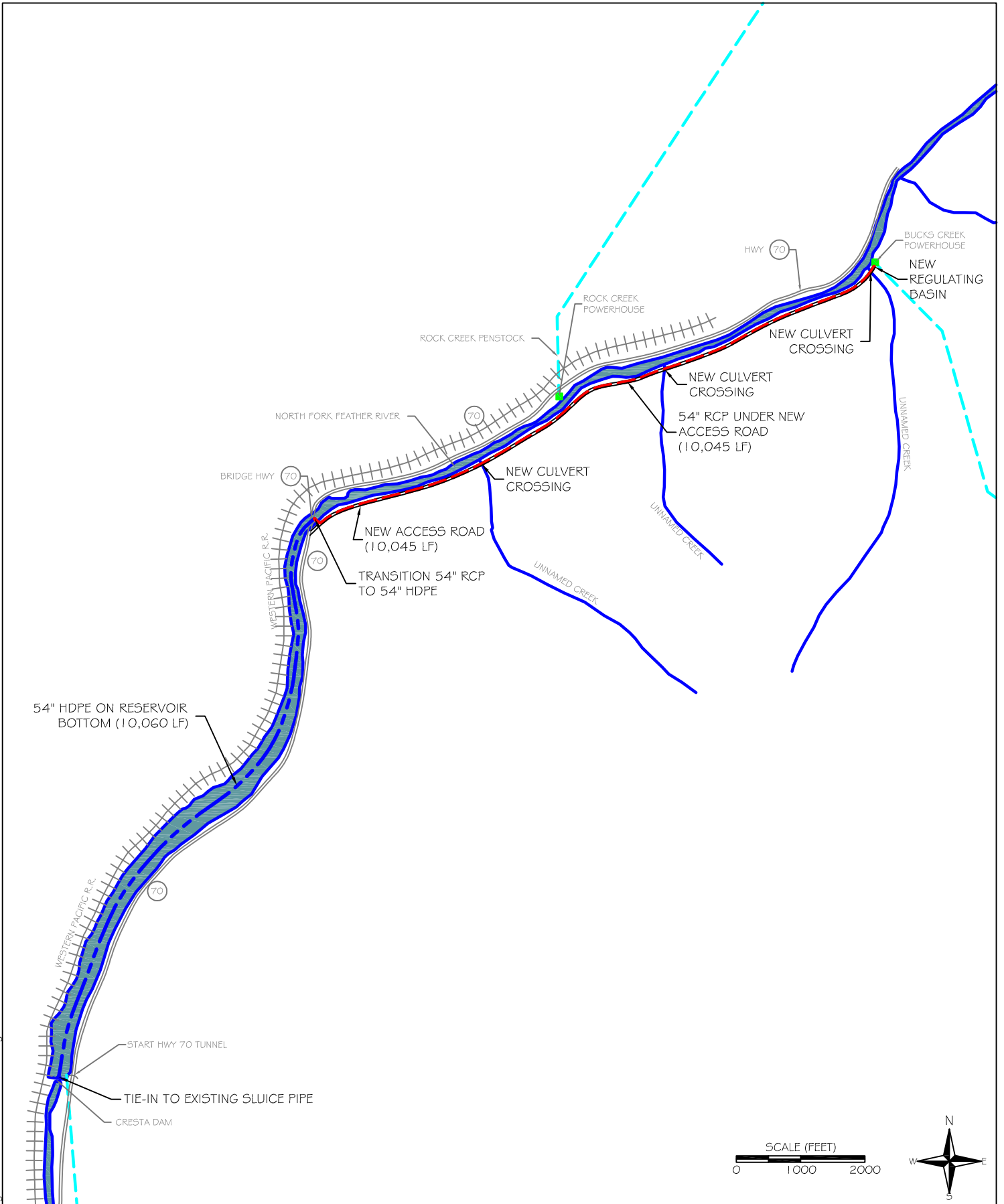
Discussion:

The design flow rate of 110 cfs is based on the estimated flow rate required to reduce water temperatures below Cresta Dam for alternative category 5. Alternative category 4 has lower flow rate requirement and thus requires smaller size of pipeline.

COST ESTIMATE FOR BUCKS CREEK PH TO CRESTA DAM				
ITEM	QUANTITY	UNIT	UNIT COST	COST

Access Road (10,045-feet along south bank of NFFR)				
Sediment and Erosion Control (Silt Fence)	10045	LF	\$5	\$50,817
Clearing (including Trees), Dozer 300 HP	24556	SY	\$6	\$146,862
Excavation, Road and Retaining Wall Footings, 1CY Truck Mounted Hydr.	7425	CY	\$13	\$99,976
Hauling, 12 CY Dump Truck, 20-mile RT, 0.4 Loads / Hour	7425	CY	\$38	\$285,507
Concrete for Retaining Wall Footings	407	CY	\$1,900	\$773,300
Concrete for Culvert Headwall Structures (6)	16	CY	\$1,900	\$30,400
Steel Galv. Retaining Wall Posts, 8-Foot	152	EACH	\$84	\$12,760
Treated Wood for Retaining Wall	299721	BF	\$12	\$3,542,332
Fill, 1/2 to 3/4" Crushed Rock	7222	CY	\$47	\$340,707
Fill, Road Surface Gravel	2321	CY	\$36	\$84,281
24" CMP, corrugated 14 ga.	60	LF	\$50	\$3,027
		Sub total access road		\$5,370,000
48" RCP from Bucks Creek Powerhouse to Cresta Reservoir / N Fork Feather River at Hwy 70 Bridge				
Cast in-Place Concrete Inlet / Outlet Structure at Powerhouse	101	CY	2,800	\$282,800
Transition structure, 6' x 3' RCB to 54" RCP	1	LS	\$7,000	\$7,000
6'W X 3'H Canal Control Gate	1	LS	\$6,000	\$6,000
48-inch Reinforced Concrete Pipe, Class 3	10045	LF	173	\$1,737,785
Clearing, medium	5	ACRE	1,400	\$7,000
Backfill, 6" layers, roller compaction operator walking	27003	CY	44	\$1,182,191
Pipe bedding, crushed rock, 1/2" to 3/4"	11154	CY	48	\$538,515
Excavation, truck mounted, 6-10' deep, 1 CY excavator, Hydraulic Jack hammer	41616	CY	12	\$499,392
1/2 CY bucket wheel mounted front end loader, min haul	21568	CY	16	\$342,716
Hauling, 20 mile round trip, 0.4 loads/ hr (Add 15% for Expansion)	21568	CY	27	\$573,709
Precast Storm Drain Manhole, 6' I.D., 8' Deep	12	EACH	4,300	\$51,600
Grouted Riprap Slope Protection, 3/8 to 1/4 CY	33	SY	120	\$3,975

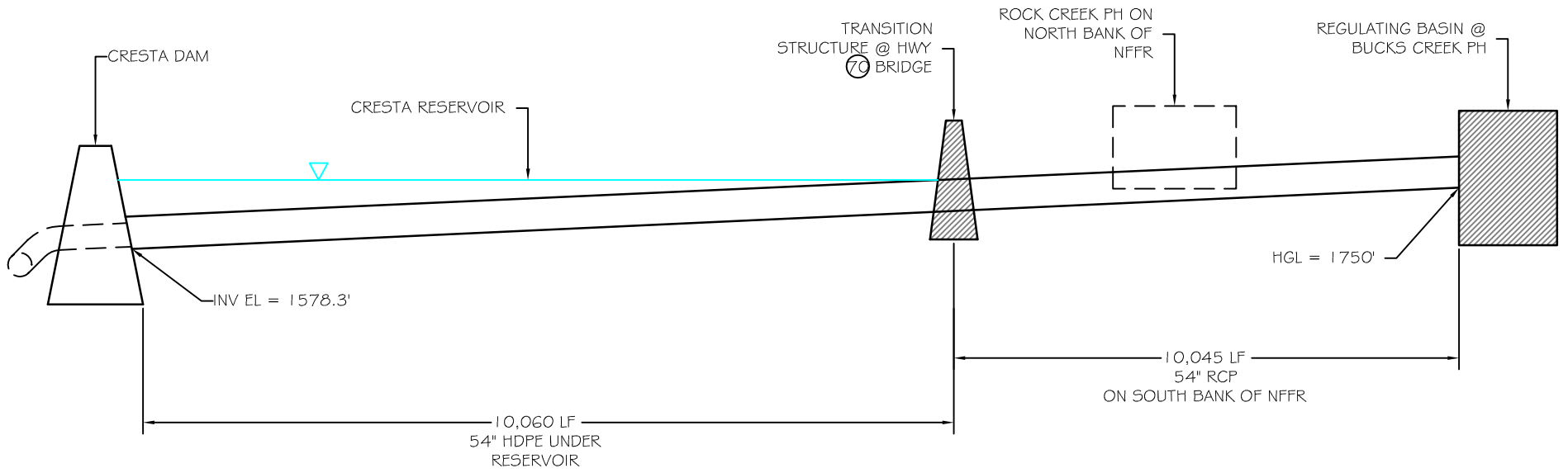
Pieces, 18" Thick				
Sediment and Erosion Control (Silt Fence)	10045	LF	5	\$50,828
Traffic control, signage	1	LS	29,000	\$29,000
Traffic control, 2 signals	1	LS	100,000	\$100,000
		Sub total		\$5,413,000
48" HDPE from Hwy 70 Bridge to Tie-In at Toe of Dam				
48-inch HDPE	10060	LF	214	\$2,152,840
HDPE Pipe Placement, S-lay method with stinger, Mechanical Crane, barge mounted	1	LS	1,300,000	\$1,300,000
Underwater pipe laying preparation of reservoir bottom	1	LS	\$3,087,000	\$3,087,000
Remove existing metal trash rack at toe of dam (apx 100' underwater)	1	LS	50,000	\$50,000
Concrete transition structure, 48" HDPE to 7.7'-dia sluice pipe	1	LS	12,000	\$12,000
Attach 48" HDPE to transition structure and sluice pipe (apx 100' underwater)	1	LS	150,000	\$150,000
		Sub total		\$6,752,000
Mobilization				
Dozer, above 150 HP (3)	1	LS	3,600	\$3,600
Excavator, 1-1.5 CY Diesel Hyd. (2)	1	LS	9,600	\$9,600
Loader (2)	1	LS	2,400	\$2,400
Dump truck, 26 tons (10)	1	LS	6,000	\$6,000
25 ton truck mounted hydraulic crane (2)	1	LS	2,000	\$2,000
Grout pumper (1)	1	LS	600	\$600
Water truck, 6000 gal (1)	1	LS	1,200	\$1,200
Grader, 30,000 lbs (1)	1	LS	2,400	\$2,400
Wash & Screen (1)	1	LS	7,200	\$7,200
Mechanical Dredger, Crane and stinger, barge mounted and all equipment	1	LS	200,000	\$200,000
		Sub total Mob / Demob		\$235,000
			TOTAL	\$17,770,000



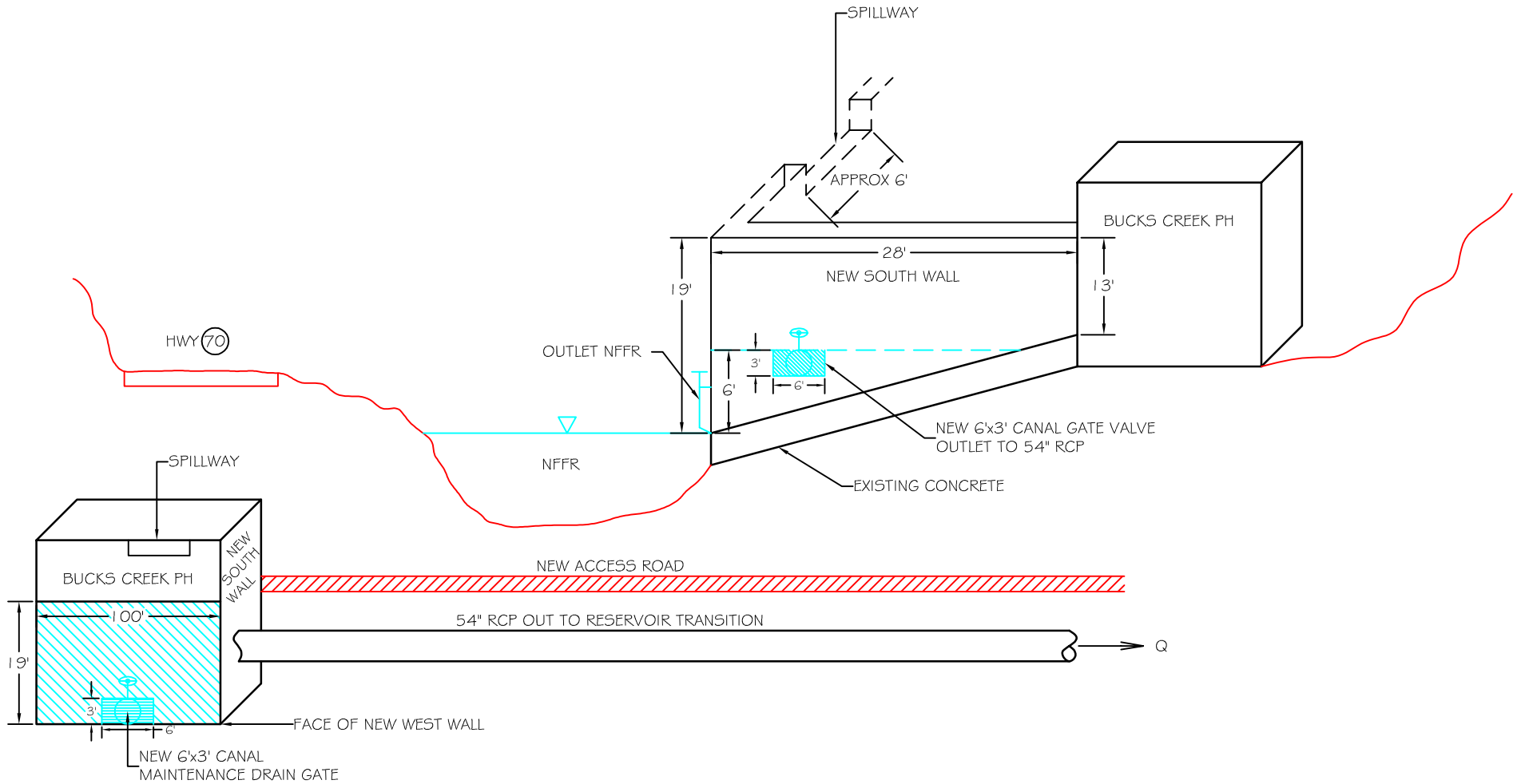
BUCKS CREEK PH TO CRESTA DAM



BUCKS CREEK PH TO CRESTA DAM OUTLET



REGULATING BASIN DETAIL AT BUCKS CREEK PH



Measure Name: Divert Cool Lower Rock Creek Reach Flows into a Pipeline to Discharge Below Cresta Dam

Applicable Alternative Category(s): 6a; additional measure for Cresta Reach

Description of Measure: Construct about 3-mile long pipeline to convey cool lower Rock Creek Reach flows to below Cresta Dam directly, bypassing Cresta Reservoir. The purpose of this measure is to avoid mixing cooler Rock Creek Reach flows with warmer ambient waters of Cresta Reservoir. This measure must be combined with the measure bypassing cold Seneca Reach flows around Belden Reservoir and the measure bypassing lower Belden Reach flows around Rock Creek Reservoir.

Description of Operations: This measure does not affect PH operations. Operate the diversion system to divert and convey about 250 cfs through the pipeline and spill the remaining flow over the diversion dam. The diversion rate is supplied by the increased release measure from Rock Creek Dam. The flow accretion from Bucks Creek and Bucks Creek PH inflows would maintain flows for aquatic habitat in the short reach from the diversion dam to the Rock Creek PH discharge.

Detailed Description of Facilities Improvements and Design Criteria:

Construct a 6-foot high rubber inflatable/deflatable rubber diversion dam on the NFFR about 150 feet upstream of the Rock Creek PH. Except during summer, the rubber dam remains in the deflated position.

The diversion dam directs 250 cfs through a 3-mile long pipeline to convey cool lower Rock Creek Reach flows to below Cresta Dam, bypassing Cresta Reservoir. The first segment consists of 66-inch RCP that extends about 150 ft to the Rock Creek PH. The pipe then transitions into a 66-inch Black Steel Pipe (BSP) which is connected to the face of Rock Creek PH and extends about 160 feet to the north bank of the NFFR just downstream of Rock Creek PH. The pipe material then transitions back into 66-inch RCP where it is buried along the shoulder of Highway 70 for approximately 4,155 feet. The pipe then enters Cresta Reservoir and where it transitions to 66-inch HDPE. The HDPE pipe is set and anchored to the reservoir bottom for the last 10,060 feet to Cresta Dam. The end of the 66-inch HDPE connects to one of the three existing submerged 92-inch sluice pipes (currently abandoned) at the toe of the dam which discharges below Cresta Dam.

List of Figures:

- Plan view: North Fork Feather River (NFFR), Lower Rock Creek Reach Bypass
- Profile: Lower Rock Creek Reach Bypass to Cresta Dam and Details

Key Design or Construction Uncertainties Requiring Further Study:

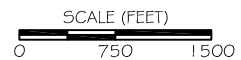
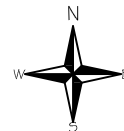
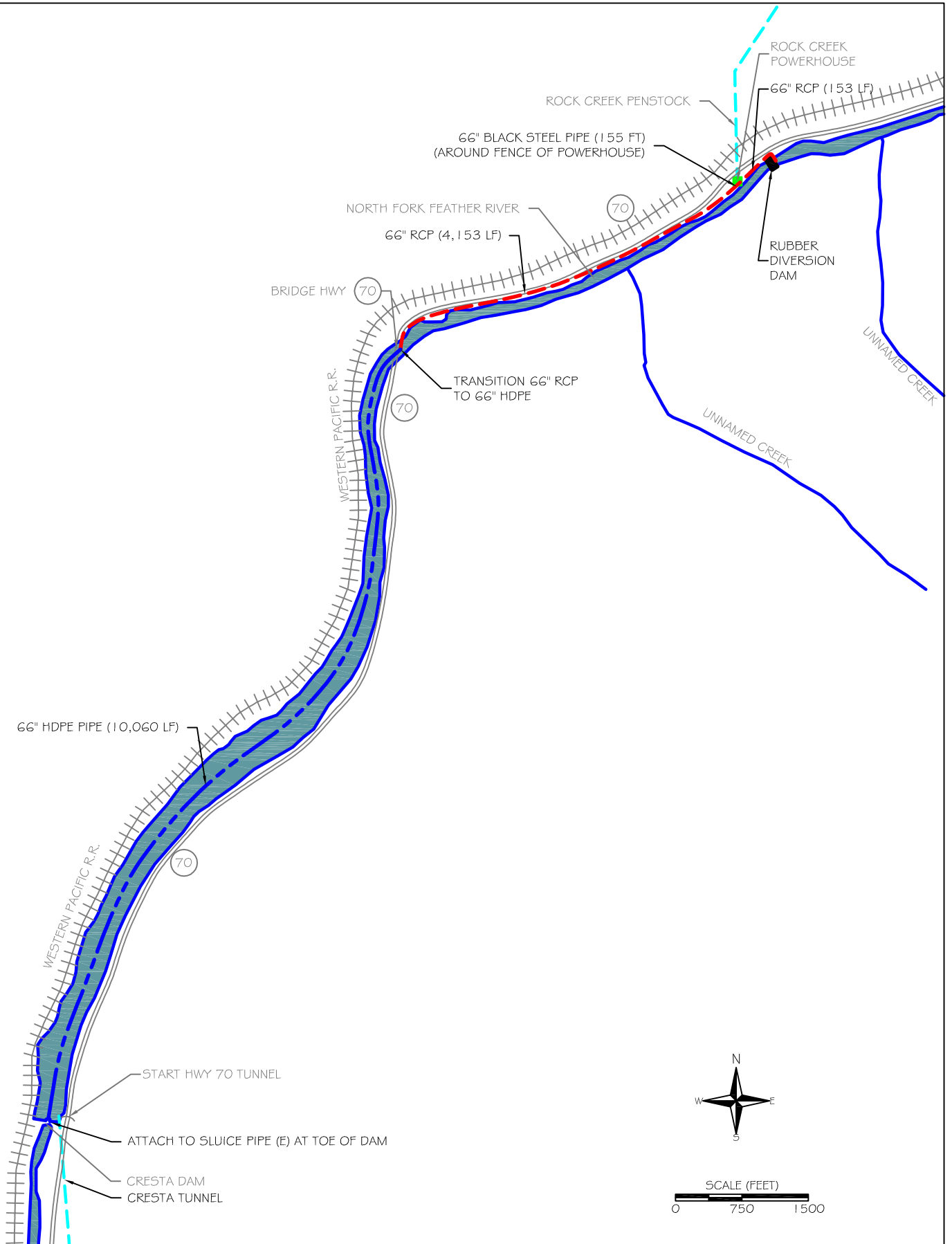
- Attaching to the existing 7'-8 3/8" I.D. sluice pipe underwater at the toe of Cresta Dam will be difficult and costly due to underwater construction.
- Connecting a 66-inch black steel pipe to the face of the powerhouse and anchoring it against the flow forces of the NFFR requires further study.

- Setting a 66-inch HDPE along the bottom of Cresta Reservoir will be difficult and costly. Design and installation of an anchoring system adequate to withstand the potential forces on the pipe arising from flow momentum and land shifting requires further study.

Discussion: None

COST ESTIMATE FOR LOWER ROCK CREEK REACH BYPASS TO CRESTA DAM				
ITEM	QUANTITY	UNIT	UNIT COST	COST
N FORK FEATHER RIVER RUBBER DAM AND INTAKE AT ROCK CREEK PH				
6' high and 78' wide inflatable rubber dam including: mobilization, site prep, foundation, turnout structure and all necessary materials and construction.	1	LS	\$3,320,000	\$3,320,000
		Sub Total NF Feather River Dam		\$3,320,000
66" RCP from Rubber Dam to Concrete Face of Rock Creek Powerhouse				
66-inch Reinforced Concrete Pipe, Class 3	153	LF	309	\$47,277
Grouted Riprap Slope Protection, 3/8 to 1/4 CY Pieces, 18" Thick	1374	SY	120	\$165,485
Excavator, Clamshell, 1/2 CY, wet plus addit. Equip	204	CY	26	\$5,229
Compaction, walk behind vibrating plate, 18" wide, 6" lifts, 4 passes	51	CY	3	\$155
Pipe bedding, crushed rock, 1/2" to 3/4"	51	CY	48	\$2,462
1/2 CY bucket wheel mounted front end loader, min haul	235	CY	16	\$3,734
Hauling, 20 mile round trip, 0.4 loads/ hr (Add 15% for Expansion)	235	CY	27	\$6,251
Sediment and Erosion Control (Silt Fence)	153	LF	5	\$774
		Sub total		\$231,000
66" Black Steel Pipe along Concrete Face of Rock Creek Powerhouse				
66" black steel pipe	155	LF	629	\$97,495
Drill concrete anchor bolts	155	LF	29	\$4,438
Install concrete anchor bolts	155	LF	25	\$3,925
Anchor rings	8	EACH	800	\$6,400
Precast Storm Drain Manhole, 6' I.D., 8' Deep	2	EACH	4,300	\$8,600
		Sub total		\$121,000
66" RCP from Concrete Face of Rock Creek Powerhouse to Cresta Reservoir / N Fork Feather River at Hwy 70 Bridge				
66-inch Reinforced Concrete Pipe, Class 3	4153	LF	309	\$1,283,277
Clearing, medium	1	ACRE	1,400	\$1,400
Backfill, 6" layers, roller compaction operator walking	3922	CY	44	\$171,705

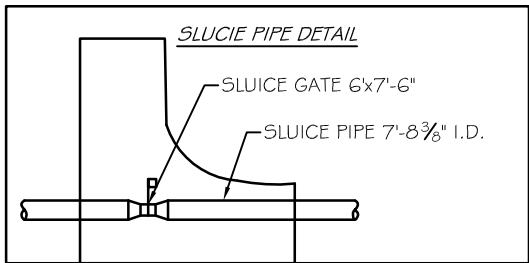
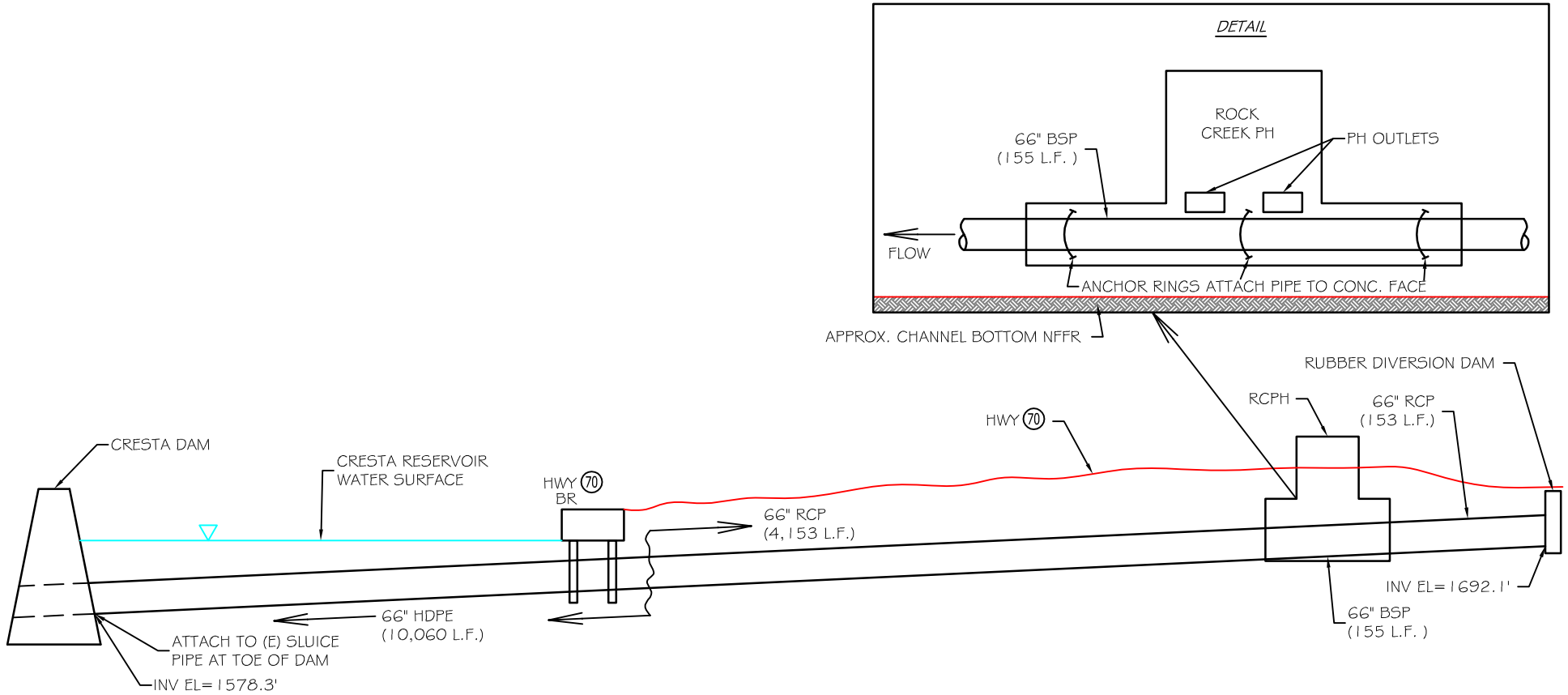
Pipe bedding, crushed rock, 1/2" to 3/4"	6009	CY	48	\$290,115
Excavation, truck mounted, 6-10' deep, 1 CY excavator, Hydraulic Jack hammer	15035	CY	12	\$180,420
1/2 CY bucket wheel mounted front end loader, min haul	12780	CY	16	\$203,074
Hauling, 20 mile round trip, 0.4 loads/ hr (Add 15% for Expansion)	12780	CY	27	\$339,948
Precast Storm Drain Manhole, 6' I.D., 8' Deep	14	EACH	4,300	\$60,200
Grouted Riprap Slope Protection, 3/8 to 1/4 CY Pieces, 18" Thick	6137	SY	120	\$739,140
Remove Gravel shoulder	1126	SY	7	\$7,499
Replace Gravel shoulder	375	CY	48	\$18,105
Shoulder Compaction, walk behind vibrating plate, 18" wide, 6" lifts, 4 passes	375	CY	3	\$1,136
Sediment and Erosion Control (Silt Fence)	4153	LF	5	\$21,014
Remove and reset existing corrugated metal guard rail	4153	LF	35	\$144,192
Traffic control, signage	1	LS	29,000	\$29,000
Traffic control, 2 signals	1	LS	382,000	\$382,000
		Sub total		\$3,872,000
66" HDPE from Hwy 70 Bridge to Tie-In at Toe of Dam				
66-inch HDPE	10060	LF	390	\$3,923,400
HDPE Pipe Placement, S-lay method with stinger, Mechanical Crane, barge mounted	1	LS	1,300,000	\$1,300,000
Underwater pipe laying preparation of reservoir bottom	1	LS	3,087,000	\$3,087,000
Remove existing metal trash rack at toe of dam (apx 100' underwater)	1	LS	50,000	\$50,000
Concrete transition structure, 66" HDPE to 7.7'-dia sluice pipe	1	LS	12,000	\$12,000
Attach 66" HDPE to transition structure and sluice pipe (apx 100' underwater)	1	LS	150,000	\$150,000
		Sub total		\$8,522,000
Mobilization				
Dozer, above 150 HP (3)	1	LS	3,600	\$3,600
Excavator, 1-1.5 CY Diesel Hyd. (2)	1	LS	9,600	\$9,600
Loader (2)	1	LS	2,400	\$2,400
Dump truck, 26 tons (10)	1	LS	6,000	\$6,000
25 ton truck mounted hydraulic crane (2)	1	LS	2,000	\$2,000
Crawler Type Drill, 4" (1)	1	LS	700	\$700
Grout pumper (1)	1	LS	600	\$600
Water truck, 6000 gal (2)	1	LS	1,200	\$1,200
Wash & Screen (1)	1	LS	7,200	\$7,200
Mechanical Dredger, Crane and stinger, barge mounted and all equipment	1	LS	200,000	\$200,000
		Sub total Mob / Demob		\$233,000
			TOTAL	\$16,299,000



***NORTH FORK FEATHER RIVER (NFFR)
LOWER ROCK CREEK REACH BYPASS TO CRESTA DAM***



LOWER ROCK CREEK REACH BYPASS TO CRESTA DAM



Measure Name: Convey Cool Water from Poe Adit to Poe Reach

Applicable Alternative Category(s): 2, 3, 4; additional measure for Poe Reach

Description of Measure: Construct an approximately 2/3-mile long pipeline to deliver cool water from the Poe Adit to the middle of Poe Reach. The purpose of this measure is to reduce water temperature in the lower Poe Reach.

Description of Operations: This measure does not affect PH operations. Convey 150 cfs from the Poe Adit to the middle of Poe Reach.

Detailed Description of Facilities Improvements and Design Criteria:

The delivery pipeline extends from the Poe Tunnel near Bardee's Bar, through the Poe Adit (the existing horizontal access tunnel leading to the Poe Tunnel) to the middle of the Poe Reach.

Flow is collected from the Poe Tunnel, which is an existing underground 17-foot diameter tunnel that delivers water from Poe Reservoir to Poe PH. The Poe Tunnel is accessed through the Poe Adit. The existing butterfly valve and tunnel access hole inside the adit is enlarged from 18 to 42-inches and attached to a 42-inch Black Steel Pipe (BSP) buried under the floor of the adit, carrying flow approximately 960 feet outside the adit. The 42-inch BSP is then jack and bored under the railroad tracks and buried under the existing gravel access road the remaining 2,000 feet to Poe Reach, discharging through a manually operated butterfly valve into the Poe Reach just downstream of Bardee's Bar Road Bridge.

Selected portions of the pipe alignment, design and costs were taken from the Black and Veatch Report (Prefeasibility Level Sizing and Cost Estimate Summary Memorandum, 2005).

List of Figures:

- Plan view: North Fork Feather River (NFFR) Poe Adit Pipeline.
- Profile: Poe Adit to NFFR at Poe Reach.

Key Design or Construction Uncertainties Requiring Further Study:

- It will be difficult and costly to microtunnel through Poe Tunnel from within Poe Adit due to tunneling through concrete in a confined space.
- The unstable spoils pile / hillside under proposed pipe alignment is dangerous requires further study of its stability.

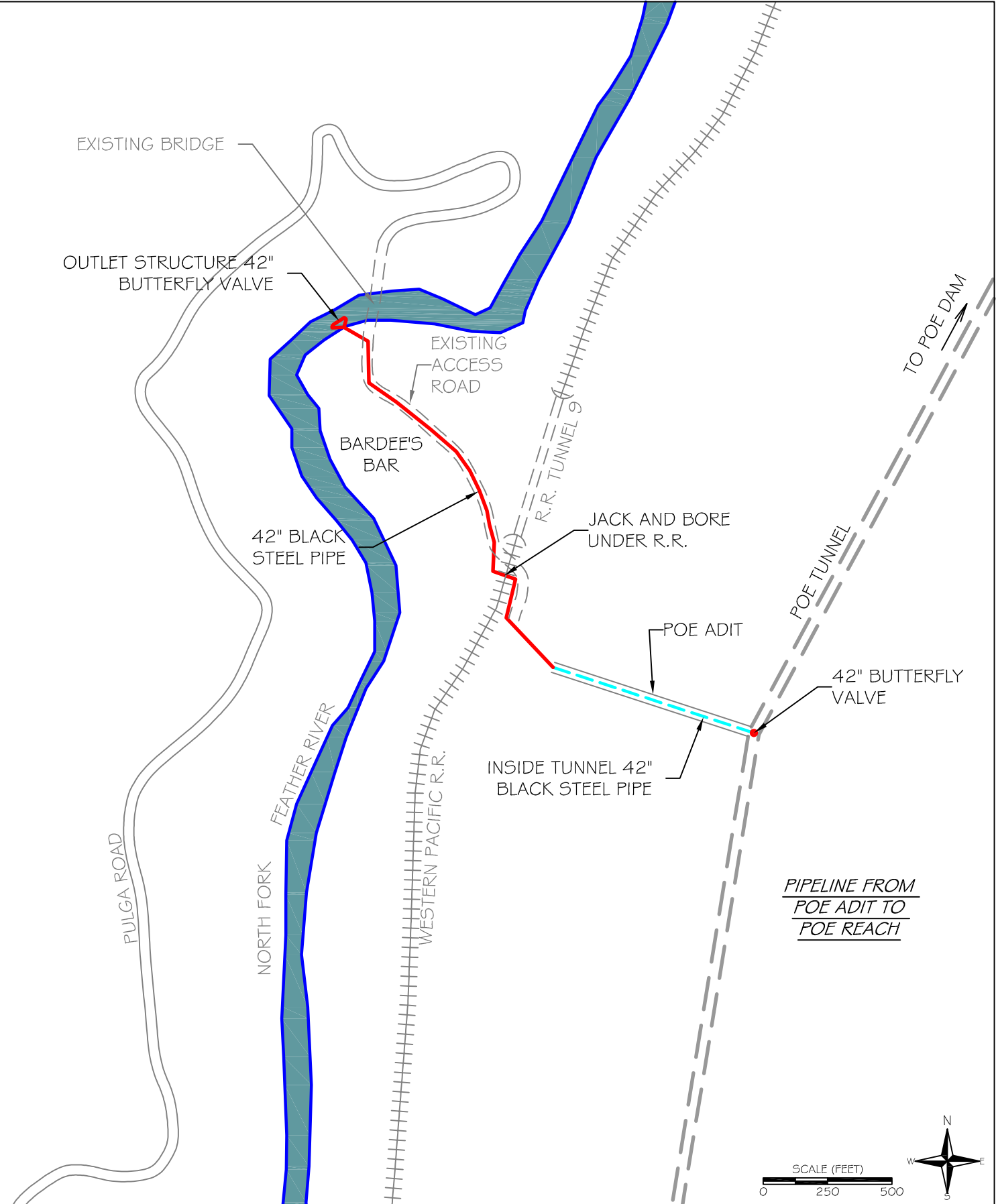
Discussion:

This design used diverted flow of 150 cfs from Poe Adit. However, the required discharge for each alternative category differs.

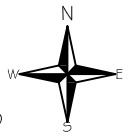
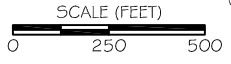
COST ESTIMATE FOR POE ADIT				
ITEM	QUANTITY	UNIT	UNIT COST	COST
INSIDE ADIT				
Microtunneling, increase existing 18" bore to 42" (cost for 24" to 48") hole in tunnel under adverse conditions	20	LF	\$1,260	\$25,200
Spoils handling inside tunnel				
1/2 CY bucket wheel mounted front end loader, min haul	3	CY	\$16	\$48
Hauling, 20 mile round trip, 0.4 loads/ hr	4	CY	\$27	\$106
Tunnel ventilation, duct, 48", 20ga., spun on site	1000	LF	\$21	\$21,480
Fan, 48" dia, 125 HP, inc. starter	1	EACH	\$29,000	\$29,000
Mob / demob of microtunneling equipment (maximum)	1	EACH	\$510,000	\$510,000
Pipe inside tunnel				
42" black steel water supply pipe w/ 1/2" walls	960	LF	\$426	\$408,960
Excavation by hand 2-6' deep in heavy soil inc tamping	1271	CY	\$94	\$118,839
Pipe bedding, crushed rock, 1/2" to 3/4"	929	CY	\$48	\$44,852
Compaction, walk behind vibrating plate, 18" wide, 6" lifts, 4 passes	929	CY	\$3	\$2,815
1/2 CY bucket wheel mounted front end loader, min haul	1271	CY	\$16	\$20,196
Hauling, 20 mile round trip, 0.4 loads/ hr	1271	CY	\$27	\$33,809
42" butterfly valve (manually operated)	1	EACH	\$39,000	\$39,000
90 degree 42" elbow	2	EACH	\$19,000	\$38,000
INSIDE ADIT				\$1,292,000

ITEM	QUANTITY	UNIT		COST
OUTSIDE ADIT				
Pipe outside gravel road				
42" black steel water supply pipe w/ 1/2" walls	402	LF	\$426	\$171,252
1/2 CY bucket wheel mounted front end loader, min haul	532	CY	\$16	\$8,453
Hauling, 20 mile round trip, 0.4 loads/ hr	532	CY	\$27	\$14,151
Compaction, walk behind vibrating plate, 18" wide, 6" lifts, 4 passes	389	CY	\$3	\$1,179
Pipe bedding, crushed rock, 1/2" to 3/4"	389	CY	\$48	\$18,781
Excavation, truck mounted, 6-10' deep, 1 CY excavator, Rock, drill & blast	532	CY	\$138	\$73,613
45 degree bend, 42"	3	EACH	\$10,000	\$30,000
90 degree 42" elbow	1	EACH	\$19,000	\$19,000
Pipe in gravel road				
42" black steel water supply pipe w/ 1/2" walls	1614	LF	\$426	\$687,564

Excavation, truck mounted, 6-10' deep, 1 CY excavator, Hydraulic Jack hammer	2137	CY	\$12	\$25,644
Pipe bedding, crushed rock, 1/2" to 3/4"	1562	CY	\$48	\$75,413
Compaction, walk behind vibrating plate, 18" wide, 6" lifts, 4 passes	1562	CY	\$3	\$4,733
1/2 CY bucket wheel mounted front end loader, min haul	2137	CY	\$16	\$33,957
Hauling, 20 mile round trip, 0.4 loads/ hr	2137	CY	\$27	\$56,844
22.5 degree bend, 42"	1	EACH	\$10,000	\$10,000
45 degree bend, 42"	4	EACH	\$10,000	\$40,000
90 degree 42" elbow	1	EACH	\$19,000	\$19,000
Resurface gravel road, 12' wide and apx 1614' long	19368	SF	\$2	\$37,380
Under Railroad				
42" black steel water supply pipe w/ 1/2" walls	33	LF	\$426	\$14,058
Horizontal boring, railroad work, 42" dia.	33	LF	\$580	\$19,140
Jacking pits inc. mob. / demob., maximum	1	EACH	\$22,000	\$22,000
1/2 CY bucket wheel mounted front end loader, min haul	29	CY	\$16	\$461
Hauling, 20 mile round trip, 0.4 loads/ hr	29	CY	\$27	\$771
Pipe bedding, crushed rock, 1/2" to 3/4"	17	CY	\$48	\$821
Outlet				
Concrete Outlet Structure	1	LS	\$30,000	\$30,000
42" butterfly valve (manually operated)	1	EACH	\$40,000	\$40,000
All sections				
Site clean up & repairs	1	EACH	\$172,000	\$172,000
Signage & traffic control	1	EACH	\$34,000	\$34,000
Silt fence	4660	LF	\$5	\$21,483
Site Demolition Work	1	EACH	\$2,900	\$2,900
General Equipment Mobilization	1	EACH	\$21,000	\$21,000
OUTSIDE ADIT				\$1,706,000
COMPLETE BYPASS			(Rounded)	\$2,998,000



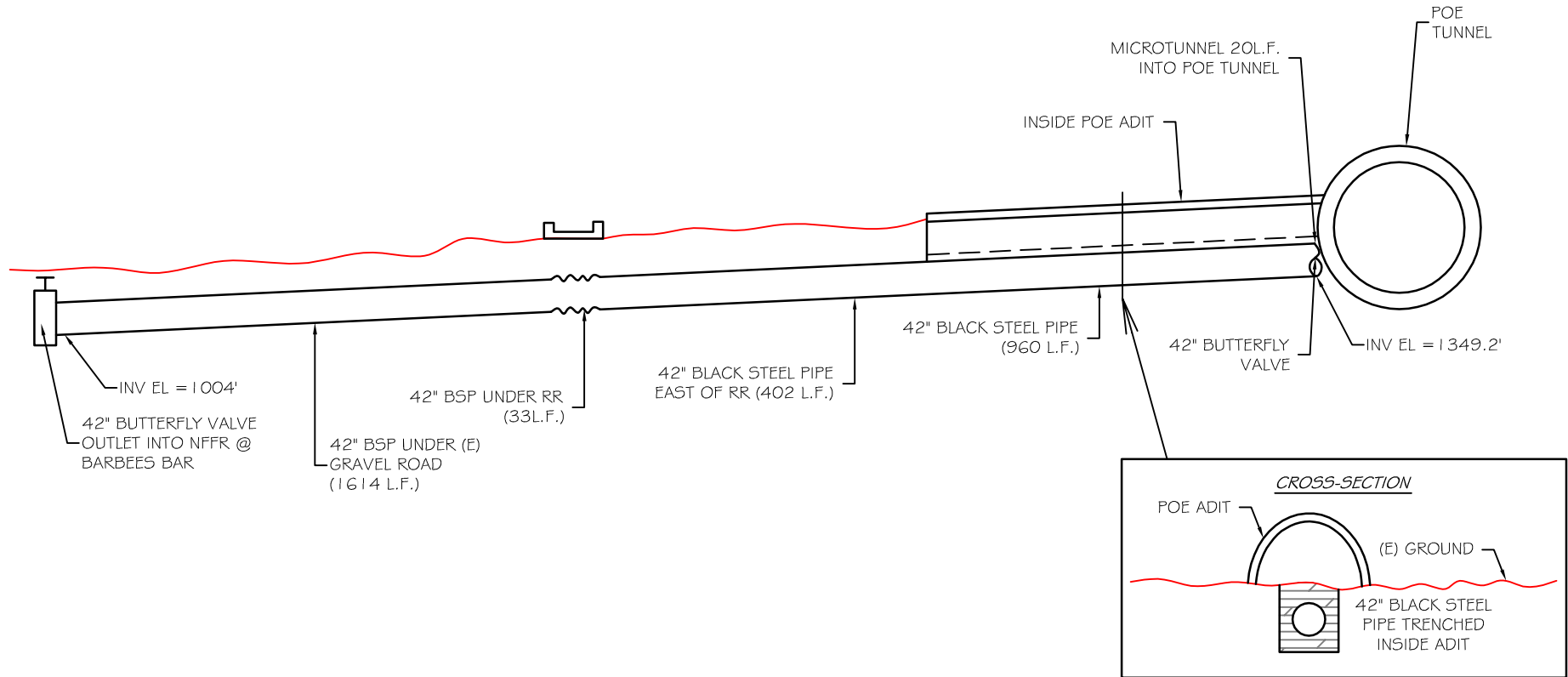
PIPELINE FROM
POE ADIT TO
POE REACH



POE ADIT PIPELINE



POE ADIT TO NFFR AT POE REACH



Measure Name: Divert Lower Cresta Reach Flows and Convey by Submerged Pipeline to Discharge below Poe Dam

Applicable Alternative Category(s): 6a; additional measure for Poe Reach

Description of Measure: Construct about 3-mile long pipeline to convey cold lower Cresta Reach flows to below Poe Dam directly, bypassing Poe Reservoir. The purpose of this measure is to avoid mixing cool Cresta Reach flows with warmer ambient waters of Poe Reservoir. This measure must be combined with the measure bypassing cold Seneca Reach flows around Belden Reservoir, the measure bypassing lower Belden Reach flows around Rock Creek Reservoir, and the measure bypassing lower Rock Creek flows around Cresta Reservoir.

Description of Operations: This measure does not affect PH operations. Operate the diversion system to divert 250 cfs of lower Cresta Reach flows to below Poe Dam and spill the remaining flow over the diversion dam. The diversion rate is supplied by the increased release measure from Cresta Dam. The flow accretion from Grizzly Creek inflows would maintain flows for aquatic habitat in the short reach from the diversion dam to the Cresta PH discharge.

Detailed Description of Facilities Improvements and Design Criteria:

Construct a 7-foot high inflatable/deflatable rubber diversion dam at the lower end of Cresta Reach just upstream of the Cresta PH. Except during summer, the rubber dam would remain in the deflated position. Construct an approximately 3 mile long pipeline to convey cool Cresta Reach flows captured behind the dam to connect to the existing outlet structure for discharge below Poe Dam.

The pipeline starts at the diversion dam and extends about 3 mile to connect to the existing outlet at the bottom of Belden Reservoir. The first segment of the pipeline consists of about 170-feet of 66-inch RCP. The second segment transitions into about 280 feet of 66-inch black steel pipe (BSP) which is connected to the face of Cresta PH and extending to the southeast bank of the NFFR just downstream of Cresta PH. The pipe material then transitions back into 66-inch RCP where it is buried underneath a small existing access road along the southeast bank of the NFFR for approximately 934 feet. The pipe then transitions to 66-inch HDPE and is set anchored to the bottom of Poe Reservoir for the remaining 8,394 feet down to the toe of the dam. The 66-inch HDPE is connected to the existing 66-inche diameter outlet which discharges below Poe Dam.

List of Figures:

- Plan view: Lower Cresta Reach Bypass to Poe Dam.
- Profile: NFFR Lower Cresta Reach Bypass to Poe Dam

Key Design or Construction Uncertainties Requiring Further Study:

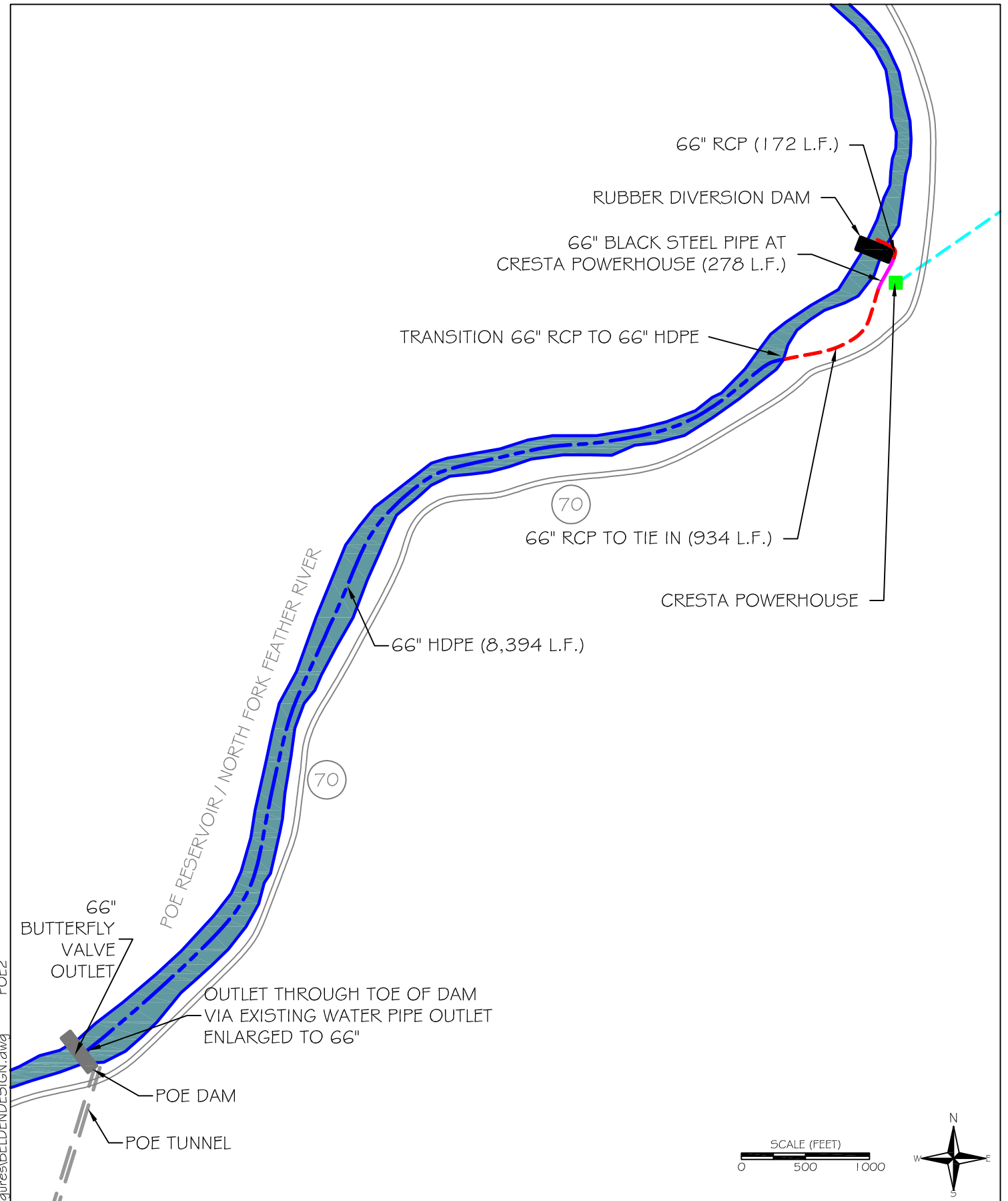
- Connecting a 66-inch black steel pipe to the face the powerhouse will be difficult and costly to anchor against the flow forces of the NFFR and the powerhouse outlet.
- Setting a 66-inch HDPE along the bottom of Cresta Reservoir will be difficult and costly. Design and installation of an anchoring system adequate to withstand the potential forces on the pipe arising from flow momentum and land shifting requires further study.
- Attaching to the existing 66-inch outlet pipe at the toe of the dam will be difficult and costly due to underwater construction.

Discussion: None

COST ESTIMATE FOR LOWER CRESTA REACH BYPASS TO POE DAM OUTLET				
ITEM	QUANTITY	UNIT	UNIT COST	COST
N FORK FEATHER RIVER RUBBER DAM AND INTAKE AT CRESTA PH				
7' high and 84' wide inflatable rubber dam including: mobilization, site prep, foundation, turnout structure and all necessary materials and construction.	1	LS	\$4,170,000	\$4,170,000
		Sub Total NF Feather River Dam		\$4,170,000
66" RCP from Rubber Dam to Concrete Along Face of Cresta Powerhouse				
66-inch Reinforced Concrete Pipe, Class 3	172	LF	309	\$53,148
Grouted Riprap Slope Protection, 3/8 to 1/4 CY Pieces, 18" Thick	354	SY	120	\$42,636
Excavator, Clamshell, 1/2 CY, wet plus addit. Equip	650	CY	26	\$16,660
Backfill, 6" layers, roller compaction operator walking	108	CY	44	\$4,728
Compaction, walk behind vibrating plate, 18" wide, 6" lifts, 4 passes	357	CY	3	\$1,082
Pipe bedding, crushed rock, 1/2" to 3/4"	249	CY	48	\$12,022
1/2 CY bucket wheel mounted front end loader, min haul	529	CY	16	\$8,406
Hauling, 20 mile round trip, 0.4 loads/ hr (Add 15% for Expansion)	529	CY	27	\$14,071
Sediment and Erosion Control (Silt Fence)	172	LF	5	\$870
		Sub total		\$154,000
66" Black Steel Pipe along Concrete Face of Cresta Powerhouse				
66" black steel pipe	278	LF	629	\$174,862
Drill concrete anchor bolts	278	LF	29	\$7,959
Install concrete anchor bolts	278	LF	25	\$7,039
Anchor rings	8	EACH	800	\$6,400
Precast Storm Drain Manhole, 6' I.D., 8' Deep	2	EACH	4,300	\$8,600
		Sub total		\$205,000
66" RCP from Concrete Face of Cresta Powerhouse to N Fork Feather River / Poe Reservoir				
66-inch Reinforced Concrete Pipe, Class 3	934	LF	309	\$288,606
Clearing, medium	0.5	ACRE	1,400	\$700
Compaction, walk behind vibrating plate, 18" wide, 6" lifts, 4 passes	1939	CY	3	\$5,875
Backfill, 6" layers, roller compaction operator walking	588	CY	44	\$25,743
Pipe bedding, crushed rock, 1/2" to 3/4"	1351	CY	48	\$65,226
Excavation, truck mounted, 6-10' deep, 1 CY excavator, Hydraulic Jack hammer	3528	CY	12	\$42,336
1/2 CY bucket wheel mounted front end loader, min haul	2874	CY	16	\$45,668
Hauling, 20 mile round trip, 0.4 loads/ hr (Add 15% for Expansion)	2874	CY	27	\$76,448
Precast Storm Drain Manhole, 6' I.D., 8' Deep	3	EACH	4,300	\$12,900
Grouted Riprap Slope Protection, 3/8 to 1/4 CY Pieces, 18" Thick	1920	SY	120	\$231,245

Sediment and Erosion Control (Silt Fence)	934	LF	5	\$4,726
Remove and reset existing corrugated metal guard rail	934	LF	35	\$32,428
Traffic control, signage	1	LS	29,000	\$29,000
Traffic control, 2 signals	1	LS	51,000	\$51,000
		Sub total		\$912,000
66" HDPE from Poe Reservoir near Cresta PH to Tie-In at Toe of Dam				
66-inch HDPE	8394	LF	390	\$3,273,660
HDPE Pipe Placement, S-lay method with stinger, Mechanical Crane, barge mounted	1	LS	1,300,000	\$1,300,000
Underwater pipe laying preparation of reservoir bottom	1	LS	2,490,000	\$2,490,000
Microtunneling, increase existing 36" fish water bore in dam to 66"	50	LF	2,000	\$100,000
Concrete transition structure, 66" HDPE to 66-dia fish water pipe	1	LS	12,000	\$12,000
Attach 66" HDPE to transition structure and expanded fish water pipe (apx 35' underwater)	1	LS	150,000	\$150,000
66-inch hydraulic operated butterfly valve	1	LS	66,000	\$66,000
		Sub total		\$7,392,000
Mobilization				
Dozer, above 150 HP (3)	1	LS	3,600	\$3,600
Excavator, 1-1.5 CY Diesel Hyd. (2)	1	LS	9,600	\$9,600
Loader (2)	1	LS	2,400	\$2,400
Dump truck, 26 tons (10)	1	LS	6,000	\$6,000
25 ton truck mounted hydraulic crane (2)	1	LS	2,000	\$2,000
Crawler Type Drill, 4" (1)	1	LS	700	\$700
Grout pumper (1)	1	LS	600	\$600
Water truck, 6000 gal (2)	1	LS	1,200	\$1,200
Wash & Screen (1)	1	LS	7,200	\$7,200
Mechanical Dredger, Crane and stinger, barge mounted and all equipment	1	LS	200,000	\$200,000
		Sub total Mob / Demob		\$233,000
			TOTAL	\$13,066,000

F:\Data\2125\CAD\Figures\BELDENDESIGN.dwg POE2

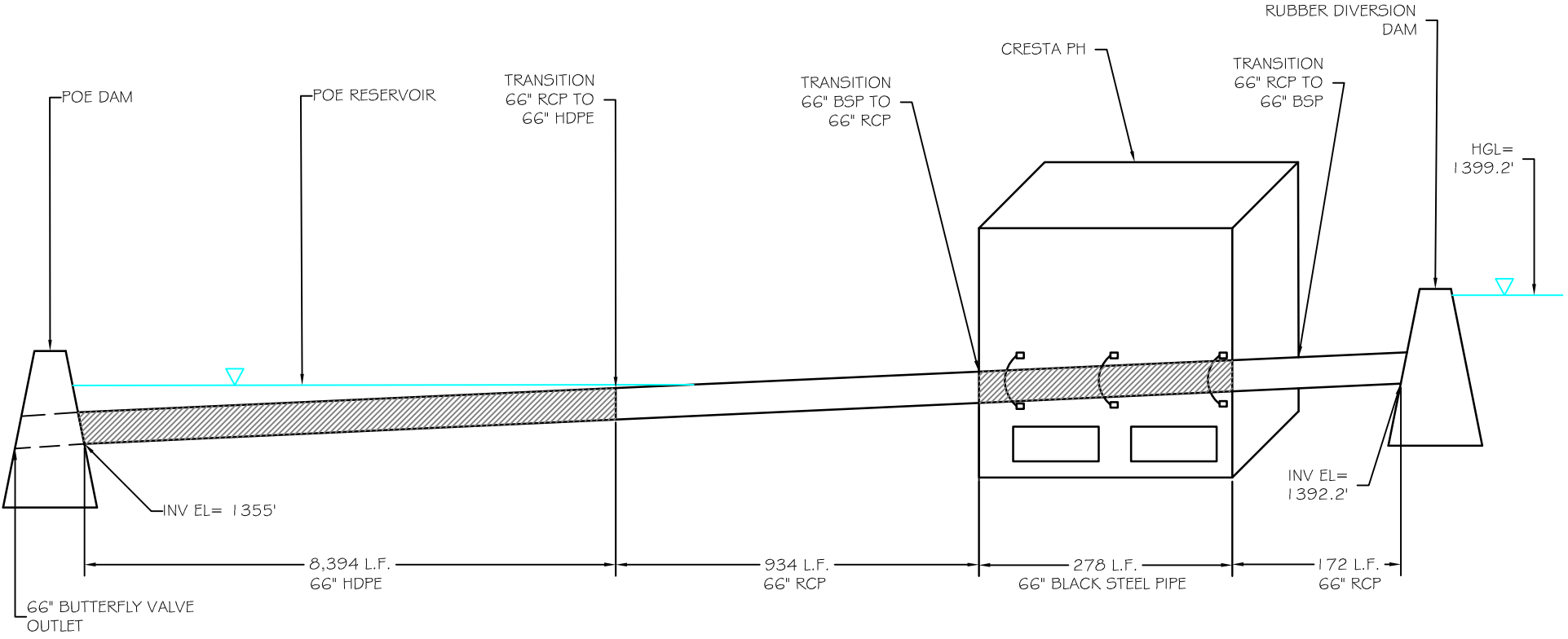


LOWER CRESTA REACH BYPASS TO POE DAM



STETSON
ENGINEERS INC.

NFFR, LOWER CRESTA REACH BYPASS TO POE DAM



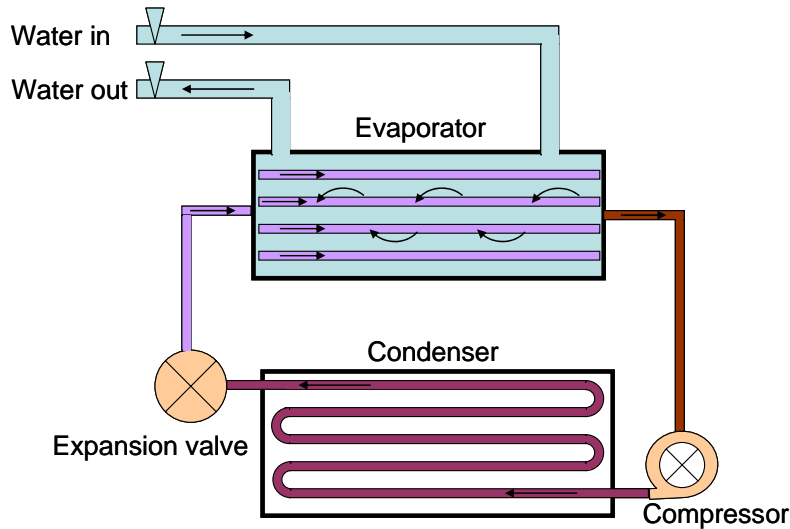
ENLARGE EXISTING 3'-DIA X 40' LONG TO 66" I.D. EX. WATER PIPE THROUGH DAM AND ATTACH 66" HDPE

Measure Name: Construct Mechanical Water Chillers near Rock Creek, Cresta, and Poe Dams

Applicable Alternative Category(s): 4, 5, 6

Description of Measure: Construct a mechanical water chiller to cool reservoir water and deliver it back to the reach just below the Rock Creek, Cresta, and Poe Dams. The purpose of this measure is to reduce the water temperature of flows below the dams.

A water chiller is a machine that removes heat from water by employing a vapor-compression or absorption-refrigeration cycle. Chillers typically made as complete packaged closed-loop systems, including the evaporator, compressor, condenser, and expansion valve (see the following figure). Warm water entering the chiller inlet is cooled by a coil-confined refrigerant and the chilled water is discharged from the chiller outlet. The heat energy taken out of the warm water by the refrigerant is released to the environment through an air- or water-cooled condenser.



Conceptual process flowchart of mechanical water chillers

The cycle begins in the evaporator where a liquid refrigerant flows over the evaporator tube bundle and evaporates, absorbing heat from the chilled water circulating through the bundle. The refrigerant vapor is drawn out of the evaporator by the compressor. The compressor then “pumps” the refrigerant vapor to the condenser raising its pressure and temperature. The refrigerant condenses on or in the condenser tubes, giving up its heat to the cooling air (or water). The high pressure liquid refrigerant from the condenser then passes through the expansion device that reduces the refrigerant pressure and temperature as it enters the evaporator. The refrigerant again flows over the chilled water coils absorbing more heat and completing the cycle.

Description of Operations: This measure does not affect PH operations. Operate the chiller system to divert 150 cfs from Rock Creek Reservoir, 175 cfs from Cresta

Reservoir, and 200 cfs from Poe Reservoir and convey the water to each of the respective chillers. Return the chilled water back to the NFFR right below each dam.

Detailed Description of Facilities Improvements and Design Criteria:

Specifications considered in chiller selection include the ability to handle large flow rate, cooling capacity, and cooling type. Flow requirements in July of a dry year for Rock Creek, Cresta, and Poe Reaches are estimated at 150, 175, and 200 cfs, respectively (see the following table). Depending upon the alternative categories considered, the estimated required temperature reductions range from 3.5°C to 5.0°C. Accordingly, the total heat reduction is estimated at 17,600 – 33,600 tons⁵. Chillers that are typically available on the market have a maximum capacity of about 1,500 tons. Multiple parallel air-cooled chillers are selected for this design.

Cooling Scenarios and Land Size Requirements

	Total Cooling Energy (tons)	Number of Chillers	Estimated Land Size in W x L (ft ²)
Rock Creek Reach (150 cfs)			
from 22.5°C --> 19.0°C	17,700	12	103x66
from 21.0°C --> 19.0°C	10,100	7	
from 20.5°C --> 19.0°C	7,600	5	
Cresta Reach (175 cfs)			
from 22.0°C --> 18.3°C	22,300	15	89x93
from 21.0°C --> 18.3°C	16,400	11	
from 20.5°C --> 18.3°C	13,500	9	
Poe Reach (200 cfs)			
from 22.5°C --> 17.4°C	33,700	22	110x120
from 21.0°C --> 17.4°C	23,600	15	
from 20.5°C --> 17.4°C	20,300	13	

In order to avoid pumping cost, it is important to identify a suitable location below each dam to deploy chillers so that warm reservoir water can be conveyed to the chillers by gravity and the chilled water can be delivered back to the reach right below each dam by gravity. The following criteria were also used for site selection in addition to gravity flow:

- 4) Close to upper end of the reach;
- 5) Large enough open land space; otherwise a constructed deck is needed;
- 6) Above 100-yr flood plain;

The selected locations that meet the above criteria for the Rock Creek, Cresta, and Poe reaches are shown in Figures 1a-1c. Because there is no available land space along the Cresta reach for deployment of multiple chillers, a constructed a deck is proposed.

Example chiller layouts, based on the July 2002 water temperature and meteorological conditions (most conservative; requires the most chillers), are shown in Figures 2a-2c. Water is diverted to chillers via a reinforced concrete pipe (RCP) from the low level outlets of the dams (Figures 1a-1c and Figures 3a-3c). The cooled water is then released

⁵ Ton is an energy unit here. Ton = BTU/hr ÷ 12,000; BTU/hr = gallons per hour × 8.33 × ΔT (°F)

back by way of another RCP to the upper end of each reach, i.e., just below the reservoir dam.

List of Figures:

- Figures 1a – 1c: Plan view of chiller locations and piping:
- Figures 2a – 2c: Plan view of example chiller layouts and piping
- Figures 3a – 3c: Profile of chiller designs

Key Design or Construction Uncertainties Requiring Further Study:

- Siting and design of the chiller for a confirmed location above the 100-year floodplain to avoid flood damages while being able to deliver the chilled water back to the NFFR right below each dam by gravity requires further study.
- The design was mainly based on the vendor's quote which requires further verification.

Discussion:

A mechanical cooling tower was also considered to cool reservoir water. However, preliminary analysis indicates that a mechanical cooling tower is not feasible to cool waters in Rock Creek, Cresta, and Poe Reservoirs to below 20°C because the ambient wet bulb temperatures at the sites are already close to 20°C (or 68°F) in July and August based on the meteorological data observed at Rock Creek Dam station and Poe Dam station by PG&E. Theoretically, the ambient wet bulb temperature must be lower than target temperature by at least 5°F (or about 3°C) to make a mechanical cooling tower feasible. (Note: Wet bulb temperature is the temperature indicated by a moistened thermometer bulb exposed to the air flow. The evaporation of water from the thermometer has a cooling effect, so the wet bulb temperature is always lower than the dry bulb temperature (i.e., temperature measured by a normal thermometer) except when there is 100% relative humidity.)

Cost Estimates of Each Installation of Chillers

	Cost of Chillers				Cost of Construction (\$)	Total Installation Cost (\$)	Annual Energy Consumption		
	Number of Chillers	Unit Chiller Cost (\$) ¹	Unit Startup Fee (\$) ¹	Subtotal (\$)			Unit Power Demand at Full load (kW) ¹	Running Time Period (days/year)	Energy Consumption (KWh ×10 ⁶ /year)
Rock Creek Reach									
from 22.5°C --> 19.0°C	12			4,620,000		6,096,000			12.11
from 21.0°C --> 19.0°C	7	382,000	3,000	2,695,000	1,476,000 ²	4,171,000	678.4	62	7.07
from 20.5°C --> 19.0°C	5			1,925,000		3,401,000			5.05
Cresta Reach									
from 22.0°C --> 18.3°C	15			5,775,000		8,349,000			15.14
from 21.0°C --> 18.3°C	11	382,000	3,000	4,235,000	2,574,000 ³	6,809,000	678.4	62	11.1
from 20.5°C --> 18.3°C	9			3,465,000		6,039,000			9.09
Poe Reach									
from 22.5°C --> 17.4°C	22			8,470,000		11,750,000			22.21
from 21.0°C --> 17.4°C	15	382,000	3,000	5,775,000	3,280,000 ⁴	9,055,000	678.4	62	15.14
from 20.5°C --> 17.4°C	13			5,005,000		8,285,000			13.12

- 1) From vendor's quote, see attached.
- 2) Includes two 48-inch, 900 ft long reinforced concrete pipes and installation.
- 3) Includes two 48-inch, 350 ft long reinforced concrete pipes and installation and constructed deck for chiller deployment.
- 4) Includes two 48-inch, 2,000 ft long reinforced concrete pipes and installation

Figure 1a. Plan view of chiller location on Rock Creek Reach; Pipe size = 4 ft; flow rate = 150 cfs



Figure 1b. Plan view of chiller location on Cresta Reach; Pipe size = 4 ft; flow rate = 175 cfs



Figure 1c. Plan view of chiller location on Poe Reach; Pipe size = 4 ft; flow rate = 200 cfs



Figure 2a Example chiller layout and piping on Rock Creek Reach (Not to Scale)

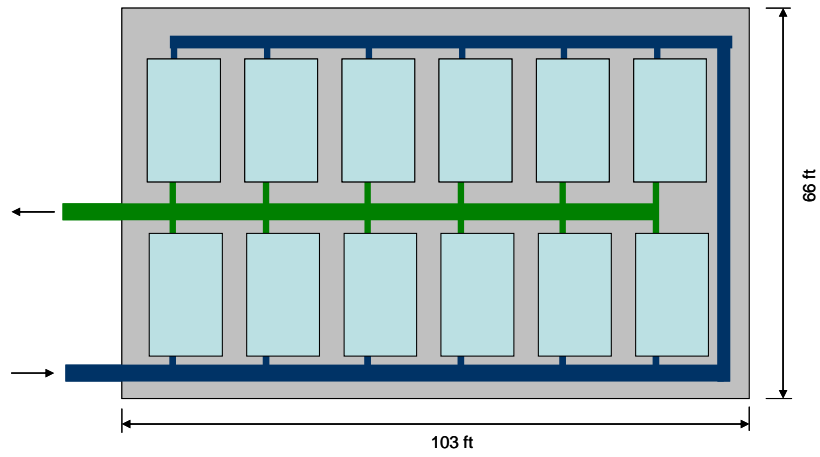


Figure 2b Example chiller layout and piping on Cresta Reach (Not to Scale)

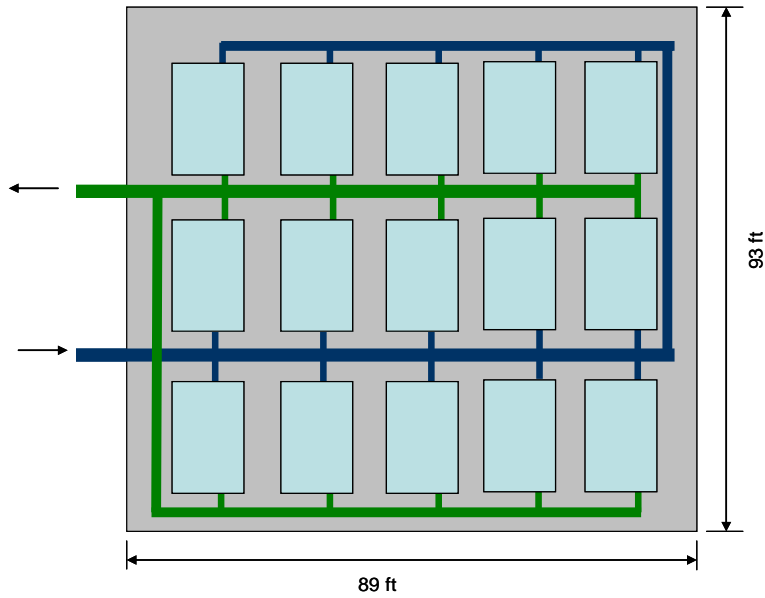


Figure 2c Example chiller layout and piping on Poe Reach (Not to Scale)

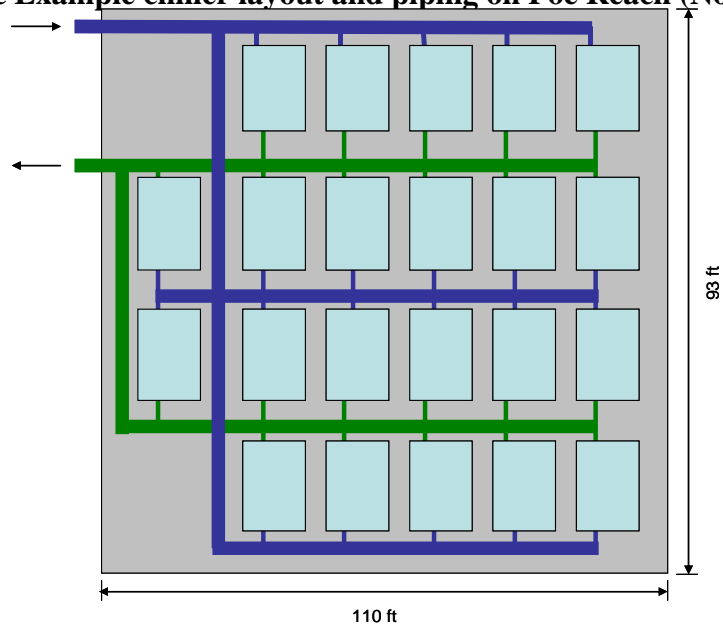


Figure 3a Profile of chiller design on Rock Creek Reach; Chillers are on river bank
(Not to Scale).

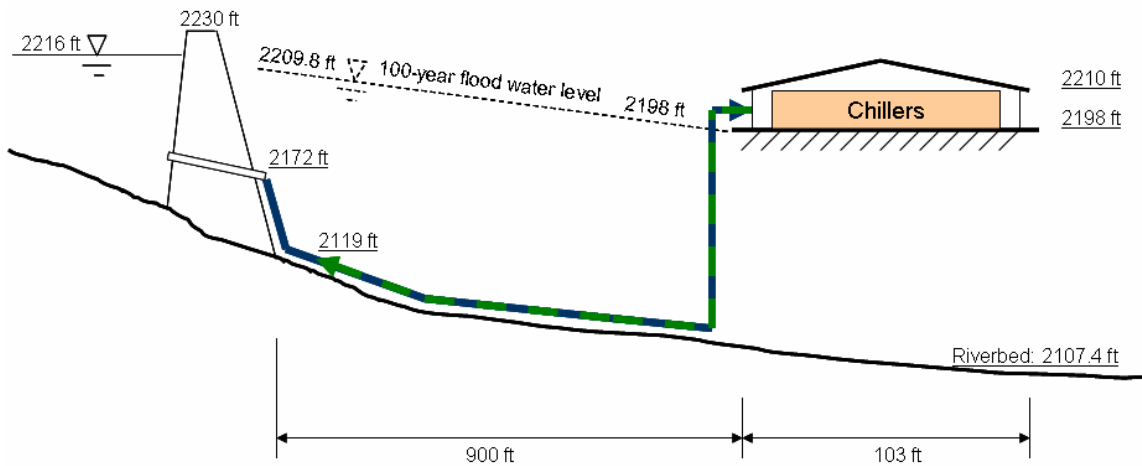


Figure 3b Profile of chiller design on Cresta Reach; Chillers are on a constructed deck
(Not to Scale).

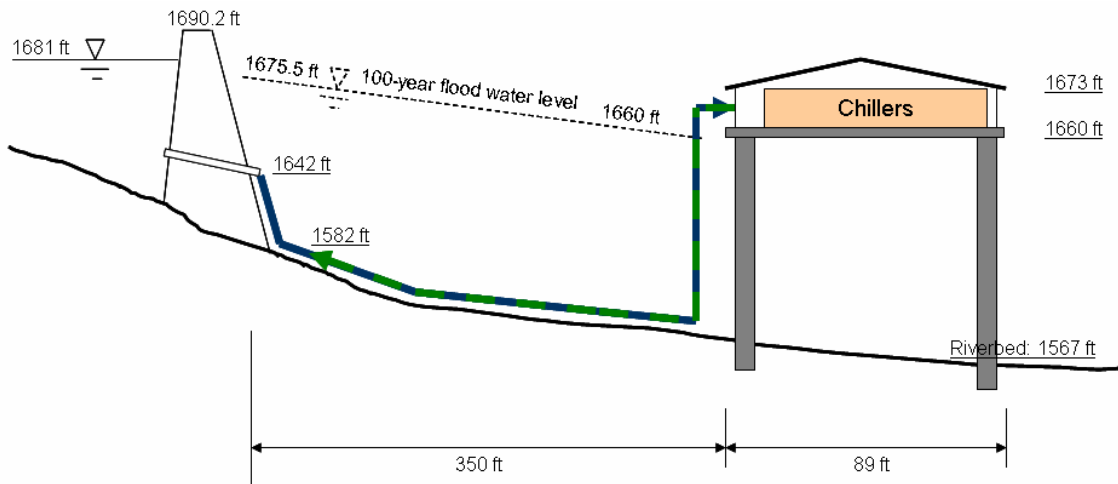
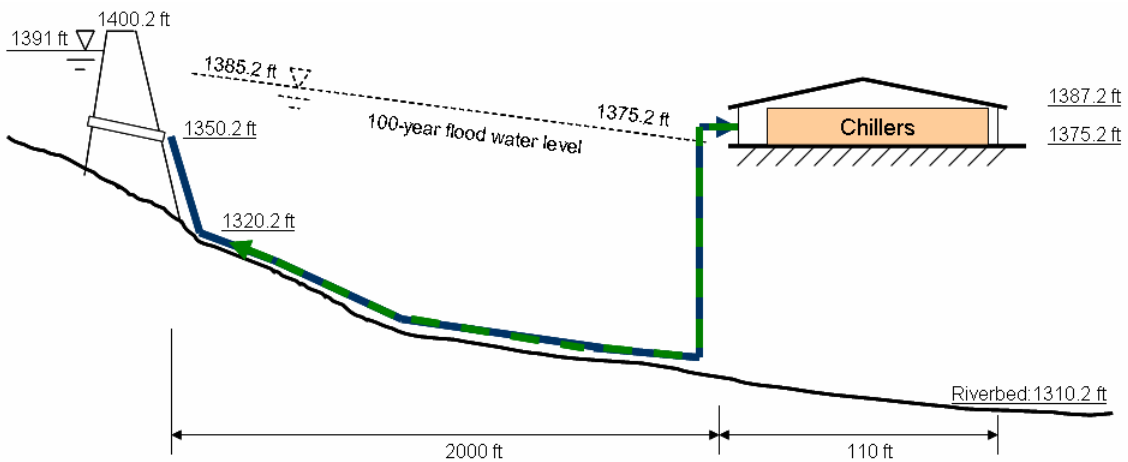


Figure 3c Profile of chiller design on Poe Reach; Chillers are on river bank
(Not to Scale).





APPLICATIONS RATING
Dunham-Bush

WCOX180 clr:2pW5Q end:2pP5Q std. Q

Conditions of Service

Hertz	80	Unit efficiency (EER)	28.0
Percent of full load	100%	Unit efficiency (kW/Ton)	0.429
Capacity (Tons)	1,581.6	NPLV	0.480
Unit power (kW)	678.4	Refrigerant	R-134a
Compressor(s):	3216		

Notes

- Not submitted to ARI for certification under standard-550/590.

Evaporator

Fluid	Water	Pressure drop (psi/ft w.g.)	3.1/7.1
Entering fluid temp. (°F)	72.0	Pass arrangement	1
Leaving fluid temp. (°F)	66.0	Tube velocity (ft/s)	5.6
Fluid flow rate (gal/min)	6,333.1	Fluid freezing point (°F)	32.0
Fouling factor (hr-ft ² -°F/Btu)	0.00010		
Model(s):	W5Q		

Condenser

Fluid	Water	Pressure drop (psi/ft w.g.)	2.1/4.9
Entering fluid temp. (°F)	85.0	Pass arrangement	1
Leaving fluid temp. (°F)	94.0	Tube velocity (ft/s)	4.1
Fluid flow rate (gal/min)	4,744.9	Fluid freezing point (°F)	32.0
Fouling factor (hr-ft ² -°F/Btu)	0.00025		
Model(s):	P5Q		

NPLV Points

% Full load	Tons	kW	kW/Ton	Cond. EFT	Type
100%	1,581.6	678.4	0.429	85.0	Actual
75%	1,186.2	504.7	0.425	75.0	Actual
50%	790.8	395.5	0.500	65.0	Actual
25%	395.4	272.3	0.689	65.0	Actual

Part Load Points

% Full load	Tons	kW	kW/Ton	Cond. EFT	Type
100%	1,581.6	678.4	0.429	85.0	Actual
75%	1,186.2	504.7	0.425	75.0	Actual
50%	790.8	395.5	0.500	65.0	Actual
25%	395.4	272.3	0.689	65.0	Actual

PERFORMANCE SUMMARY • CH-1**DUNHAM-BUSH®**

Untitled

Standard Equipment**Unit**

- All units are painted with an acrylic air dried enamel
- Micro computer control cabinet mounted
- Positive displacement open-drive oil pump
- Lights for: Control power on, Compressor enabled, General alarm light
- Operating charge of refrigerant and oil

Cooler

- Flooded type shell and tube
- Cleanable and removable integral finned copper tubes
- Victaulic water connections
- Removable heads
- Single pressure relief device 1.25" FPT
- Vent and drain plugs for each head
- Diffuser and baffle plates
- Oil recovery system
- ASME coded on the refrigerant side, section 8, Div. One "Unfired Pressure Vessels"

Compressor

- D/B rotary helical axial compressor
- Slide valve control infinitely variable to as low as 10%
- Load/Unload solenoid valves
- Motor mount for positive alignment
- Thrust and journal bearings
- Rotors machined from AISI 1141 bar stock
- Cast iron housing
- Shaft seal and seal oil cooler
- Positive pressure lubrication system
- Gear type open drive oil pump
- Replaceable core oil filter
- Suction check valve

External Oil Separator & Reservoir

- ASME coded, Section 8, Division one
- Thermostatically controlled immersion heaters

Condenser

- Cleanable shell and tube type
- Cleanable and replaceable integral finned copper tubes
- Victaulic water connection
- Removable heads
- Vent and drain plugs for each head
- Sized for full pumpdown capacity
- Dual pressure relief devices 1" FPT
- ASME coded on the refrigerant side, Section 8, Division one "Unfired Pressure Vessels"

Controls

- Microcomputer control direct digital type, 2 line, 80

Controls (cont.)

character with push button keyboard, menu driven software, LCD display

Control inputs

- Leaving water temperature
- Cooler refrigerant pressure
- Condenser refrigerant pressure
- Oil pressure
- Compressor amp draw
- Compressor elapsed time
- Percent slide valve loading
- Reservoir oil temperature
- Seal oil temperature
- Water temperature reset valve
- Demand limit reset valve
- Compressor starter status
- Oil pump starter status
- Water flow switch status
- External start/stop command status

Refrigerant Controls

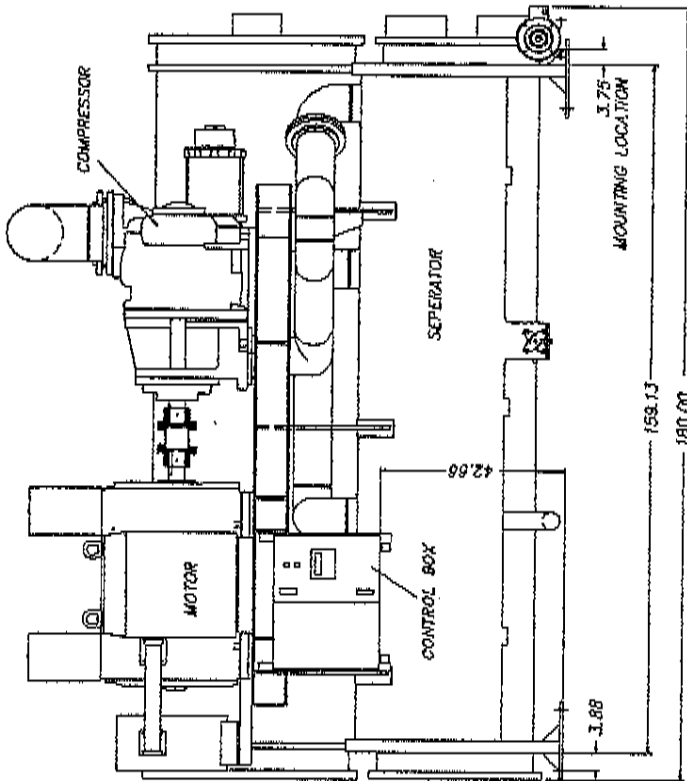
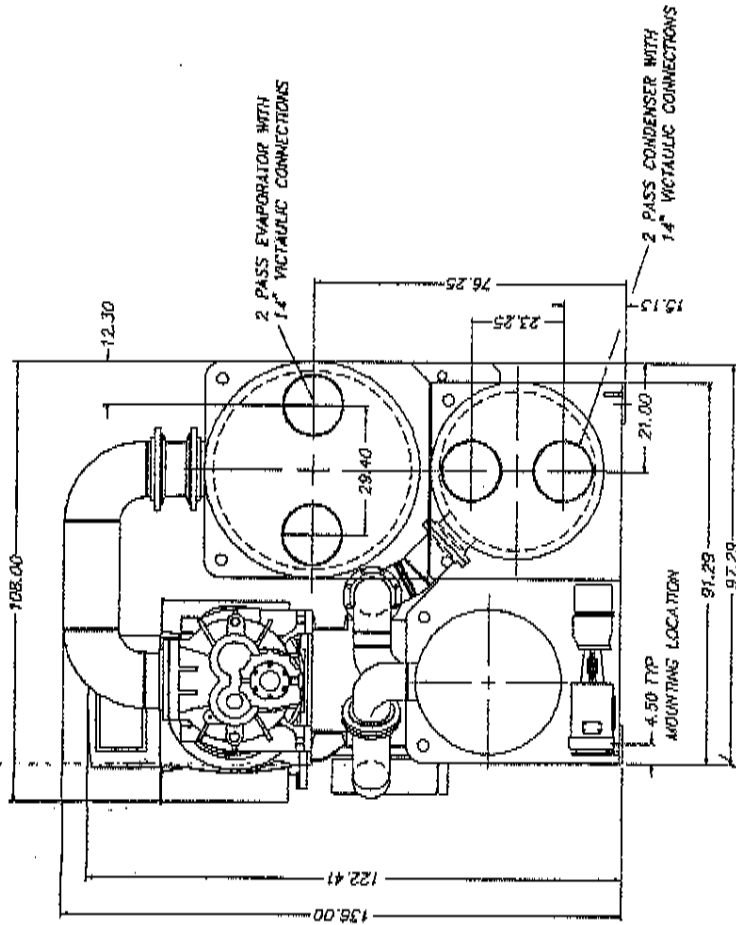
- Finite refrigerant motorized valve
- Liquid refrigerant level sensor for cooler
- Compressor load, unload solenoid valves

Control Function

- Low refrigerant suction pressure
- High refrigerant discharge pressure
- Low oil temperature
- Freeze protection
- High reservoir oil temperature
- High seal oil temperature
- Compressor starter failure
- Oil pump starter failure
- Compressor run error
- Power loss
- Chilled water flow loss
- Sensor error
- Compressor over current
- Anti-recycle
- Retains the latest eight alarm conditions with time of failure in alarm history

Unit Conformances

- ASME Section 8 for unfired vessel construction
- ASME Standard 31.5 Refrig. Piping
- ASHRAE 90A, 1980
- NEC, NEMA, ANSI/ASHRAE 15
- Rated in accordance with ARI 550/590-98
- Rated in accordance with ARI Standard-550/590-98.



WCOX-160

2 PASS EVAPORATOR, RH CONNECTION SHOWN
 2 PASS CONDENSER, RH CONNECTION SHOWN
 WEIGHTS:

SHIPPING - 57,000 LBS

OPERATING - 65,000 LBS

* ALL DIMENSIONS ARE IN INCHES

* ALL DIMENSIONS ARE PRELIMINARY

DO NOT SCALE THIS DRAWING

DUNHAM-BUSH, INC.	
COMPRESSOR PRODUCTS DIV. WASHINGTON, D.C. USA	
SCALE TO 0107226092	APP. DATE
TITLE DWG-OUTLINE WCOX	
BRUNAL USAGE BODY-160	DATE
DRAWN BY WNF	4-97
WCOX-160	1 OF 1 SHEETS