

# RECLAMATION

*Managing Water in the West*

Technical Memorandum 86-68290-09-05

## 2009 Effectiveness of a Non-Physical Fish Barrier at the Divergence of the Old and San Joaquin Rivers (CA)

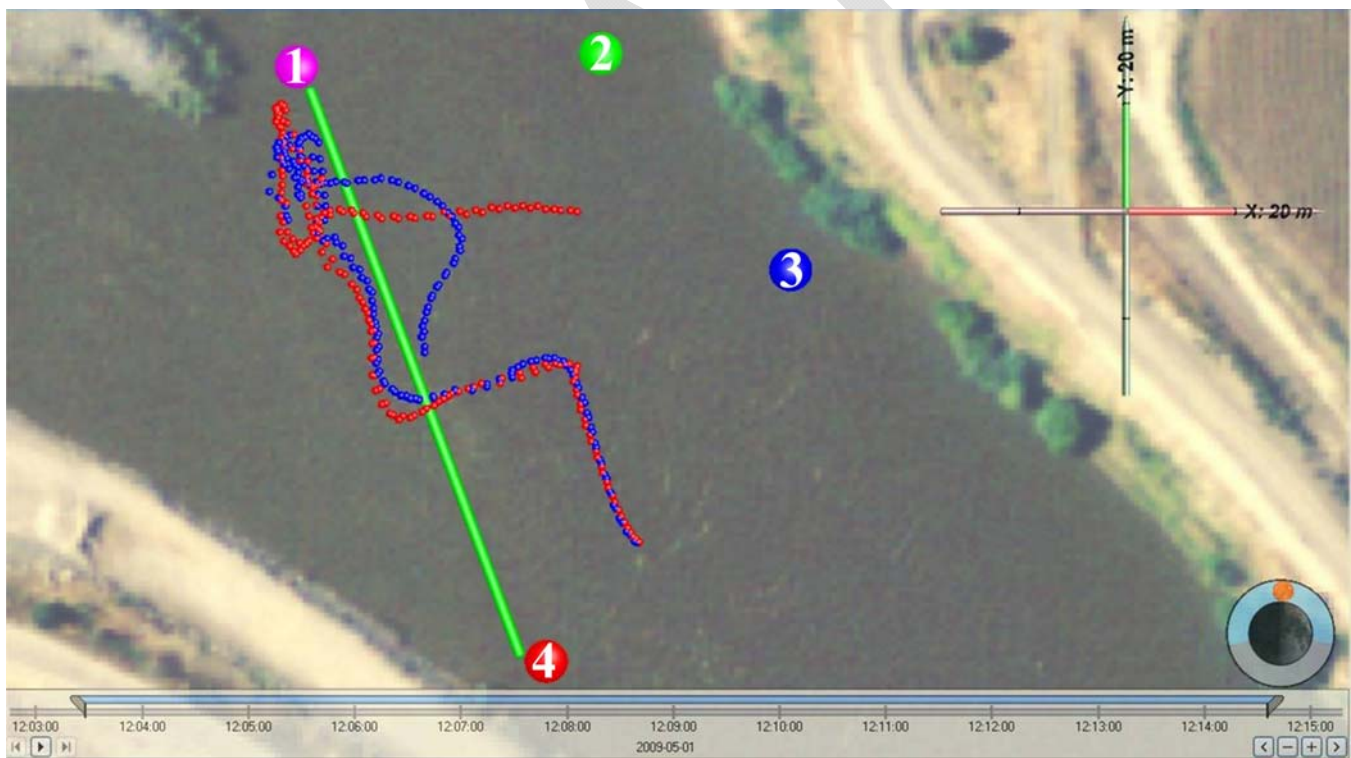

U.S. Department of the Interior  
Bureau of Reclamation  
Technical Service Center  
Denver, Colorado

September 2009

## **Mission Statements**

The mission of the Department of the Interior is to protect and provide access to our Nation's natural and cultural heritage and honor our trust responsibilities to Indian Tribes and our commitments to island communities.

The mission of the Bureau of Reclamation is to manage, develop, and protect water and related resources in an environmentally and economically sound manner in the interest of the American public.

**Technical Memorandum 86-68290-11**

# **2009 Effectiveness of a Non-Physical Fish Barrier at the Divergence of the Old and San Joaquin Rivers (CA)**

*by*

**Mark D. Bowen**

U.S. Department of Interior/Bureau of Reclamation  
Sixth and Kipling, Building 67  
Denver, Colorado 80225-8290  
303 445 2222

**Steve Hiebert**

U.S. Department of Interior/Bureau of Reclamation  
Sixth and Kipling, Building 67  
Denver, Colorado 80225-8290  
303 445 2206

**Charles Hueth**

SAIC, Inc. - U.S. Department of Interior/Bureau of Reclamation  
Sixth and Kipling, Building 67  
Denver, Colorado 80225-8290  
303 445 2240

**Vivien Maisonneuve**

SAIC, Inc. - U.S. Department of Interior/Bureau of Reclamation  
Sixth and Kipling, Building 67  
Denver, Colorado 80225-8290  
303 445 2240



U.S. Department of the Interior  
Bureau of Reclamation  
Technical Service Center  
Denver, Colorado

**PEER REVIEW DOCUMENTATION  
PROJECT AND DOCUMENT INFORMATION**

Project Name: 2009 Effectiveness of a Non-Physical Fish Barrier at the Divergence of the Old and San Joaquin Rivers (CA)

WOID: SJRCM, N12-1852-7916-7000-00-0-0

Document: USDI/Bureau of Reclamation, Technical Memorandum 86-68290-09-05  
Date: 9/30/09 Date Transmitted to Client: Draft 1, 9/30/09

Team Leader: Mark Bowen

Document Author(s)/Preparer(s): Mark Bowen, Steve Hiebert, Chuck Hueth, and Vivien Maisonneuve

Peer Reviewer: Raymond Bark

**REVIEW REQUIREMENT**

Part A: Document Does Not Require Peer Review

Explain \_\_\_\_\_  
\_\_\_\_\_  
\_\_\_\_\_

Part B: Document Requires Peer Review: SCOPE OF PEER REVIEW

Peer Review restricted to the following Items/Section(s): Reviewer: Ray Bark

All sections were reviewed to certify the document meets Reclamation policy and professional standards for the fisheries biology field.

**REVIEW CERTIFICATION**

Peer Reviewer - I have reviewed the assigned Items/Section(s) noted for the above document and believe them to be in accordance with the project requirements, standards of the profession, and Reclamation policy.

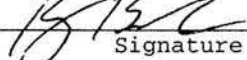
Reviewer:   
Signature

Review Date: Sept. 28, 2009

Reviewer: \_\_\_\_\_  
Signature

Review Date: \_\_\_\_\_

Preparer - I have discussed the above document and review requirements with the Peer Reviewer and believe that this review is completed, and that the document will meet the requirements of the project.

Team Member: \_\_\_\_\_ Date: \_\_\_\_\_  
Signature

On the cover: “Double Predation.” Smolt 6786 was eaten by a predator on approximately 4/30/09, 20:40 hr then that predator ate smolt 6800 on approximately 5/1/09, 11:21 hr.

## INTRODUCTION

The US Department of the Interior/Bureau of Reclamation (Reclamation) worked in coordination with Fish Guidance Systems (Southampton, England), Jacobs Engineering (Southampton, England), EIMCO Water Technologies (Salt Lake City, UT), Hydroacoustic Technology Inc. (Seattle, WA), the San Joaquin River Group Authority (Davis, CA) and the California Department of Water Resources (Sacramento, CA) to design, implement, and monitor a non-physical barrier called the Bio-Acoustic Fish Fence (BAFF). The BAFF was deployed upstream of the divergence (Divergence) of the San Joaquin River (SJR) and Old River (OR). The BAFF intends to deter anadromous salmonid juveniles from entering Old River. The BAFF is comprised of three components: sound, bubble curtain, and hi-intensity light-emitting diode (LED) strobe lights. The BAFF was deployed in the San Joaquin River immediately upstream of the Old River and it will be referred to in this document as the Old River Barrier (ORB) or BAFF.

Reclamation assisted in planning the deployment of the ORB. We provided technical assistance in delivering sound, bubble, and strobe light stimuli to anadromous salmonids at the same intensity as our laboratory model in the Water Resources Research Laboratory (Denver, CO). Our laboratory model showed statistically significant deterrence of Chinook juveniles caused by a BAFF (Bowen et al., 2008) similar to that we installed at the Divergence.

The monitoring of the ORB was conducted by Reclamation with the cooperation of the Vernalis Adaptive Management Program (VAMP) team. The VAMP team used acoustic telemetry to assess survival rate in several routes through the Sacramento-San Joaquin Rivers Delta (Delta).

The primary release point for the 2009 VAMP experiments was Durham Ferry, several miles upstream of the San Joaquin River-Old River Divergence. The Chinook smolts with acoustic transmitters that were released there and survived to the Divergence were detected by an array of hydrophones deployed in the vicinity of the Divergence. These detections provided measures of Deterrence Efficiency and Protection Efficiency as the Chinook smolts pass through the area of the ORB. Fish that were deterred by the ORB and remained in the San Joaquin River are thought to be more likely to survive than fish that enter Old River. Some data that suggest survival is higher in the San Joaquin River path can be found in Holbrook et al., 2009. Chinook smolts that pass through the barrier undeterred are more likely to be entrained into the Central Valley Project and State Water Project intakes that are located on Old River.

In addition to acoustic telemetry, we used one other evaluation methodology. A Dual-frequency Identification Sonar (DIDSON) camera was deployed immediately upstream of the barrier. The DIDSON recorded images throughout the period after each VAMP release. These DIDSON recordings were used primarily to observe the behavior of fishes in the vicinity of the barrier and are not easily quantifiable.

## METHODS

The BAFF (Fish Guidance Systems, Southampton, England) installation was completed by April 20, 2009. After installation of the BAFF, we installed an HTI (Hydroacoustic Technology, Inc. (<http://www.htisonar.com/index.htm>)) 4-hydrophone, 2-Dimensional (2D) tracking system. Next, we installed the DIDSON camera. All installations were complete before the first VAMP Chinook smolt release was completed 4/23/09, 17:05 hr. With this equipment we were able to monitor the seven experimental releases of telemetred Chinook smolts by the VAMP team.

### *Non-Physical Barrier Description*

The BAFF fish barrier combines a number of stimuli and operating principles to maximize fish guidance into a designated channel or collection point. These include customized sound signals, directional strobe lighting and an air bubble curtain (Figure 1). In our model studies at the Water

Resources Research Laboratory (Denver, CO), the setup was like that in Figure 1.

The sound, light, and bubble methodologies were selected to confine the effective range of the stimuli to provide precise directional control over fish movements. The deployment and various barrier elements and their interactions are described below.

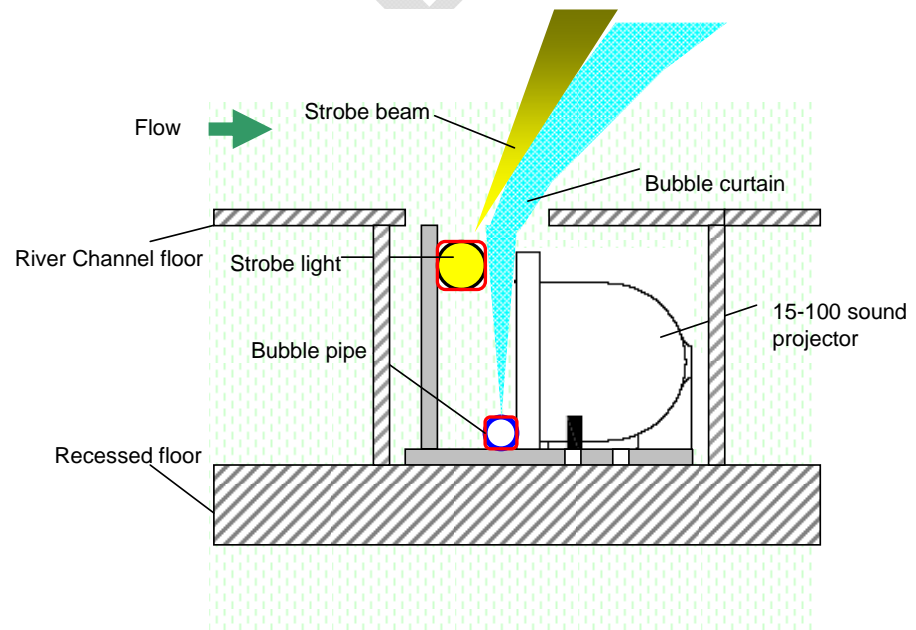

**Figure 1. Fish barrier system set-up.**

### Non-Physical Barrier Deployment

The ORB was 112 m long (Figure 2) and was at a 24 degree angle incident to the San Joaquin River west shore at the point of origin. The BAFF components, sound, air, and light were attached to a truss style frame. This frame was suspended 0.45 m off the bottom of the river (Figure 3). This distance was deemed sufficient to allow sturgeon, green and white, to pass under the BAFF.

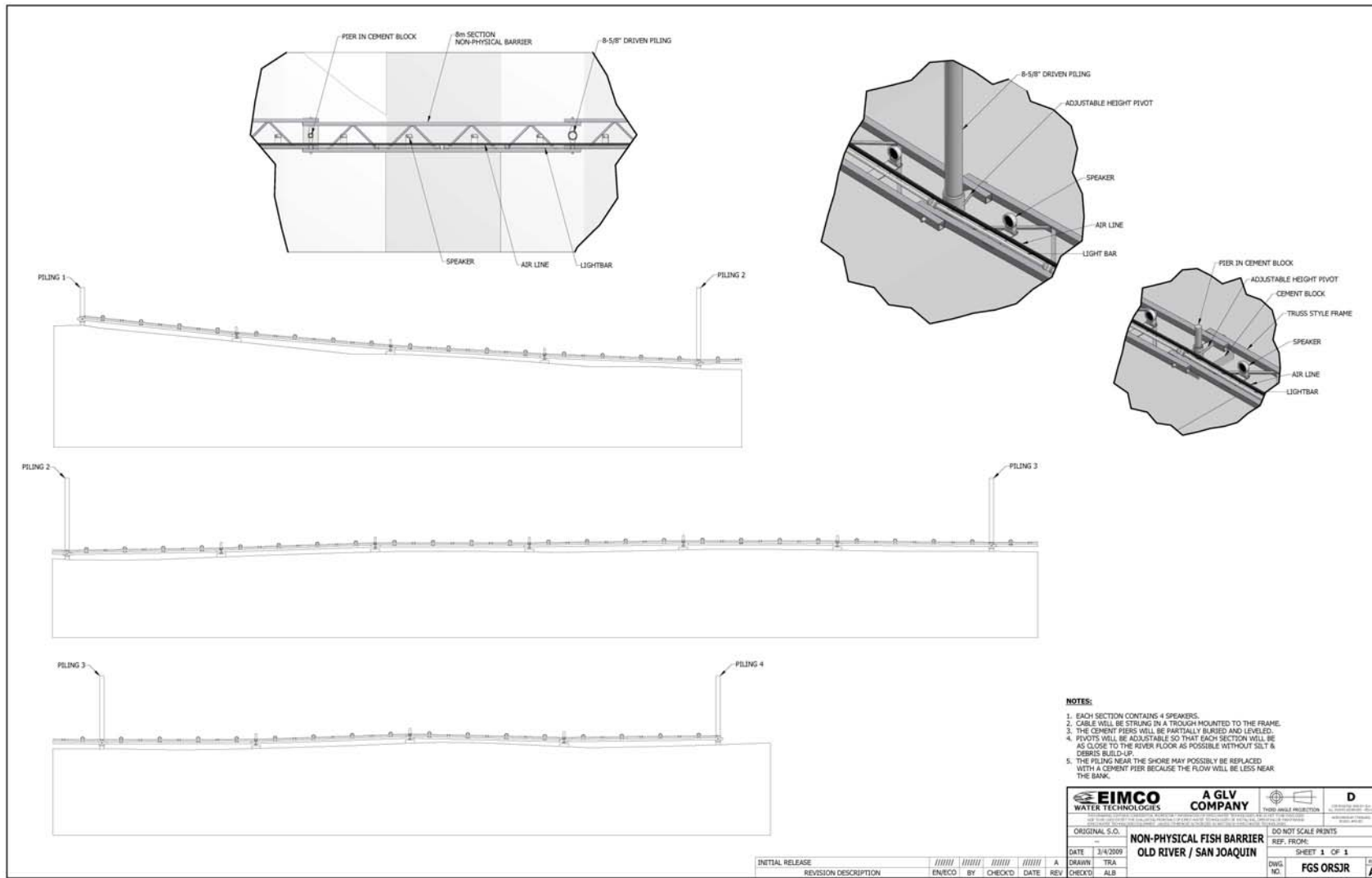

Figure 2. Non-physical barrier design in the San Joaquin River just upstream of the Old River divergence. The truss-style frame was lifted by pilings and cement piers 0.45 m off the bottom for the entire length of the barrier.

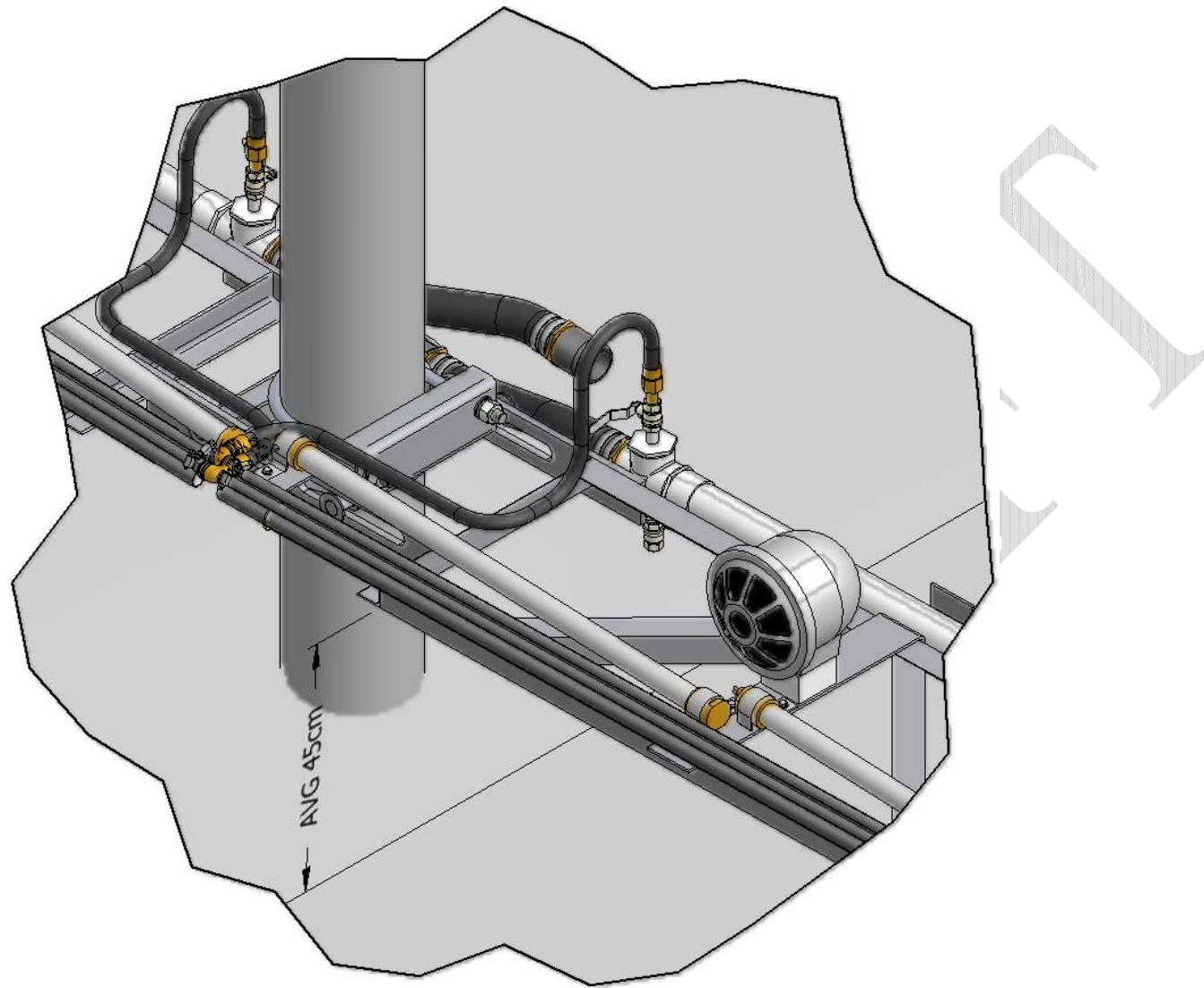

Figure 3. In this detailed drawing of the truss-style frame, with the BAFF components visible, the distance from the frame to the substrate is indicated as 45 cm. This was the space maintained between the BAFF components and the substrate along the entire 112 m of the BAFF.



## The Acoustic Stimulus

Fish Guidance Systems (FGS) investigated the sensitivities of different fish species and found the most effective acoustic deterrents for multiple species applications fall within the sound frequency range of 5 to 600 Hz. The combined fish barrier generated frequencies within this range at source levels of around 160 dB re 1  $\mu$ Pa @ 1m. The signals were delivered by electromechanical transducers, or 'sound projectors'. For the ORB installation, FGS Model 15-100 MkII sound projectors were used, allowing fine control of sound levels within the experimental arena. The sounds were generated by an FGS Model 1-08 Signal Control Unit which fed an FGS Model 400 (400 watt) Power Amplifier, which was linked by cable to the sound projectors.

## The Bubble Curtain

The primary function of the bubble curtain was to contain the sound generated by the sound projectors. Using a unique principle patented by FGS, the sound was encapsulated within the bubble curtain, allowing a precise linear wall of sound to be developed. The bubble curtain was generated by passing compressed air (~0.2 bar pressure) into a perforated rubber pipe running along the base of the barrier. Air flow rate was typically around 2.0 liters per second per 1 meter length of barrier. The alignment of the bubble curtain determined the guidance line of fish, enabling them to be directed toward the San Joaquin River. The trapping of the sound signal within the air curtain prevented any saturation of the experimental area with sound, levels typically falling to ambient at a range of 3 m from the bubble curtain axis (Appendix 1).

## Strobe Lighting

Fish Guidance Systems Linear Strobe Light Arrays were used to generate the visual stimulus. The strobe lights are LED powered devices that created white light in a vertically orientated beam of 22° beam width. The light arrays were used in the barrier and were aligned such that the beam projects onto the rising bubble curtain. This served to reflect the beam and improved visibility from the direction of approaching fish. The narrow vertical beam angle minimized light saturation within the experimental arena. The strobe light system was driven by a low voltage source (<25 V dc) at a flash rate of 360 per minute.

## Sound Measurements

Measurements of sound emitted by the barrier were measured at 0.5 m depth and are shown in Appendix 1. Sound measurements were taken adjacent to the four piles (Pile 1, nearest to the on-shore origin, Pile 4 near terminus), and nominally at the pile itself (shown as "0 m") and at distances of 1 and 3 m upstream and downstream, orthogonal to the barrier. Waypoints are shown and were recorded at the water surface using a hand-held GPS unit. Ambient sound level measurements (barrier off) were made only at Pile 1.

Sound pressure levels (SPLs) were measured using a Bruel and Kjaer Model 2204 hydrophone connected to Bruel and Kjaer Charge Amplifier and mV meter; milliVolt readings were then

converted to SPLs (dB re 1  $\mu$ Pa) using calibration curves for the hydrophone. All instruments were calibrated to international standards.

### Acoustic Telemetry Tracking

The ORB was deployed in the San Joaquin River immediately upstream of Old River. To monitor the acoustic tags implanted in the juvenile Chinook salmon, we deployed 4 hydrophones (Figure 2) to provide for 2D tracking in the vicinity of the ORB. Each hydrophone was connected by cable to the HTI Model 291 4-port receiver.

The acoustic tag tracking system consisted of acoustic tags implanted in fish, hydrophones deployed underwater, and an on-shore receiver and data storage computer. Each acoustic tag transmits an underwater sound signal or acoustic "ping" that sends identification information about the tagged fish to hydrophones. The hydrophones were deployed at known locations within the array to maximize spacing of the hydrophones in two (or three) dimensions. For three dimensional tracking, tags must be received on at least four hydrophones; for two dimensional tracking, tags must be received on at least three hydrophones.

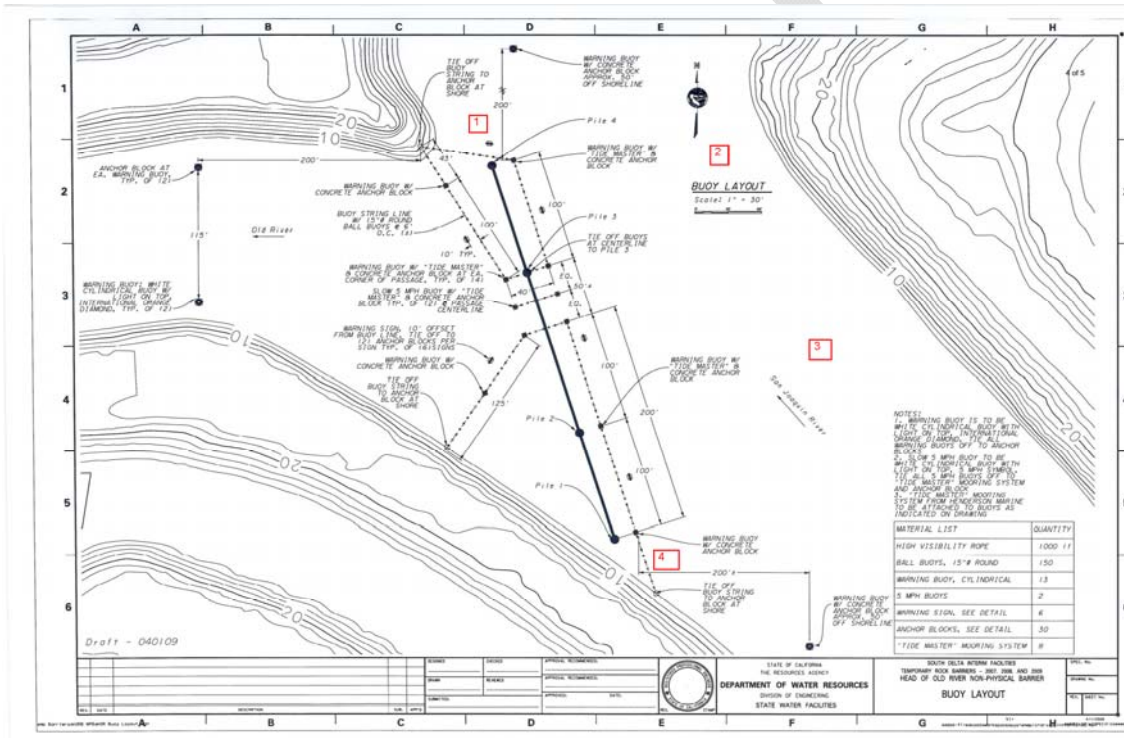

Figure 4. Divergence of Old River and San Joaquin River, CA. The bold black line indicates the BAFF location. The red squares exhibit the locations of HTI hydrophones and inside the boxes are their corresponding number.

By comparing the time of arrival of the sound signal at multiple hydrophones, the two dimensional (or if the hydrophones are arranged appropriately, the three dimensional) position of the tagged fish can be calculated. The algorithm used to determine the three dimensional tag position from the measured time delays minimizes Equation 1:

Equation 1:

$$\sum_{\substack{i=1 \\ j=1 \\ i \neq j}}^4 \left[ (t_i - t_j) - \frac{1}{c} \sqrt{(h_{ix} - F_x)^2 + (h_{iy} - F_y)^2 + (h_{iz} - F_z)^2} - \sqrt{(h_{jx} - F_x)^2 + (h_{jy} - F_y)^2 + (h_{jz} - F_z)^2} \right]^2$$

where:

t = arrival time of a tag signal on a given hydrophone,  
c = speed of sound in water,  
h = hydrophone position in each dimension, and  
F = tag position in each dimension.

Because of the depth in this section of the San Joaquin River, we were not able to acquire 3D data. In order to use the system for two dimensional tracking, the above equation is simplified to include only the X and Y dimensions using time delays from only 3 hydrophones. The HTI AcousticTag data collection and analysis software program allowed us to select two dimensional tag tracking.

Individual tag positions were then assembled in chronological order to form a two dimensional (2D) trace representing the movement of the fish as it passed through the array. This process was done from stored arrival time data (from Raw Acoustic Tag files), and in real time through the acoustic tracking system. The estimated positioning resolution of the acoustic detection system, within the outline of the 4 hydrophones (indicated on Figure 4), was approximately 1 m (S. Johnston, personal communication).

The 4-hydrophone array was adjusted until optimal 2D coverage was achieved. Our goal was to provide the best achievable coverage of the experimental area while maximizing our ability to determine the fate of each fish: 1) Old River, 2) San Joaquin River, 3) predation, 4) unknown or 5) never arrived at the ORB area.

## DIDSON Observations

We deployed a DIDSON camera immediately upstream of the ORB (Figure 5). The camera was placed in the water near the shore and origin point of the BAFF. The camera head was on a rotator and was 75 cm upstream of the ORB. The detection cone was aimed parallel to the BAFF for recording. The images of the DIDSON were recorded for 3 hr prior to and after the BAFF was switched on or off.

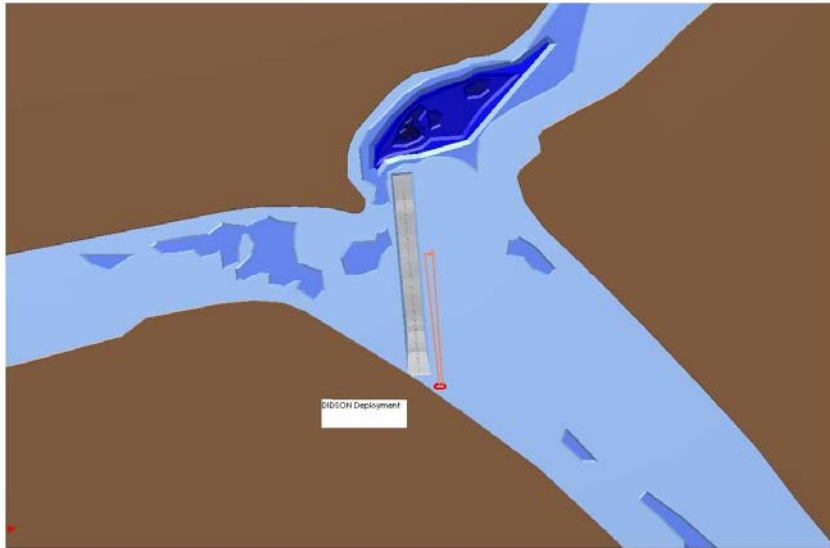

Figure 5. Schematic representation of the DIDSON camera's deployment along the BAFF line in the San Joaquin River immediately upstream of Old River.

#### Vernalis Adaptive Management Program's Experimental Releases

The VAMP team inserted HTI acoustic transmitters in 950 chinook salmon smolts (target size 95-100 mm TL) and released 947 of those alive. These fish were released in seven groups upstream of the ORB at Durham Ferry. There were approximately 135 chinook smolts per release group. Releases at Durham Ferry were made on the following schedule (approximately 17:00 hr = daylight release; approximately 21:00 hr = night release):

Release 1) 4/22/09, 17:05 hr,  
Release 2) 4/25/09, 21:50 hr,

Release 3) 4/29/09, 21:45 hr,  
Release 4) 5/02/09, 17:37 hr,

Release 5) 5/06/09, 21:38 hr,  
Release 6) 5/09/09, 17:39 hr, and

Release 7) 5/13/09, 21:38.

These releases were paired to get three day releases and three night releases; the order of day and night was selected randomly. The one unpaired release, made possible by 947 fish, was at night; the night-time release was selected by a random draw.

### Bio-Acoustic Fish Fence (BAFF) Monitoring Experiment

Each of the VAMP releases comprised one replicate for determining Deterrence Efficiency (D) for the BAFF. We maintained the barrier “On” for a period and the barrier “Off” for a period during each of the seven releases/replicates. If we did not have an On/Off experiment in each release we would have completed N=3 replicates during the day and N=4 replicates at night. Thus, we greatly increased our power by completing On/Off experiments within each release. We wanted to expose 50 percent of the telemetred Chinook smolts to the barrier in operation and 50 percent should not experience the barrier. We estimated how many smolts would comprise 50 percent of those fish passing by the BAFF. For Release 1 we used 47:  $135 \text{ released fish} * 0.7 \text{ (estimated survival from Durham Ferry to the Divergence)} = 94 \text{ smolts should pass by in Release 1}$ . So then 50 percent of that is  $94 * 0.5 = 47$ ; when we reached 47 fish having passed by we turned on or off the BAFF. We also wanted an approximately equal amount of time with barrier On and the barrier Off over the course of the seven replicates. In addition, we wished to have the Barrier On and the Barrier Off over a range of light and tidal conditions. Two full tidal cycles are completed every 25 hours. Twenty-five hours also covers the complete range of light conditions.

Using these parameters the final completed schedule we executed can be found in Table 1 along with the duration of the arrival of the first fish from a release and the last fish from a release.

We established the pattern of starting the experiment Barrier Off (Coded 1) or Barrier On (Coded 2) with random draws of a sequence of two. The random draws were: 1-2, 1-2, 2-1, 1. So then, the seven replicates began in this order: 1) Barrier Off, 2) Barrier On, 3) Barrier Off, 4) Barrier On, 5) Barrier On, 6) Barrier Off, and 7) Barrier Off.

Table 1. Bio-Acoustic Fish Fence (BAFF) operation schedule with durations to first and last tag for each release (Release Number:(Tag nearest time to BAFF – Release Date/Time)). All dates in 2009. ND = No Data.

Release	Date	Time	Barrier State	Duration to	
				1 <sup>st</sup> Tag	Last Tag
1	4/22	17:00 hr	OFF	ND	ND
1	4/23	23:32 hr	ON	1:0 d, 15:55 hr	ND
1	4/24	ALL DAY	ON	ND	ND
1	4/25	21:00 hr	OFF	ND	1:3 d, 4:35 hr
2	4/25	21:50 hr	ON	ND	ND
2	4/26	18:45 hr	OFF	2:1 d, 2:48 hr	ND
2	4/27	19:45 hr	ON	ND	ND
2	4/28	20:45 hr	OFF	ND	ND
3	4/29	21:45 hr	OFF	3:1d, 13:38 hr	2:3 d, 20:42 hr
3	4/30	18:25 hr	ON	ND	ND
3	5/1	19:25 hr	OFF	ND	ND
4	5/2	17:00 hr	ON	4:0 d, 14:45 hr	3:3 d, 8:48 hr
4	5/3	18:50 hr	OFF	ND	ND
4	5/4	20:10 hr	ON	ND	ND
4	5/5	21:10 hr	OFF	ND	ND
5	5/6	21:14 hr	ON	ND	4:4 d, 3:40 hr
5	5/7	15:32 hr	OFF	5:0 d, 13:27 hr	ND
5	5/8	16:37 hr	ON	ND	ND
6	5/9	17:00 hr	OFF	ND	5:3 d, 16:57 hr
6	5/10	16:30 hr	ON	6:0 d, 15:28 hr	ND
6	5/11	ALL DAY	ON	ND	ND
6	5/12	ALL DAY	ON	ND	6:2 d, 13:27 hr
7	5/13	21:00 hr	OFF	ND	ND
7	5/14	16:35 hr	ON	7:0 d, 13:55 hr	ND
7	5/15	17:35 hr	OFF	ND	ND
7	5/16	18:35 hr	ON	ND	7:2 d,13:27 hr
7	5/17	19:35 hr	OFF	ND	ND
7	5/18	20:35 hr	ON	ND	ND
7	5/19	18:00 hr	OFF	ND	ND
7	5/20	19:00 hr	ON	ND	ND
7	5/21	20:00 hr	OFF	ND	ND

#### Non-Physical Barrier Efficiency Calculations

Together, the VAMP team and Reclamation installed a 4-hydrophone array (Figure 4) at the Divergence and one fixed station in the Old River downstream of the Divergence that detected telemetred Chinook smolts passing through the area. We used the 4-hydrophone array to produce 2D traces and to determine the response to the BAFF and the fate of fish.

We determined the response to the ORB by inspecting the 2D trace when the tag approached the BAFF. This was coded as response and had the possible values: 1) undeterred by the BAFF, 2)

deterred by the BAFF, 3) never experienced the BAFF, 4) unknown, and 5) discard. A fish was discarded if it was in the hydrophone array at the time the barrier was switched on or off.

After we determined response to the BAFF, we analyzed the fate of fish. We inspected the 2D trace and compared that to Old River fixed station data to confirm or improve our understanding of the fate. We also reviewed, for every tag, the set of echoes received for each hydrophone. The possible fates of a tag determined in this way were 1) Old River, 2) San Joaquin River, 3) predation, 4) unknown or 5) never arrived at the ORB area.

### Deterrence Efficiency

Deterrence Efficiency may be calculated as

Equation 2:

$$D = E/(E+U)$$

where,

D = Deterrence Efficiency,  
E = number of fish deterred, and  
U = number of fish undeterred.

The numerator is composed of all fish that were deterred, determined by direct inspection of 2D traces. The denominator is composed of all fish making a decision in the immediate vicinity of the BAFF. The “immediate vicinity” was considered to be inside the maximum reactive distance for juvenile salmon, for this BAFF deployment, 2 m or less from the barrier during the day and 10 m or less at night (A. Turnpenny, personal communication and Appendix 1). Grand Deterrence Efficiency was calculated as the total number of fish deterred, summing all seven releases, divided by the sum of all fish for which the response could be determined.

### Protection Efficiency

We used only acoustic-tagged fish that moved through the area and continued downstream to calculate the Protection Efficiency as

Equation 3:

$$P = S/(S+O)$$

where,

P = Protection Efficiency,  
S = number of fish passing down into the San Joaquin River, and  
O = number of fish passing down into the Old River.

The denominator is composed of all fish making a decision and passing into the San Joaquin River or the Old River. Fish that do not pass on through could have been eaten by a predator before encountering the BAFF; so, these fish are not included in the calculation. We determined Protection Efficiency when the BAFF was off and when the BAFF was on for each release. Grand Protection Efficiency was calculated for barrier off and barrier on as the total number of fish going down the San Joaquin River, summing all seven releases, divided by the sum of all fish for which the fate could be determined. All fish that were known to have been the victims of predation were excluded from the calculations of Protection Efficiency.

## Hypothesis Testing

We originally intended to conduct two hypotheses tests:

- 1)  $H_1$ : Deterrence Efficiency when the barrier is on is not equal to Deterrence Efficiency when the barrier is off and
- 2)  $H_2$ : Protection Efficiency when the barrier is on is not equal to Protection Efficiency when the barrier is off.

We found that high predation levels did not allow us to collect sufficient observations of Deterrence Efficiency when the barrier was off. Therefore, we tested Deterrence Efficiency with barrier on against the only available measure of fate with the barrier off: predation efficiency. So, our revised hypothesis 1 is:

$H_{1\text{-adjusted}}$ ) Deterrence Efficiency when the barrier is on is not equal to Protection Efficiency when the barrier is off.

We tested each of these hypotheses,  $H_{1\text{-adjusted}}$  and  $H_2$ , by first evaluating the data for assumptions of Analysis of Variance: 1) independence of observations, 2) homogeneity of variance, and 3) normality. Second, if the data meet these three criteria we conducted a one-way ANOVA: Barrier Off vs. Barrier On. Third, if the data do not meet the assumptions of ANOVA we used a non-parametric technique: Kruskal-Wallis. All analyses were conducted with Statistical Analysis System (SAS, Cary, NC).

## RESULTS

### Predation Before and Near the Old River Barrier

For each release, we calculated the Proportion Never Appearing at ORB (Table 2). In addition to fish that never appeared at the ORB area, we also determined the number of fish that were eaten in the ORB area by inspecting every 2D trace for all 539 fish that appeared in the ORB area. The proportion that appeared and for which there was strong evidence of predation is found in Table 2. In Table 2, we also sum the predation before the ORB area and in the ORB area to find the total estimated predation proportion from Durham Ferry passed the Divergence.

In addition to our quantification of predation in the ORB area, we studied behavior of predators at the site. Our regular observation of the area upstream of Piles 1 and 2 with the DIDSON camera showed interesting behaviors. First, we could identify striped bass with the



DIDSON. These predators were 60-140 cm TL and we could tell they were not sturgeon based on their silhouette. The striped bass would swim in looping patterns pursuing patrolling behavior throughout the ORB area. The striped bass would also swim along the non-physical barrier infrastructure. Another important difference between predators and smolts was their swim speed. Generally, we found the predators swim slower than smolts.

Table 2. Mortality rate of Chinook smolts: 1) between Durham Ferry and the San Joaquin/Old River Divergence, 2) in the Divergence area, and 3) sum of predation (1 and 2) from Durham Ferry passed the Divergence area.

Release	Number Released	Proportion Never Arrived at ORB	Proportion Consumed in ORB area	Total Dead Combined Proportion (before and in ORB area)
1	136	0.478	0.118	0.596
2	136	0.279	0.346	0.625
3	135	0.252	0.400	0.652
4	136	0.485	0.279	0.765
5	136	0.360	0.353	0.713
6	133	0.616	0.135	0.752
7	135	0.385	0.296	0.681

These extremely high predation rates before the ORB ranged from 25.2 to 61.6 percent for each release group of approximately 135 smolts led to low numbers of fish available to evaluate the ORB. In addition, we operated the BAFF about half the time with the barrier off and about half the time with the barrier on leading to lower sample sizes in each division.

#### Deterrence Efficiency

We acquired echoes from every tag that appeared at the Old River Barrier. We attempted to construct a 2D trace (Figure 6) for every one of these tags. From inspection of the 2D traces, we observed a number of tags that were clearly deterred (Figure 7). We enumerated the fish that were deterred like smolt 5674. And, we counted those that were undeterred like tag 6514 (Figure 8).

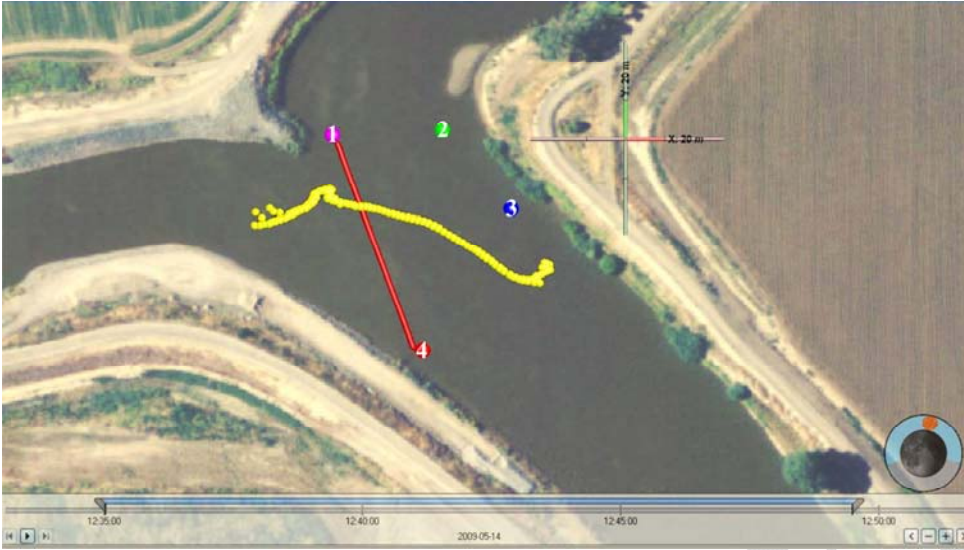

Figure 6. Two dimensional trace of a tagged Chinook smolt at the San Joaquin/Old River Divergence. This photo was taken at high tide; the red line indicates the BAFF location and the colored circles indicate the location and number of the four hydrophones. This 2D trace is Tag 5072 that crossed the BAFF line when the barrier was off on 5/14/09 at approximately 12:41 hr.

The grand Deterrence Efficiency when the barrier is on is 81.4 percent (Table 3). When the barrier is off, the grand Protection Efficiency is 24.5 percent (Table 4). There is a highly significant difference between these two values (Kruskal-Wallis  $X^2 = 9.800$ ,  $p = 0.0017$ ). The BAFF appears to be highly efficient at deterring Chinook smolts.

Table 3. Deterrence Efficiency when the barrier was on and the number of smolts that were deterred or undeterred by the BAFF from their 2D trace.

Release	Barrier	Deterrence Efficiency	Number Deterred	Number Undeterred
1	On	0.9167	11	1
2	On	0.9091	20	2
3	On	0.6190	13	8
4	On	0.9375	15	1
5	On	1.0000	26	0
6	On	0.6000	3	2
7	On	0.6296	17	10
Grand Deterrence Efficiency		0.8139	105	24



Figure 7. Tag 5674 approached the barrier in operation on 5/15/09 at 03:38 hr. The tag exhibits a smolt-like trace: downstream quickly and no predator behavior. This smolt was obviously deterred by the BAFF. This photo was taken at high tide; the green line indicates the BAFF location and the colored circles indicate the location and number of the four hydrophones.



Figure 8. Tag 6514 approached the barrier in operation on 5/15/09 at 00:37 hr. The tag exhibits a smolt-like trace: downstream quickly and no predator behavior. This smolt passed through the BAFF; the 2D trace ends because hydrophone 2, 3, and 4 can't "hear" pings through the bubble curtain. This photo was taken at high tide; the green line indicates the BAFF location and the colored circles indicate the location and number of the hydrophones.

Table 4. Protection Efficiency when Predation is unknown or has not occurred. SJR = San Joaquin River. OR = Old River.

Release	Barrier	Protection Efficiency	Number Down SJR	Number Down OR
1	Off	0.1842	7	31
1	On	0.2500	3	9
2	Off	0.1714	6	29
2	On	0.6250	5	3
3	Off	0.4091	9	13
3	On	0.2500	4	12
4	Off	0.1875	3	13
4	On	0.1667	1	5
5	Off	0.1613	5	26
5	On	0.7143	5	2
6	Off	0.3333	9	18
6	On	0.2000	1	4
7	Off	0.3684	7	12
7	On	0.1429	2	12
Grand Efficiency, Barrier Off		0.2447	46	142
Grand Efficiency, Barrier On		0.3088	21	47

#### PROTECTION EFFICIENCY

Holbrook et al. (2009) found that in 2008 only 22-33% of fish used the San Joaquin route. We found a similar phenomenon: when the barrier is off the grand Protection Efficiency is 24.5 percent. The grand Protection Efficiency is 30.8 percent when the barrier is on. There is no statistically significant difference between the Protection Efficiency samples for barrier off and barrier on (Kruskal-Wallis  $X^2 = 0.1023$ ,  $p=0.7491$ ). The predation level is so high that the influence of the highly efficient BAFF is not statistically significant for Protection Efficiency barrier off vs. on. The suppression of this influence can be demonstrated by observing the results for Tag 5344. In Figure 9, the tag exhibits smolt-like behavior down to contact with the BAFF where the smolt is deterred. So, the entry for Tag 5344's response is "deterred."



Figure 9. Tag 5344 approaches the operating BAFF on 4/30/09 at 18:46 hr. Upon this fish's first approach to the BAFF, it is deterred. This photo was taken at high tide; the green line indicates the BAFF's physical location and the colored circles indicate the location and number of the four hydrophones. With stream velocity, the bubble barrier is carried downstream of this green line.



Figure 10. After 5344 is deterred it moves along the BAFF and eventually demonstrates unmistakably predator-like behavior. This photo was taken at high tide; the green line indicates the BAFF location and the colored circles indicate the location and number of the four hydrophones.

In Figure 10, the smolt with Tag 5344 clearly has been eaten and is now in a striped bass. The striped bass behavior pattern is the commonly observed looping and patrolling behavior we observed routinely with the DIDSON. So, the response of this fish to the BAFF is deterred but the fate of this fish is “predation.” Thus, 5344 contributes to the Deterrence Efficiency but not the Protection Efficiency. A great number of tags exhibited this behavior: deterred then eaten and never proceeding down the San Joaquin or Old Rivers. This is why we found such a high Deterrence Efficiency, 81.4 percent, but a low Protection Efficiency with the barrier on: 30.8 percent.

## DISCUSSION

A highly statistically significant proportion of Chinook salmon was deterred by the BAFF. The deterrence rate was 81.4%. We compared the Deterrence Efficiency with the BAFF on to the Protection Efficiency with the BAFF off. We chose to do this because there was only sufficient sample size for a hypothesis test using the Protection Efficiency.

When the BAFF was on, the Protection Efficiency for each release showed more fish moving down the Old River for five of the seven releases. Releases 2 and 5 were the only exceptions and the total number of fish in these two releases is 8 and 7 fish respectively. The most likely explanation for higher numbers going down Old River is higher predation rate in the San Joaquin River downstream of the BAFF. Our 2D traces support this explanation; many smolts that were deterred by the BAFF were eaten in the vicinity of the scour hole.

The predation rate was so high in fact that the Protection Efficiency was not statistically different between barrier off and barrier on. The data suggest that much of the gains accomplished by the BAFF’s determent of smolts is offset by the predators in the scour hole. We recommend that if the BAFF is installed in the future that predator relocation be employed in the ORB area. For example, striped bass and largemouth bass could be moved from the Divergence to San Luis Reservoir. Failure to do so could lead to a similar situation to that we observed in 2009. That is, the highly efficient BAFF’s deterrence may be offset by the heavy predation in the scour hole.

It is possible that the high 2009 predation rates we observed were a function of the dry year in the San Joaquin River. Smolts and predators might have been concentrated into a smaller volume of water than in average or wet years. Such a concentration could result in higher encounter rates between predators and smolts leading to an increased predation rate.

We also observed differences in Protection Efficiency with the BAFF off depending on the release (Table 4), tide, and discharge. Protection Efficiency was as low as 0.1429 and as high as 0.4091. We think that at least some of these differences may result from differences in flow fields that change with the tide and subsequent discharge (Figures 11 and 12).

Why does the barrier work for Chinook salmon? It is our opinion that the sound deterred the fish and the bubble curtain contained the sound. The strobe light enabled the fish to identify the source of the sound. The fish saw the barrier because of the strobe lights and they heard the sound as they approached the BAFF. The risk of passing through the barrier to an uncertain future was greater than the risk of swimming away and passing into a different uncertain future but avoiding the source of that sound.

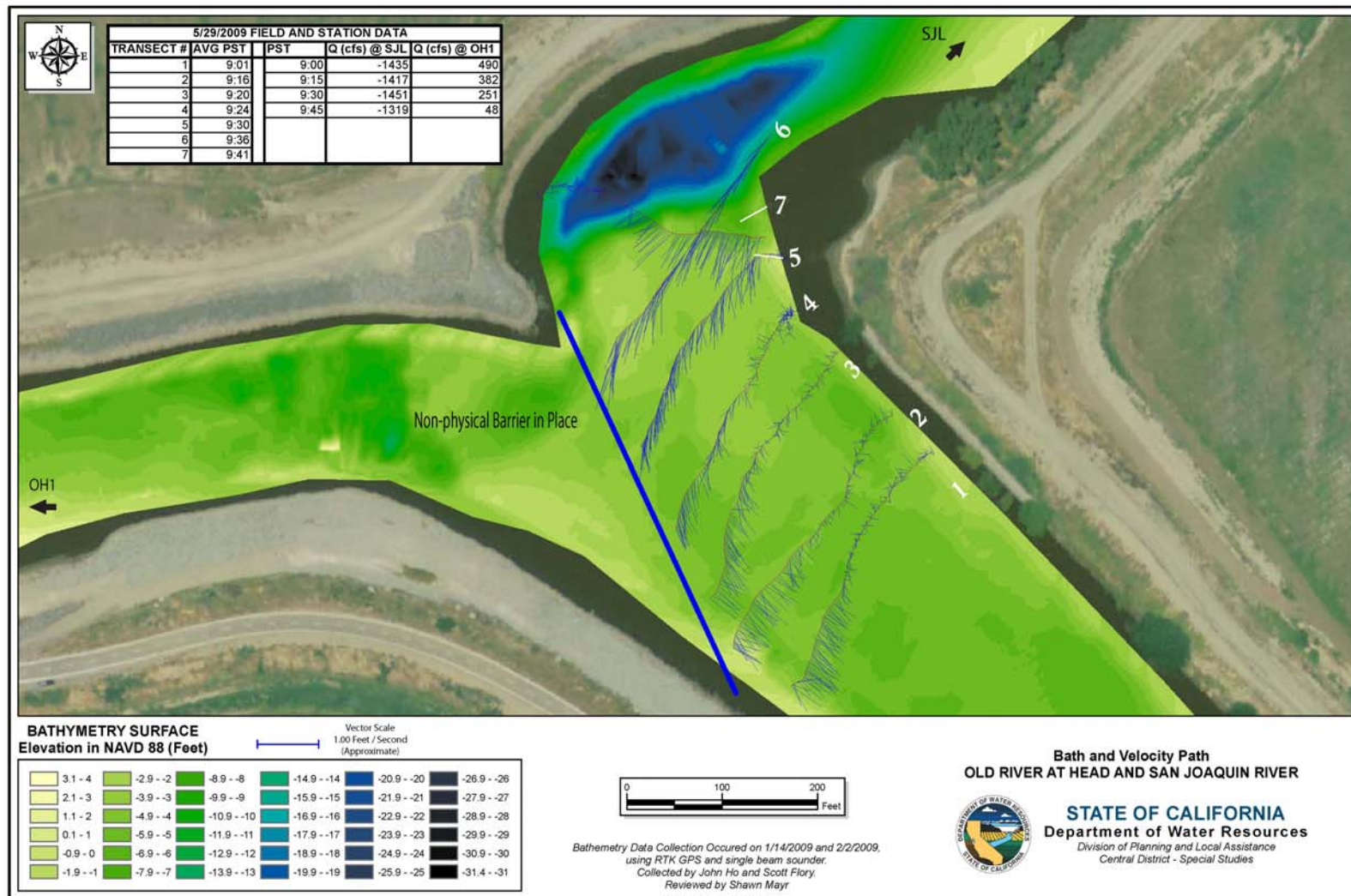

Figure 11. Velocity field at the Divergence of the San Joaquin River and Old River with a negative discharge at the San Joaquin/Lathop (SJL) gauge. Data and figure supplied by Shawn Mayr, DWR.

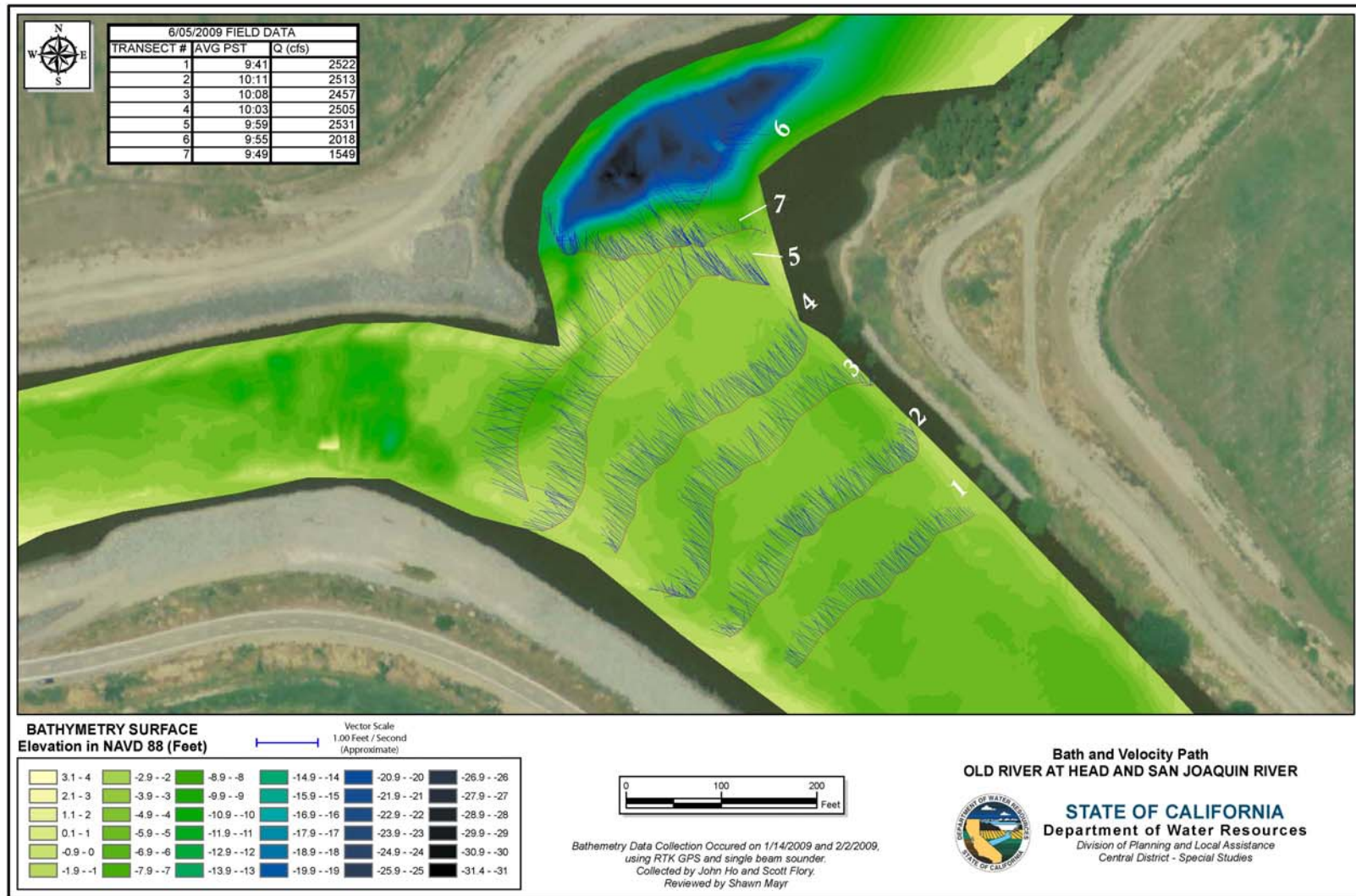

Figure 12. Velocity field at the Divergence of the San Joaquin River and Old River with a positive discharge. Data and figure supplied by Shawn Mayr, DWR.



## Literature Cited and Some Related Literature

- Bowen, M.D., L. Hanna, R. Bark, V. Maisonneuve, and S. Hiebert. 2008. Non-physical barrier evaluation, Physical Configuration I. US Department of the Interior, Bureau of Reclamation. Technical Memorandum. Technical Service Center. Denver, CO, US.
- Holbrook, C.M., R.W. Perry, and N.S. Adams. 2009. Distribution and joint fish-tag survival of juvenile Chinook salmon migrating through the Sacramento-San Joaquin River Delta, 2008. US Department of the Interior, US Geological Survey. Biological Resources Discipline Report to San Joaquin River Group Authority. Cook, WA, US.
- Lemasson, B.H., J.W. Haefner, and M.D. Bowen. 2008. The effect of avoidance behavior on predicting fish passage rates through water diversion structures. *Ecological Modelling* 219: 178-188.
- Kimmerer, Wim J. 2008. Losses of Sacramento River Chinook Salmon and Delta Smelt (*Hypomesus transpacificus*) to Entrainment in Water Diversions in the Sacramento-San Joaquin Delta. *San Francisco Estuary and Watershed Science*. Vol. 6, Issue 2 (June), Article 2.
- San Joaquin River Group Authority. 2008. 2007 Annual Technical Report: On implementation and monitoring of the San Joaquin River Agreement and Vernalis Adaptive Management Plan. San Joaquin River Group Authority. Davis, CA, US.  
<http://www.sjrg.org/technicalreport/default.htm>
- Sokal, R.R. and F.J. Rohlf. 1981. *Biometry*. 2<sup>nd</sup> Edition. W.H. Freeman and Company. San Francisco, CA, US.
- Taylor R.M., Pegg M.A., & Chick J.H. 2005. Response of Bighead Carp to a Bioacoustic Behavioural Fish Guidance System. *Fisheries Management and Ecology* 12: 283-286.
- Welton J.S., Beaumont W.R.C. & Ladle M. 2002. The efficacy of Acoustic bubble screens in deflecting Atlantic Salmon (*salmo salar L.*) smolts in the River From, U.K. *Fisheries Management and Ecology* 9: 11-18.

Appendix 1. Sound pressure levels measured along the non-physical barrier. The ambient readings with barrier off were made at Pile 1: 98-104 dB re 1 $\mu$ Pa.

Measuring Position		Sound Measurements	
		dB re 1 $\mu$ Pa, Barrier On	
Pile 1 Upstream	Waypoint	Upstream	Downstream
0 m	647258/4185772	144	
1 m	647260/4185773	142	144
3 m	647260/4185775	104	104
		dB re 1 $\mu$ Pa, Barrier On	
Pile 2 Upstream	Waypoint	Upstream	Downstream
0 m	647250/4185801	102	
1 m	647250/4185802	100	102
3 m	647249/4185804	98	98
		dB re 1 $\mu$ Pa, Barrier On	
Pile 3 Upstream	Waypoint	Upstream	Downstream
0 m	647235/4185847	90	
1 m	647235/4185846	123	112
3 m	647237/4185844	119	118
		dB re 1 $\mu$ Pa, Barrier On	
Pile 4 Upstream	Waypoint	Upstream	Downstream
0 m	647222/4185876	151	
1 m	647223/4185876	127	138
3 m	647225/4185876	86	92