

CALIFORNIA REGIONAL WATER QUALITY CONTROL BOARD
CENTRAL VALLEY REGION

Fresno Office 1685 "E" St. Fresno, CA 93706-2007	Sacramento Office (Main) 11020 Sun Center Dr. #200 Rancho Cordova, CA 95670-6114	Redding Office 364 Knollcrest Dr. #205 Redding, CA 96002
--	---	--

[Regional Board Website](https://www.waterboards.ca.gov/centralvalley) (<https://www.waterboards.ca.gov/centralvalley>)

**WASTE DISCHARGE REQUIREMENTS ORDER R5-2024-0016 FOR
THE PRODUCTION OF RECYCLED WATER**



ORDER INFORMATION

Order Type(s):	Waste Discharge Requirements (WDRs)
Status:	Adopted
Program:	Non-15 Discharges to Land
Region 5 Office:	Fresno
Discharger(s):	Tuolumne Utilities District
Facility:	Sonora Regional Wastewater Treatment Facility
Address:	1400 Southgate Drive, Sonora
County:	Tuolumne County
Parcel Nos.:	056-590-005
CIWQS Place ID:	257763
Prior Order:	94-192

CERTIFICATION

I, PATRICK PULUPA, Executive Officer, hereby certify that the following is a full, true, and correct copy of the order adopted by the California Regional Water Quality Control Board, Central Valley Region, on 19 April 2024.

PATRICK PULUPA,
Executive Officer

Table of Contents

TABLE INDEX	iii
GLOSSARY	iv
FINDINGS	1
Introduction.....	1
Regulatory History	1
Facility and Discharges	3
Wastewater Collection System	11
Industrial Pretreatment Considerations	12
Water Recycling Considerations.....	13
Site-Specific Conditions.....	14
Statutory Authority	19
Basin Plan Implementation.....	20
California Environmental Quality Act	23
Other Regulatory Considerations	24
Scope of Order	27
Procedural Matters	27
REQUIREMENTS	28
A. Standard Provisions	28
B. Discharge Prohibitions	28
C. Effluent Flow Limitations	29
D. Effluent Limitations.....	29
E. Salinity Action Level.....	30
F. Discharge Specifications.....	30
G. Groundwater Limitations	33
H. Solids Disposal Specifications.....	34
I. Provisions.....	35
ENFORCEMENT	38
ADMINISTRATIVE REVIEW	39
ATTACHMENT A—SITE LOCATION MAP	A-1

ATTACHMENT B—PROPOSED SITE PLAN	B-1
ATTACHMENT C—PROPOSED FLOW DIAGRAM	C-1
INFORMATION SHEET	IS-1

TABLE INDEX

Table 1 – Effluent Flows (mgd)	5
Table 2 – Historic Monthly Average Effluent Data	5
Table 3 – Effluent Characterization Data.....	6
Table 4 – Quartz Reservoir Annual Averages (mg/L).....	6
Table 5 – Effluent Total Coliform Organisms (MPN/100 mL)	7
Table 6 – Proposed Tertiary Effluent Quality.....	8
Table 7 – Design Influent Flow Rates.....	8
Table 8 – Extended Aeration Activated Sludge Basis Design	9
Table 9 – Chlorine Contact Basins Design.....	10
Table 10 – Source Water Quality	15
Table 11—Reclamation System Groundwater Monitoring Network	16
Table 12 – TUD Monitoring Wells Near Quartz Reservoir.....	17
Table 13 – TUD Monitoring Wells Near Rosasco Use Area	18
Table 14 – TUD Monitoring Wells Near Gardella Use Area	18
Table 15 – Regional Groundwater Results.....	19
Table 16—Effluent Flow Limitations	29
Table 17—Tertiary Treated Effluent Limitations	29

GLOSSARY

Antidegradation Policy.....	Statement of Policy with Respect to Maintaining High Quality Waters in California, State Water Board Resolution 68-16
ADWF.....	Average Dry Weather Flow
APN(s).....	Assessor Parcel Number(s)
Basin Plan.....	Water Quality Control Plan for [BASIN]
BOD.....	Biochemical Oxygen Demand (general term)
BOD _[5]	[Five-Day] Biochemical Oxygen Demand at 20°Celsius (specific analysis)
BPTC.....	Best Practicable Treatment or Control
CDO.....	Cease and Desist Order
CEQA Guidelines.....	California Code of Regulations, Title 14, section 15000 et seq.
COC[s].....	Constituent[s] of Concern
CV-SALTS.....	Central Valley Salinity Alternatives for Long-Term Sustainability
DO.....	Dissolved Oxygen
DWR.....	California Department of Water Resources
EC.....	Electrical Conductivity
FEMA.....	Federal Emergency Management Agency
IPP.....	Industrial Pretreatment Program
µg/L.....	Micrograms per Liter
µmhos/cm.....	Micromhos per Centimeter
MG[D].....	Million Gallons [per Day]
mg/L.....	Milligrams per Liter
MRP.....	Monitoring and Reporting Program
MW.....	Monitoring Well
MCL.....	Maximum Contaminant Level per Title 22
N.....	Nitrogen
ND.....	Non-Detect
RAS.....	Returned Activated Sludge

Tuolumne Utilities District

Sonora Regional Wastewater Treatment Facility

Tuolumne County

GLOSSARY

Recycled Water Policy	Policy for Water Quality Control for Recycled Water, State Water Board Resolution 2009-0011, as amended per Resolutions 2013-0003 and 2018-0057
R[O]WD	Report of Waste Discharge
RCRA	Resource Conservation and Recovery Act
SPRRs	Standard Provisions and Reporting Requirements
TDS	Total Dissolved Solids
Title 22	California Code of Regulations, Title 22
Title 23	California Code of Regulations, Title 23
Title 27	California Code of Regulations, Title 27
TKN	Total Kjeldahl Nitrogen
TSS	Total Suspended Solids
TUD	Tuolumne Utilities District
Unified Guidance	Statistical Analysis of Groundwater Monitoring Data at RCRA Facilities, Unified Guidance (USEPA, 2009)
U.S. EPA	United States Environmental Protection Agency
Use Area	Recycled Water Use Area
VOC[s]	Volatile Organic Compound[s]
WAS	Waste Activated Sludge
WDRs	Waste Discharge Requirements
WQO[s]	Water Quality Objective[s]
WRRs	Water Reclamation Requirements
WWTF	Wastewater Treatment Facility

FINDINGS

The Central Valley Regional Water Quality Control Board (Central Valley Water Board) hereby finds as follows:

Introduction

1. Tuolumne Utilities District (TUD or Discharger) owns and operates the Sonora Regional Wastewater Treatment Facility (WWTF) (the Facility), which is located approximately 1.3 miles south of Sonora in Tuolumne County, Section 1, Township 1N, Range 14E, Mount Diablo Base and Meridian (MDB&M). The Facility's location is depicted on the Site Location Map in **Attachment A**.
2. The Facility is located on Tuolumne County Assessor Parcel Numbers (APN) 059-590-005.
3. As the Facility's owner and operator, the Discharger is responsible for compliance with the waste discharge requirements (WDRs) prescribed in this Order.
4. The following materials are attached and incorporated as part of this Order:
 - a. ATTACHMENT A—SITE LOCATION MAP
 - b. ATTACHMENT B—SITE PLAN
 - c. ATTACHMENT C—FLOW DIAGRAM
 - d. Standard Provisions and Reporting Requirements for Waste Discharge Requirements (1 March 1991) (SPRRs)
 - e. Information Sheet
5. This Order regulates the treatment of domestic wastewater at the Facility. The offsite reclamation of the Facility's treated effluent is regulated by a separate order. See Finding 48 for more information.
6. Also attached is **Monitoring and Reporting Program Order R5-2024-0016** (MRP), which requires monitoring and reporting for discharges regulated under these WDRs. The Discharger shall comply with the MRP, and subsequent revisions thereto, as ordered by the Central Valley Water Board.

Regulatory History

7. WDRs and MRP Orders 94-192 were adopted by the Central Valley Water Board on 24 June 1994. WDRs Order 94-192 currently regulates the Facility and

authorizes a monthly average dry weather discharge flow of up to 2.6 million gallons per day (mgd) of disinfected secondary wastewater to Quartz Reservoir for summer use as irrigation water. Water Reclamation Requirements (WRRs) Order 94-200 was also issued to the Discharger for regulation of its reclamation of wastewater for use by private landowners for irrigation of crops and pastureland. On 5 December 2002, the Central Valley Water Board adopted WDRs and Master Reclamation Permit Order R5-2002-0202, which superseded Order 94-200. Order R5-2002-0202 prescribes requirements for the discharge of reclaimed water to Quartz Reservoir and to recycled water use areas (approximately 630 acres).

8. This Order rescinds and replaces WDRs Order 94-192 and provides updated WDRs for the Facility to ensure the discharge is consistent with state and regional water quality plans and policies, and to reflect the upgrades to the Facility. WDRs and Master Reclamation Permit R5-2002-0202 will remain in effect until the Discharger has been enrolled in the State Water Board Order WQ 2016-0068-DDW *Water Reclamation Requirements for Recycled Water Use* (Reclamation General Order). Once the Discharger obtains coverage under the Reclamation General Order, WDRs and Master Reclamation Permit Order R5-2002-0202 will be rescinded under a separate order.

September 2022 RWD and Revisions

9. On 27 June 2019, representatives from the Central Valley Water Board, TUD, and Pacific Advanced Civil Engineering (PACE) met to discuss key regulatory and design elements of planned upgrades to the Facility. On 22 September 2022, PACE, on behalf of the Discharger, submitted a Report of Waste Discharge (RWD) to upgrade the Facility to a tertiary treatment recycling facility. On 21 October 2022, Central Valley Water Board staff (Staff) sent a letter to TUD explaining that the September 2022 RWD was incomplete due to concerns regarding the requested flow limitations, water balance, and antidegradation analysis.
10. On 8 March 2023, Robertson-Bryan Inc. (RBI), on behalf of the Discharger, submitted two technical memoranda in response to Staff's October 2022 letter: (1) *Information Supplementing the Sonora Regional Wastewater Treatment Facility (WWTF) Report of Waste Discharge (RWD)*, and (2) *Tuolumne Utilities District Sonora Regional Wastewater Treatment Facility Water Balance Technical Review and Application* (March 2023 Modified Water Balance). The March 2023 Modified Water Balance showed sufficient disposal capacity for 2.0 mgd, with 855 acres of disposal area (use areas). Staff expressed concern that the 855 acres of proposed use areas included the 252-acre Teleli Golf Course, which is not currently available as a use area because a pipeline has not yet been constructed connecting the Facility to the Golf Course. In response, the Discharger submitted a revised water balance in June 2023 showing the

Facility's current storage and disposal capacity of 1.84 mgd with the current Land Application Areas (LAAs) (603 acres), which excludes the 252 acres of the Teleli Golf Course. The March 2023 Modified Water Balance noted that 683 acres (80 additional acres) is required to store and dispose an average dry weather flow (ADWF) of 2.0 mgd during the 100-year rainfall scenario.

11. On 30 August 2023, RBI, on behalf of the Discharger, submitted a report titled *Antidegradation and Background Groundwater Analysis Report for the Tuolumne Utilities District Quartz Reservoir and Use Areas (2023 Antidegradation Analysis Report)*. The 2023 Antidegradation Analysis Report evaluated the Facility's discharge impact on underlying groundwater and compliance with State Water Resources Control Board (State Water Board) Resolution 68-16, Statement of Policy with Respect to Maintaining High Quality Waters in California.

Cease and Desist Order (CDO) R5-2002-0203

12. On 5 December 2002, the Central Valley Water Board adopted CDO Order R5-2002-0203, requiring TUD to cease and desist from discharging contrary to WDRs and Master Reclamation Permit Order R5-2002-0202 and its predecessor, WRRs Order 94-200. The CDO was based on several chronic violations of these Orders observed by Staff between 2000-2002, including discharge of wastewater into surface water drainage courses, onto unpermitted lands, and onto roadways accessible to the public. The CDO required TUD to bring all end-use areas into compliance with Order R5-2002-0202 and to develop and implement long-term facility upgrades to ensure ongoing, future compliance. The Discharger complied with the requirements of the CDO and, on 13 September 2013, TUD submitted an updated water balance to Central Valley Water Board staff demonstrating its effluent storage and disposal system could contain all wastewater on land in compliance with WDR R5-2002-0202. Therefore, the requirements of CDO R5-2002-0203 have been satisfied and revocation of the CDO is appropriate.

Facility and Discharges

Service Area

13. TUD is a water and wastewater utility service that provides sewer services to nearly 13,000 residents in the surrounding areas of Twain Harte, Sonora, Mono Village, Rancho Sonora Estates, Columbia, Willow Springs, Crystal Falls, and Ranchos Poquitos in Tuolumne County. The Facility receives wastewater from approximately 6,140 connections, including residential and commercial sources, as well as hauled in septage.
14. According to the United States Census Bureau, the median household income (MHI) in Tuolumne County from 2017 to 2021 was \$66,800. During the same period, the MHI in the State of California was \$81,600.

15. According to the RWD, TUD receives approximately 95 percent of its water supply from the South Fork Stanislaus River, where water is diverted just below Lyons Reservoir at an elevation of approximately 4,200 feet. The remaining 5 percent of water supply comes from drinking water wells. The water then enters TUD's ditch/canal system and is delivered to several surface water treatment plants owned and operated by TUD. The service area does not contain a groundwater basin, and wells within the area have limited storage due to fractured formations. In addition, many wells in the area experience elevated levels of iron and manganese.

Existing Facility and Reclamation System

16. The Facility was originally constructed in 1974 and featured mechanically cleaned screens, grit removal basins, primary clarification, two rock media trickling filters (later upgraded to plastic media), secondary clarification, polishing ponds, and a chlorine contact basin. The original treatment process produced secondary disinfected-23 recycled water that was beneficially reused as irrigation water on non-food crops.
17. Treated effluent from the Facility is transported via a distribution pipeline to Quartz Reservoir for storage prior to delivery to several end users regulated by WDRs and Master Reclamation Permit Order R5-2002-0202. A small number of end users can be supplied by turnouts along the line prior to delivery to Quartz Reservoir.
18. Jamestown Sanitary District (JSD) owns and operates a WWTF (JSD WWTF) permitted under WDRs Order R5-2021-0046, which allows discharges up to 0.23 mgd ADWF of disinfected secondary effluent to TUD's Reclamation System. Discharge to TUD's Reclamation System occurs under the *Agreement between Jamestown Sanitary District and Tuolumne Utilities District Transfer in Connection with Wastewater Treatment Facilities Improvements Project No. C-06-8000-210* (JSD-TUD Agreement). The JSD WWTF was recently upgraded so that it could treat flows of up to 0.144 mgd to disinfected tertiary standards.
19. According to WDRs and Master Reclamation Permit Order R5-2002-0202, approximately one-half of the area below the normal maximum water surface elevation of Quartz Reservoir contains a one-quarter inch asphalt membrane liner. The leakage rate of the intact asphalt liner is estimated to be 129,000 to 259,000 gallons per year.
20. Monthly average effluent flows from 2018 through 2022 range from 0.93 mgd to 2.35 mgd as shown in **Table 1** below.

Table 1 – Effluent Flows (mgd)

Month	2018	2019	2020	2021	2022
January	1.24	1.40	1.39	1.82	1.36
February	1.12	2.16	1.30	1.86	1.08
March	1.82	2.35	1.52	0.93	1.20
April	1.48	1.41	1.39	1.10	1.33
May	1.12	1.47	1.18	1.12	1.49
June	1.05	1.32	1.12	1.00	1.16
July	1.08	1.20	1.19	1.07	1.14
August	1.12	1.09	1.29	1.26	1.66
September	1.08	1.11	1.14	1.23	1.18
October	1.03	1.10	1.18	1.27	1.07
November	1.17	1.32	1.13	1.20	1.05
December	1.27	1.67	1.58	1.78	1.56
Annual Average Flow (mgd)	1.22	1.47	1.28	1.30	1.27
Total Annual Volume (MG)	443.76	533.63	470.53	474.81	464.77

21. Historic effluent monitoring data collected from self-monitoring reports provided by the Discharger for select constituents/parameters is summarized in **Table 2** below. The averages for 2018 through 2022 are listed with the range shown in parentheses below.

Table 2 – Historic Monthly Average Effluent Data

Date	Monthly Average Effluent BOD (mg/L)	Monthly Average Effluent TSS (mg/L)	Monthly Average Effluent EC (µmhos/cm)
2018	23.3 (17.4-31.2)	20.3 (7.0-43.5)	636 (554-684)
2019	20.9 (11.5-39.4)	23.3 (9.0-57.3)	612 (492-740)
2020	17.5 (12.4-25.0)	33.2 (9.5-140)	633 (598-685)
2021	19.4 (14.6-23.5)	28.8 (10.2-95.4)	635 (569-715)
2022	69.6 (12.5-107.2)	29.0 (6.5-109.3)	621 (575-676)

22. Additional effluent characterization data was submitted in the 2023 Antidegradation Analysis Report. The data from the 2023 Antidegradation Analysis Report is presented in **Table 3** below. Effluent data was collected between August 2019 and July 2022. The number of samples collected for each parameter/constituent is presented below.

Table 3 – Effluent Characterization Data

Parameter/Constituent	Units	# of Samples	Minimum	Average	Maximum
Total Dissolved Solids	mg/L	1,095	169	305	694
TKN as N	mg/L	1	23.7	23.7	23.7
Ammonia as N	mg/L	1	21.6	21.6	21.6
Nitrate as N	mg/L	4	0.11	2.0	3.7
pH	Std. Units	1,094	6.5	7.0	8.4
Total Alkalinity as CaCO ₃	mg/L	3	144	172	218
Hardness CaCO ₃	mg/L	4	74	78	86
Bicarbonate Alkalinity CaCO ₃	mg/L	3	144	172	218
Carbonate Alkalinity CaCO ₃	mg/L	3	ND	ND	ND
Chloride	mg/L	15	56.2	66.3	73.9
Sodium	mg/L	15	52.2	59.8	72.1
Sulfate	mg/L	3	17	17.7	18
Aluminum (Total)	mg/L	1	0.25	0.25	0.25
Arsenic (Total)	mg/L	1	ND	ND	ND
Copper (Total)	mg/L	1	0.029	0.029	0.029
Iron (Total)	mg/L	3	0.53	0.55	0.57
Iron (Dissolved)	mg/L	3	0.2	0.26	0.35
Manganese (Total)	mg/L	3	0.052	0.059	0.063
Manganese (Dissolved)	mg/L	3	0.039	0.042	0.045

23. Effluent quality of the combined treated wastewater from Sonora WWTF and Jamestown WWTF stored in Quartz Reservoir is shown below in **Table 4**.

Table 4 – Quartz Reservoir Annual Averages (mg/L)

Parameters	2019	2020	2021	3-yr Average
Nitrate as NO ₃	1.3	1.7	2.3	1.7
Nitrite Nitrogen	0.6	0.6	1.3	0.9
Ammonia as Nitrogen	12.1	15.1	11.9	12.7
Hardness as CaCO ₃	73.6	102.1	75.6	83.5
Total Dissolved Solids	353.3	303.3	324.1	326.9

24. Certain components of the current Facility were reportedly at the end of their service lives and were not capable of handling the loading coming into the Facility. Therefore, the Facility was struggling to comply with applicable water quality limitations, specifically for total coliform (effluent total coliform organisms data is shown below in **Table 5**). To correct this issue, TUD upgraded and

continues to upgrade the Facility. Facility upgrades commenced around December 2021, startup initiated around December 2023, and additional upgrades to the solids digesters are currently underway. As depicted in **Table 5**, the Facility experienced temporary lapses in performance for treatment of total coliform organisms due to the implementation of upgrades necessary for long-term improvements.

Table 5 – Effluent Total Coliform Organisms (MPN/100 mL)

Month	2018	2019	2020	2021	2022
January	13	2	4	4	4
February	30	13	22	11	34.5
March	50	13	23	22	27.9
April	13	30	8	4	13.5
May	23	22	22	50	3.6
June	30	17	21	23	10.9
July	30	70	240	30	20.1
August	70	130	50	128	472.4
September	500	11	30	185	437.2
October	30	80	13	13	337.2
November	2	21	15	80	27.0
December	2	17	15	30	272.8
Average	66	36	39	48	138.4

25. As previously discussed, TUD upgraded the Facility to provide disinfected tertiary recycled water for expanded reuse applications within the region. The Facility upgrades included the following: a new headworks, lining Pond A (former emergency storage basin) with a 45-mil reinforced polypropylene liner to act as an emergency storage basin, adding a north process station to combine and equalize influent flows from different service areas, adding two lined extended aeration activated sludge basins (with an underdrain and leak detection system), adding two concrete 65-foot diameter secondary clarifiers, adding a south process station to process effluent from the extended aeration activated sludge basins and sludge and scum from the activated sludge and secondary clarification treatment process, adding two media disk filters to achieve tertiary filtration, adding two chlorine contact basins, four digester thickeners, and converting the anaerobic digesters to aerobic digestion. A Facility map is included as **Attachment B**.

26. As part of the construction process for the new facilities, the Discharger cleaned out and removed sludge from the former polishing ponds before excavating an 18-inch-thick clay layer, with a total volume of approximately 11,000 cubic yards, from beneath the former ponds. A volatile organic compound (VOC) test of the removed layer showed that no VOCs were present. The excavated clay was mixed with soil and used as backfill around the project site.

27. The Facility’s upgrades converted the existing treatment process from primary clarifiers, trickling filters, secondary clarifiers, aerated polishing ponds, and chlorine disinfection to an extended aeration activated sludge process consisting of two lined basins followed by secondary clarification, filtration, and chlorine disinfection. The upgraded treatment process consists of the following facilities: influent manhole flow measurement, fine screening, grit removal, emergency storage, extended aeration activated sludge basins for biological treatment, one emergency storage basin, disk filters, and chlorine disinfection.
28. A flow diagram of the upgraded Facility is included as **Attachment C**. With the added nitrification and denitrification processes, the Facility is designed to reduce the average total nitrogen concentrations in the effluent to below 10 mg/L. TUD proposes to use the tertiary-treated disinfected recycled water at the end use reclamation areas covered under WDRs and Master Reclamation Permit Order R5-2002-0202 or, in the future, under the Reclamation General Order. The RWD included proposed disinfected tertiary effluent quality that is summarized in **Table 6** below.

Table 6 – Proposed Tertiary Effluent Quality

Parameters	Units	Effluent
BOD	mg/L	< 10
TSS	mg/L	< 10
Total Nitrogen	mg/L	< 10
Nitrate (as N)	mg/L	< 10
TDS	mg/L	< 700
pH	Standard	6.5 – 8.5
Total Coliform	MPN/100 mL	< 2.2

29. WDRs Order 94-192 included a monthly average dry weather discharge flow of 2.6 mgd. The upgraded Facility’s design influent flow rates are presented in Table 7 below. The ESB allows the Facility to receive flows in excess of the design criteria for the subsequent treatment.

Table 7 – Design Influent Flow Rates

Parameters	Units	Design Flows
Average Dry Weather Flow	mgd	2.0
Maximum Daily Flow	mgd	5.0
Peak Hour Wet Weather Flow	mgd	10.0

30. The headworks system has a design capacity of 10 mgd. The headworks include two parallel process trains, each consisting of six-millimeter fine screens and a grit-removal vortex placed within the concrete channel structure. As part of the upgrades, the screening includes both a washer compactor and grit classifier. The fine screens are mechanically cleaned using an in-channel rake. A washer

compactor processes screenings prior to being transported to a landfill for disposal. Accumulated grit is separated in the classifier using a recessed impeller pump and then separated in the classifier using a screw conveyor for dewatering. The separated grit is disposed of via landfill.

31. Two extended aeration activated sludge basins were constructed to provide secondary treatment at the Facility. Both extended aeration activated sludge basins are lined with a 45-mil reinforced polypropylene geotextile liner and an under drain and leak detection system was installed under the liners. The extended aeration sludge process utilizes a longer hydraulic retention time (HRT) of 50 hours to provide a stable treatment process that can handle fluctuating loads and flows with minimal operation and without pre- and post-equalization. Aerobic and anoxic conditions within the extended aeration activated sludge basins provide biological treatment of the raw screened influent. A portion of the settled floc from the secondary clarifiers is returned to the beginning of the secondary treatment process as returned activated sludge (RAS) to assist with nitrification and denitrification within the basins. Another portion of the settled floc is removed from the clarifiers as waste activated sludge (WAS). The newly constructed south process station facilitates RAS and WAS pumping and scum removal.

Table 8 – Extended Aeration Activated Sludge Basis Design

Parameters	Design Criteria
Number of Basins	2
Capacity per Basin	>2.5 mgd
Basin Dimensions (L x W x D)	108 ft x 168 ft x 14-16 ft
Volume Per Basin	2.2 – 2.6 million gallons

32. The emergency storage basin provides three million gallons of emergency storage during extreme wet weather conditions and during emergency shutdown or failure of the Facility. TUD will minimize use of the emergency storage basin for inflow storage because the extended aeration activated sludge basins were designed with several inches of operating freeboard to accommodate most wet weather flows. In addition, filter backwash will discharge under normal operation to an overflow weir box connected to the emergency storage basin and intra-facility pump station. Filter backwash consists of secondary-treated effluent from the clarifiers. Backwash will travel directly along the downgradient slope of the emergency storage basin in a shallow stream to drain connected to the intra-facility pump station. The emergency storage basin is lined with a 45-mil reinforced polypropylene geotextile liner. Overflow at the headworks is provided to an overflow box, which is connected to the emergency storage basin. The extended aeration activated sludge basins also overflow to the emergency storage basin at the high-water level, at which time the emergency storage basin

will be evacuated using submersible non-clog pumps back to the lift station for screening/grit removal for reprocessing.

33. Two new 65-foot diameter secondary clarifiers were constructed to remove suspended solids and discharge clarified water to the filtration and chlorine contact disinfection units prior to disposal into Quartz Reservoir. Effluent from the secondary clarifier will be lifted to the pre-filter channel by the filter feed pumps. If turbidity is high either upstream or downstream of the filters, aluminum coagulant will automatically dose the effluent for enhanced coagulation. As needed, a coagulant or alkaline addition will be provided upstream of the clarifiers to enhance settling, phosphorus removal, and alkalinity stabilization.
34. The upgraded Facility includes tertiary treatment consisting of four sections, including a pre-filter channel, post-filter channel, two Veolia Hydrotech™ Disk Filters, and two chlorine contact basins. Filter backwash discharges to an overflow weir box connected to the emergency storage basin. The overflow weir box will also be used to recycle out-of-compliance water by closing two automated gates when post filtration turbidity exceeds 2 NTU (as a 24-hr average), an instantaneous turbidity of 5 NTU, or when post chlorine contact is less than 450 mg-min/L. Out-of-compliance water is discharged back to the headworks until the water meets the aforementioned criteria and is back in compliance.
35. Two chlorine contact basins provide a minimum of 90 minutes of modal contact time at minimum water level using a sodium hypochlorite solution. The contact basins utilize a serpentine design consisting of corrugated fiberglass baffle walls.

Table 9 – Chlorine Contact Basins Design

Parameters	Design Criteria
Number of Basins	2
Capacity per Basin	2.5 mgd
Basin Dimensions (L x W x D)	48 ft x 30 ft x 8.5-10.5 ft
Volume Per Basin	92,000 gallons

36. Final disinfected effluent is discharged through a 20-inch connection to the TUD recycled water distribution system. Recycled water is then conveyed to Quartz Reservoir and TUD’s recycled water users. This Order covers the Facility and its effluent discharge to the recycled water distribution system at the 20-inch connection. This Order does not cover effluent or recycled water distribution and use past this 20-inch connection.
37. Solids processing upgrades are currently under construction. The old anaerobic digesters are being converted to include a membrane thickener and two-stage aerobic digestion (two digesters). Installation of the new dewatering by screw press is complete. Two existing concrete lined sludge drying beds remain onsite

for emergency use if the new screw press were to fail. Three aerobic digestion blowers (two duty, one standby) will serve both the primary and secondary aerobic digesters. The screw press may draw from either the primary or secondary digester using two dewatering feed pumps. Solids dewatering, handling, and storage occurs entirely within a new enclosed solids dewatering building.

38. The two sludge drying beds are concrete lined and overlain with plastic tiles that collect water from the drying process for return to the headworks for treatment. Three sand drying beds were demolished. Only the two-remaining concrete-lined drying beds will remain connected to the digester plumbing system and headworks, but they are currently not in use and TUD does not anticipate using them in the foreseeable future. One unlined sludge drying bed exists, however, TUD has decommissioned it and stated that they no longer intend on using it.
39. According to the September 2022 RWD, sludge will meet the requirements of 40 Code of Regulations (C.F.R.) part 503 for class B pathogen reduction with a solids retention time of 28 days. Dry biosolids cake is collected in an onsite trailer that is fully enclosed within the solids handling building until it is hauled offsite for land application or disposal.

Wastewater Collection System

40. The TUD wastewater collection system consists of approximately 140 miles of 2-inch to 18-inch diameter pipe, flowing by gravity and pumped using 29 sewer pump stations in the surrounding areas of Columbia, East Sonora, Mono Vista, Ranchos Poquitos, Standard, Twain Harte, and Willow Springs. The collection system was regionalized in the 1970's and pipe materials vary widely including asbestos cement, polyvinyl chloride, vitrified clay, cast iron, and bitumized fiber (orangeburg) pipe.
41. According to TUD, the District has an aggressive maintenance program, which incorporates closed circuit television inspections and timely repairs of defects within the regional collection system. In addition, TUD staff have installed thousands of infiltration dishes inside manholes to intercept and collect rainwater flowing through the pick holes of the manhole covers and has installed several miles of cured-in-place pipe lining. As a result, inflow and infiltration has decreased substantially over the last ten years.
42. According to the California Office of Environmental Health Hazard Assessment, California receives about 75 percent of its annual precipitation between November through March, with about 50 percent occurring from December through February. However, precipitation in California has become increasingly variable since the 1980s, with years of high precipitation (wet years) followed by years of low precipitation (dry years). As mentioned in the preceding Finding,

TUD has implemented measures to reduce infiltration and inflows to the Facility. However, based on available flow data, infiltration and inflow still appears to increase flows to the Facility. Therefore, it is appropriate to continue to specify an ADWF limit for the Facility.

Industrial Pretreatment Considerations

43. Certain industrial wastes, when discharged to WWTFs without adequate controls, may cause one or more of the following problems:
 - a. **Interference or Upset.** Discharges of high volumes or concentrations of certain waste constituents may inhibit or disrupt the WWTF, its treatment processes or operations, or its sludge processes, use or disposal, and therefore, causing a violation of a requirement of the WWTF's WDRs or prevention of sewage sludge use or disposal in compliance with applicable statutory provisions, regulations, and permits.
 - b. **Sludge Management.** Industrial wastes, particularly metals and other toxic constituents, can limit available sludge management alternatives, thereby increasing the cost of sludge management and disposal. Contaminated biosolids may also be unsuitable as a soil amendment.
 - c. **Pass-Through.** Some industrial wastes may not receive adequate treatment and pass through the treatment system in concentrations that could cause a violation of any requirements of the WWTF's permit.
 - d. **Other Hazards.** Additionally, the discharge of explosive, reactive, or corrosive wastes can cause damage to the wastewater collection system or the treatment works, as well as threaten the safety of workers and/or the general public.

44. In accordance with California Code of Regulations, title 23, sections 2233 and 2235.3, non-NPDES WDRs for all WWTFs with an average dry weather flow greater of 5 mgd or more must include condition requiring the discharger to have and enforce an adequate pretreatment program approved by the appropriate regional water board. WWTFs with design flows of less than 5 mgd may also be required to develop and implement a pretreatment program if deemed appropriate by the appropriate regional water board. Generally speaking, the Central Valley Water Board may find pretreatment conditions appropriate where a WWTF's influent from industrial users causes treatment process upsets, effluent violations, or sludge contamination. Currently, there are reportedly no significant industrial wastes being discharged to the Facility, and hence no treatment process upsets, effluent violations, or sludge contamination associated with industrial users. TUD provided biosolids sample data from January 2018 to March 2023, which indicated that metal concentrations in the biosolids were well

below pollutant concentrations identified in Table 3 of 40 C.F.R. part 503.13. Consequently, an Industrial Pretreatment Program (IPP) will not be required at this time. However, this Order requires the Discharger to report any proposed new industrial discharges and, if directed by the Executive Officer, to develop an IPP regulating such discharges. Additionally, this Order may be subsequently revised to require compliance with an approved program, if necessary.

Water Recycling Considerations

45. Undisinfected domestic wastewater contains human pathogens that are typically measured using total or fecal coliform organisms as indicator organisms.
46. The State Water Board's Division of Drinking Water (DDW), which is charged with establishing drinking water quality standards for the protection of public health, has promulgated a criteria for the use of recycled water throughout California, codified as California Code of Regulations, title 22 (Title 22), section 60301 et seq.
47. TUD submitted a Title 22 Engineering Report to the Central Valley Water Board for the recycling of disinfected tertiary recycled water (see Title 22, § 60301.230). Central Valley Water Board staff sent a copy of the Title 22 Engineering Report to DDW on 16 November 2022. DDW has yet to provide a determination on the Title 22 Engineer Report.
48. This Order regulates the production of recycled water and its discharge into the TUD reclamation system at the Facility. It does not include reclamation requirements pursuant to Title 22. Provision I.4 of this Order requires TUD to submit a Notice of Intent for enrollment in the State Water Board's Reclamation General Order to facilitate recycled water use and reduce demand on potable supplies. WDRs and Master Reclamation Permit Order R5-2002-0202 will be rescinded once TUD has been enrolled under the Reclamation General Order.
49. Recycled water from the Quartz Reservoir (consisting of treated wastewater from JSD WWTF and TUD's Sonora WWTF) is sent to end-users that apply the water to use areas. TUD is responsible for the operation of both the irrigation system and Quartz Reservoir. JSD contributes approximately 15 percent of the flows into Quartz Reservoir. Initial irrigation deliveries from Quartz were made on an interim basis in 1978 and full delivery commenced in 1979.
50. The JSD WWTF produces disinfected secondary-23 recycled water. To comply with the JSD-TUD Agreement, JSD is investigating ways to upgrade facilities to treat all effluent to disinfected tertiary standards while being fiscally responsible to JSD ratepayers. WDRs Order R5-2021-0046 covers JSD WWTF's production and discharge of recycled water to TUD's reclamation system.

51. There are 23 end users that apply the reclaimed water to approximately 854 acres, including the 252-acre Teleli Golf Course, which still needs infrastructure improvements to supply recycled water to its irrigation system. The reclaimed water is currently used for spray or flood irrigation of fodder crops and pasture for animals not producing milk for human consumption. The two largest use areas, the Gardella property and the Rosasco property, have been subject to groundwater monitoring pursuant to the WDRs and Master Reclamation Permit Order.
52. The discharges authorized herein are consistent with State Water Board Resolution 2009-0011, *Policy for Water Quality Control for Recycled Water* (Recycled Water Policy), as amended per Resolutions 2013-0003 and 2018-0057; and Central Valley Water Board Resolution R5-2009-0028, *Resolution in Support of Regionalization, Reclamation, Recycling and Conservation for WWTPs*.

Site-Specific Conditions

Topography, Climate and Land Use

53. The topography at the Facility consists of gentle slopes with an elevation of approximately 1,600 feet above mean sea level. Sonora is in the foothills of the Sierra Nevada Mountain Range in a high rainfall region characterized by cool to hot summers and generally mild but unpredictable winters with temperatures dropping below freezing at times.
54. Woods Creek, a perennial stream and a tributary of Don Pedro Reservoir, flows within approximately 500 feet to the west of Quartz Reservoir and directly to the west of the Facility.
55. According to the RWD, soils within the City of Sonora are generally shallow consisting of limestone.
56. According to National Oceanic and Atmospheric Administration (NOAA) Precipitation Frequency Atlas 14, Vol. 6 (rev. 2014), 100-year and 1,000-year, 24-hour rainfall events are estimated to result in 6.33 and 8.92 inches of precipitation, respectively.¹ According to the [Federal Emergency Management Agency's \(FEMA\) Food Insurance Rate Map](https://www.fema.gov/portal) (Number 06109C0850C) (<https://msc.fema.gov/portal>), the west portion of the Facility is listed in Zone A,

¹ Source: [NOAA Precipitation Frequency Data Server](https://hdsc.nws.noaa.gov/hdsc/pfds) (<https://hdsc.nws.noaa.gov/hdsc/pfds>)

an are' subject to inundation by the one-percent annual chance flood event, while the east portion is listed as being in Zone X, an area of minimal flood hazard.

57. Surrounding land use is primarily mixed residential, agricultural, and open spaces. Typical crops grown in the area are fodder crops and pasture grasses.
58. Within the region, TUD supplies drinking water obtained from eleven surface water treatment plants and twelve active supply wells. Average water quality, determined as the arithmetic mean of all the sources listed in TUD's Consumer Confidence Reports, is tabulated below. A portion of the population served by the Facility also receives their drinking water from private groundwater wells.

Table 10 – Source Water Quality

Constituent	Units	2017	2018	2019	2020	2021
Chlorine	mg/L	1.1	1.2	1.3	1.3	1.3
Haloacetic Acids	µg/L	27.9	22.9	27.9	22.9	21.6
Nitrate (as N)	mg/L	1.0	0.6	0.6	0.76	0.70
Total Trihalomethanes	µg/L	26.5	29.6	26.5	29.0	30.3
Turbidity	NTU	0.25	0.19	0.19	0.19	0.06
Copper	mg/L	0.90	0.27	0.32	0.31	0.29
Lead	µg/L	0.09	0.42	0.9	1.78	1.78
Iron	µg/L	70.5	15.0	15.0	15.0	14.3
Manganese	µg/L	14.7	5.0	5.0	5.0	8.9
Sulfate	mg/L	2.8	3.0	3.0	3.0	2.3
Zinc	mg/L	0.03	0.03	0.03	0.03	0.05
Sodium	mg/L	9.38	11.5	11.5	11.5	10.8

Groundwater and Subsurface Conditions

59. Groundwater utilized for domestic and irrigation purposes in the vicinity occurs within the bedrock fractures. Domestic and agricultural wells are typically greater than 100 feet in depth. However, due to shallow soil conditions, the TUD monitoring wells are also located within fractured bedrock.
60. The Facility's groundwater monitoring network currently consists of twenty-one groundwater monitoring wells around Quartz Reservoir, the Rosasco Use Area, and the Gardella Use Area. WDR coverage of these storage and land application areas, as well as the groundwater monitoring requirements for these sites are provided in WDRs and Master Reclamation Permit and MRP Orders R5-2002-0202. The Rosasco and Gardella properties were selected to monitor the discharge's potential impact to underlying groundwater as these are the largest reclamation sites. The current groundwater monitoring network is identified in **Table 11** below. This Order covers only the Facility and its discharge

of recycled water into the TUD reclamation system; it does not cover the distribution, storage, and use of recycled water.

Table 11—Reclamation System Groundwater Monitoring Network

Monitoring Well	Well Depth (feet)	Location
M-1	32.02	Quartz Reservoir
M-1R	29.22	Quartz Reservoir
M-2	100.15	Quartz Reservoir
M-3	51.4	Quartz Reservoir
M-3R	43.25	Quartz Reservoir
M-4	105.2	Quartz Reservoir
M-5	70.65	Quartz Reservoir
M-6	16.17	Rosasco Property
M-7	33.43	Rosasco Property
M-8	18.45	Rosasco Property
M-9	26.45	Rosasco Property
M-9R	66.96	Rosasco Property
M-10	28.95	Rosasco Property
M-11	28	Rosasco Property
M-11R	33.2	Rosasco Property
M-12	34.02	Gardella Property
M-13	8.4	Gardella Property
M-14	21.36	Gardella Property
M-15	14.95	Gardella Property
M-16	19.5	Gardella Property
M-16R	26.35	Gardella Property

61. The direction of groundwater flow around the Quartz Reservoir is primarily to the south with Monitoring Wells M-1, M-1R and M-5 as downgradient wells and Monitoring Wells M-2 and M-4 as cross-gradient wells. However, the reservoir is set in a small secondary canyon that slopes to the south/southwest. The Quartz Reservoir backs up against a small geographic divide or saddle where the ground surface slopes to the north/northeast. The saddle forms a hydraulic divide as the groundwater flows north of the divide. Therefore, Monitoring Wells M-3 and M-3R are also downgradient of Quartz Reservoir.
62. According to the 2022 Quarterly Groundwater Monitoring Report conducted by Condor Earth, the depth to groundwater as measured in May 2022 ranged from 6.43 feet below the top of the well casing (MW-1) to 50.68 feet below top of the well casing (M-4). Underneath the Quartz Reservoir, groundwater mainly flowed to the south/southwest during the second quarter of 2021 through the first quarter of 2023.

63. Groundwater quality data collected between December 2007 and May 2022 from the wells around the Quartz Reservoir are summarized in Table 12 below. The number in parenthesis indicates the number of sampling events and the numbers below in parenthesis indicate the range of concentrations.

Table 12 – TUD Monitoring Wells Near Quartz Reservoir

Well	TDS (mg/L)	Chloride (mg/L)	Nitrate (as N) (mg/L)	Iron (mg/L)	Manganese (mg/L)
M-1	629 (59) (410-860)	79 (59) (31-120)	3.55 (59) (0.42-12.0)	0.10 (59) (0.01-4.0)	0.55 (59) (0.2-0.88)
M-1R	590 (9) (520-710)	77 (9) (60-99)	6.07 (9) (1.9-10.0)	0.29 (9) (0.05-1.30)	0.01 (9) (0.01-0.06)
M-2	245 (59) (180-340)	6 (59) (3-9)	0.10 (59) (0.02-0.84)	0.82 (59) (0.07-5.0)	0.32 (59) (0.13-3.3)
M-3	549 (59) (420-720)	28 (59) (20-41)	0.09 (59) (0.02-0.18)	0.50 (59) (0.13-4.3)	0.55 (59) (0.31-3.7)
M-3R	420 (9) (350-480)	20 (9) (14-25)	0.22 (9) (0.05-0.82)	1.0 (9) (0.28-1.9)	0.49 (9) (0.28-0.77)
M-4	255 (59) (190-370)	1 (59) (1-2)	0.07 (59) (0.02-0.09)	0.58 (59) (0.03-6.5)	0.04 (59) (0.01-0.26)
M-5	374 (59) (220-430)	16 (59) (12-23)	0.08 (59) (0.02-0.09)	0.13 (59) (0.03-1.6)	0.3 (59) (0.09-1.8)

64. According to the data from the monitoring wells at Quartz Reservoir, groundwater quality at Monitoring Wells M-2 and M-4 appear to be of good quality for TDS, chloride, and nitrate. However, both wells appear to have concentrations above water quality objectives for iron and manganese. Chloride in monitoring wells M-1 and M-1R is slightly higher than the treated effluent in Quartz Reservoir (Table 3). On average, TDS in the Facility effluent is substantially lower than wells M-1 and M-1R. This mineral characterization indicates that these wells are primarily influenced by sources of water other than Quartz Reservoir.
65. Groundwater beneath the Rosasco Use Area during May 2022 generally ranged from 6 to 34 feet below the top of the well. Groundwater at the Rosasco application area generally flows south based on the 2021 second quarter through 2023 first quarter groundwater monitoring reports. Upgradient groundwater quality is characterized by Monitoring Wells M-7, M-8, and M-9R. Downgradient water quality is characterized by Monitoring Wells M-10, M-11, and M-11R. Groundwater quality between 5 December 2007 and 31 May 2022 is summarized in Table 13 below. Monitoring Well M-6 was dry during the entire period. Also, between February 2016 and May 2022, there was insufficient water to sample.

High variability in data among wells indicates there are multiple different sources of groundwater to these wells.

Table 13 – TUD Monitoring Wells Near Rosasco Use Area

Well	TDS (mg/L)	Chloride (mg/L)	Nitrate (as N) (mg/L)	Iron (mg/L)	Manganese (mg/L)
M-7	703 (59) (490-870)	54 (59) (36-93)	0.78 (59) (0.02-4.0)	3.19 (59) (0.03-30.0)	0.28 (59) (0.04-8.10)
M-8	548 (9) (360-1,100)	46 (9) (17-180)	0.41 (9) (0.02-3.40)	5.42 (9) (0.03-45.0)	2.12 (9) (0.02-9.0)
M-9R	187 (59) (160-210)	10.0 (59) (8.0-13.0)	3.32 (59) (2.8-3.8)	0.26 (59) (0.06-0.81)	0.07 (59) (0.03-0.19)
M-10	700 (59) (270-920)	150 (59) (120-170)	9.96 (59) (7.1-15.0)	2.66 (59) (0.03-21.0)	0.27 (59) (0.00-2.60)
M-11	1,082 (9) (900-1800)	283 (9) (180-350)	5.13 (9) (2.50-6.90)	0.74 (9) (0.03-17.0)	0.03 (9) (0.01-0.66)
M-11R	270 (59) (240-300)	33 (59) (32-35)	0.10 (59) (0.09-0.16)	0.19 (59) (0.12-0.25)	0.53 (59) (0.48-0.57)

66. For the Gardella Use Area, during May 2022, groundwater depth ranged from 4 feet to 30 feet below the top of the well casing. According to the 2021 second quarter groundwater monitoring report through the 2023 first quarter groundwater monitoring report, groundwater gradient below the Gardella Use Area is generally to the south to southwest. Up/cross gradient groundwater data is characterized by Monitoring Well M-12. Groundwater results from December 2007 to May 2022 for the Gardella use area are summarized in Table 14 below. High variability in data among wells indicates there are multiple different sources of groundwater to these wells.

Table 14 – TUD Monitoring Wells Near Gardella Use Area

Well	TDS (mg/L)	Chloride (mg/L)	Nitrate (as N) (mg/L)	Iron (mg/L)	Manganese (mg/L)
M-12	319 (48) (170-1000)	71 (48) (39-330)	3.08 (48) (0.72-6.40)	28.6 (48) (1.0-210.0)	0.57 (48) (0.04-3.30)
M-13	652 (47) (350-1100)	168 (47) (67-400)	8.71 (47) (1.80-27.0)	19.58 (48) (0.2-160.0)	0.20 (48) (0.02-1.40)
M-14	544 (58) (270-1400)	156 (58) (83-610)	2.97 (58) (0.18-13.0)	17.27 (58) (0.03-180)	0.48 (58) (0.00-4.70)
M-15	336 (59) (250-640)	18 (59) (4-240)	0.86 (59) (0.06-4.60)	26.2 (59) (0.03-120)	0.61 (59) (0.01-3.0)
M-16	837 (59) (520-1300)	192 (59) (99-280)	0.3 (59) (0.02-3.70)	9.85 (59) (0.03-110)	0.54 (59) (0.04-2.0)

Well	TDS (mg/L)	Chloride (mg/L)	Nitrate (as N) (mg/L)	Iron (mg/L)	Manganese (mg/L)
M-16R	1124 (9) (920-1200)	160 (9) (150-170)	0.57 (9) (0.36-0.81)	0.32 (9) (0.06-1.30)	0.35 (9) (0.27-0.54)

67. There are currently no monitoring wells located at the Facility and no depth to groundwater information or groundwater elevation maps available for the region. A review of the State Water Board’s Groundwater Ambient Monitoring and Assessment Program (GAMA) Groundwater Information System shows two municipal wells (Well A: CA5500005-001-001 and Well B: CA5510001-006-006) within a two-mile radius of the Facility. Water quality data for the two wells are shown in Table 15 below.

Table 15 – Regional Groundwater Results

Constituent	Units	Well A	Well B
Calcium	mg/L	90	40
Sodium	mg/L	20	20
Iron	µg/L	510	3,900
Manganese	µg/L	Not Sampled	210
Nitrate as N	mg/L	4.4	<0.4
TDS	mg/L	Not Sampled	280
EC	µmhos/cm	890	400

Statutory Authority

68. This Order is adopted pursuant to Water Code section 13263, subdivision (a), which provides in pertinent part as follows:

The regional board, after any necessary hearing, shall prescribe requirements as to the nature of any proposed discharge, existing discharge, or material change in an existing discharge, ... with relation to the conditions existing in the disposal area or receiving waters upon, or into which, the discharge is made or proposed.

69. Compliance with section 13263, subdivision (a), including implementation of applicable water quality control plans, is discussed in the findings below.
70. The ability to discharge waste is a privilege, not a right, and adoption of this Order shall not be construed as creating a vested right to continue discharging waste. (Wat. Code, § 13263, subd. (g).)

71. This Order and its associated Monitoring and Reporting Program (MRP) are also adopted pursuant to Water Code section 13267, subdivision (b)(1), which provides as follows:

[T]he regional board may require that any person who has discharged, discharges, or is suspected of having discharged or discharging, or who proposes to discharge waste ... shall furnish, under penalty of perjury, technical or monitoring program reports which the regional board requires. The burden, including costs, of these reports shall bear a reasonable relationship to the need for the report and the benefits to be obtained from the reports. In requiring those reports, the regional board shall provide the person with a written explanation with regard to the need for the reports, and shall identify the evidence that supports requiring that person to provide the reports.

72. The reports required under this Order, as well as under the separately issued MRP Order, are necessary to verify and ensure compliance with WDRs. The burden associated with such reports is reasonable relative to the need for their submission.

Basin Plan Implementation

73. Pursuant to Water Code section 13263, subdivision (a), WDRs must “implement any relevant water quality control plans ... and shall take into consideration the beneficial uses to be protected, the water quality objectives reasonably required for that purpose, other waste discharges, the need to prevent nuisance, and the provisions of Section 13241.”

Beneficial Uses of Water

74. This Order implements the Central Valley Water Board’s Water Quality Control Plan for the Sacramento River Basin and the San Joaquin River Basin (Basin Plan), which designates beneficial uses for surface water and groundwater and establishes water quality objectives (WQOs) necessary to preserve such beneficial uses. (See Wat. Code, § 13241 et seq.)
75. Local drainage is to the Woods Creek, a tributary to New Don Pedro Reservoir the beneficial uses of which include: municipal and beneficial use (MUN); industrial power (POW); water contact recreation (REC-1); non-water contact recreation (REC-2); warm freshwater habitat (WARM); cold freshwater habitat (COLD); and wildlife habitat (WILD).

76. Beneficial uses of underlying groundwater at the Facility are: municipal and domestic supply (MUN); agricultural supply (AGR); industrial service supply (IND); and industrial process supply (PRO).

Water Quality Objectives

77. The numeric WQO for bacteria is expressed as the most probable number (MPN) of coliform organisms per 100 mL of water. For MUN-designated groundwater, the objective is an MPN of 2.2 organisms over any seven-day period.
78. The narrative WQO for chemical constituents in groundwater generally provides that groundwater shall not contain constituents in concentrations adversely affecting beneficial uses. For MUN-designated waters, the Basin Plan further provides that such water shall, at a minimum, meet the primary and secondary maximum contaminant levels (MCLs) specified in Title 22.² (See Title 22, §§ 64431, 64444, 64449.)
79. The narrative WQO for toxicity provides that groundwater shall be maintained free of toxic substances in concentrations producing detrimental physiological responses in human, animal, plant, or aquatic life associated with designated beneficial uses.
80. To the extent necessary, narrative WQOs are quantified, on a site-specific basis, as numeric limits for constituents with potential to adversely impact designated uses. In determining a site-specific numeric limit, the Central Valley Water Board considers relevant published criteria.
81. In determining a numeric limit for salinity protective of agricultural supply (AGR), the Central Valley Water Board is relying on general salt tolerance guidelines, which indicate that although yield reductions in nearly all crops are not evident when irrigation water has an electrical conductivity (EC) of less than 700 µmhos/cm, there is an eight- to ten-fold range in salt tolerance for agricultural crops. (See, e.g., Ayers & Westcot, *Water Quality for Agriculture* (1985), § 2.3.) For this reason, appropriate salinity values are considered on a case-by-case basis. It is possible to achieve full yield potential with groundwater EC up to 3,000 µmhos/cm, if the proper leaching fraction is provided to maintain soil salinity within the tolerance of the crop.

² Central Valley Water Board may apply limits more stringent than MCLs to ensure that waters do not contain chemical constituents in concentrations that adversely affect beneficial uses.

82. The list of crops in the findings is not intended as a definitive inventory of crops that are or could be grown in the area where groundwater quality is potentially affected by the discharge, but it is representative of current and historical agricultural practices in the area.

Salt and Nitrate Control Programs

83. The Central Valley Water Board adopted Basin Plan amendments incorporating the Salt and Nitrate Control Programs, new programs for addressing ongoing salt and nitrate accumulation in the Central Valley at its 31 May 2018 Board Meeting (Resolution R5-2018-0034). The Basin Plan amendments became effective on 17 January 2020 and were revised by the Central Valley Water Board in 2020 with [Resolution R5-2020-0057](https://www.waterboards.ca.gov/centralvalley/board_decisions/adopted_orders/re_solutions/r5-2020-0057_res.pdf), effective 10 November 2021. (See https://www.waterboards.ca.gov/centralvalley/board_decisions/adopted_orders/re_solutions/r5-2020-0057_res.pdf.)
84. For the Salt Control Program, dischargers that are unable to comply with stringent salinity requirements are instead required to meet performance-based limits and participate in a basin-wide effort known as the Prioritization and Optimization Study (P&O Study) to develop a long-term salinity strategy for the Central Valley. The Discharger was issued a Notice to Comply with the Salt Control Program (**CV-SALTS ID: 2511**) on 5 January 2021. TUD elected to participate in the P&O Study and submitted the required fee to comply with the Salt Control Program. This Order does not preclude TUD from switching to the Conservative Salinity Permitting Approach in the future, if approved by the Central Valley Water Board. These WDRs would need to be revised by the Central Valley Water Board to authorize any such change and to include conservative effluent limitations for salinity. In the interim, to maintain existing salt discharges and minimize salinity impacts, this Order does the following:
- a. Requires the discharger to continue efforts to control salinity in its discharge to the extent feasible; and
 - b. Sets a Salinity Action Level of 800 $\mu\text{mhos/cm}$ for EC for the discharge of wastewater to the reclaimed water distribution system. The current WDRs Order does not include an EC limit on the effluent limitations for discharges to land. However, the Salinity Action Level was determined as the average of EC for the past five years times 125 percent. Based on the available data in **Table 2**, the Facility's discharge can consistently comply with this limit. Therefore, to ensure TUD maintains current salinity discharge concentrations, these WDRs specify an EC Salinity Action Level of 800 $\mu\text{mhos/cm}$.
85. For the Nitrate Control Program, dischargers of nitrate to groundwater basins or sub-basins that are unable to comply with stringent nitrate limits will be required

to take on alternate compliance approaches that involve providing replacement drinking water to persons whose drinking water is affected by nitrates. The Facility falls outside a groundwater basin and therefore is not subject to the Nitrate Control Program. Nevertheless, a Notice to Comply with the Nitrate Control Program may be issued at a later date if the Central Valley Water Board Executive Officer determines it is necessary to protect water quality. Under these circumstances, it may be necessary to modify this Order to incorporate applicable Nitrate Control Program findings and requirements.

Antidegradation Policy

86. State Water Board Resolution 68-16, *Statement of Policy with Respect to Maintaining High Quality Waters in California* (Antidegradation Policy), which is incorporated as part of the Basin Plan, prohibits the Central Valley Water Board from authorizing degradation of high quality waters unless it is shown that the discharge(s) causing such degradation will be consistent with the maximum benefit to the people of California, will not unreasonably affect beneficial uses, and will not result in water quality worse than applicable WQOs. Any discharge to high quality waters must meet requirements that will result in the best practicable treatment or control (BPTC) necessary to assure that pollution or nuisance will not occur and the highest water quality consistent with the maximum benefit to the people of the State will be maintained.
87. The scope of this Order is limited to the treatment of domestic wastewater at the Facility. Offsite reclamation activities are currently covered under the separately issued WDRs and Master Reclamation Permit Order R5-2002-0202, which will be replaced with Reclamation General Order in the future. The Facility, with the recently completed upgrades, implements adequate controls to limit degradation of underlying groundwater such as lining the extended aeration activated sludge basins and emergency storage basin, installing an underdrain system, and maintaining enclosed solids handling facilities. Therefore, activities regulated by these WDRs are not anticipated to degrade or otherwise impact underlying groundwater.
88. Based on the foregoing, the adoption of this Order is consistent with the Antidegradation Policy.

California Environmental Quality Act

89. In accordance with the California Environmental Quality Act (CEQA) (Pub. Res. Code, § 21000 et seq.), the Discharger filed a Mitigated Negative Declaration (MND) (SCH 2019129009) on 3 December 2019 evaluating its decision to upgrade the Facility. In the MND, the Discharger found that the project, incorporating mitigation measures identified in the MND, would not have a significant effect on the environment. The Central Valley Water Board, as a

responsible agency under CEQA, has reviewed the MND and determined that the discharges and other activities authorized under this Order fall within the scope of the project evaluated in the MND.

Other Regulatory Considerations

Water Code Section 13149.2

90. These WDRs regulate a facility that may impact a disadvantaged community and tribal community and includes an alternative compliance path that allows the Discharger time to come into compliance with applicable water quality objectives (i.e., salinity). The Discharger has elected to participate in the Alternative Salinity Permitting Approach for the Salt Control Program, which provides an alternative approach for compliance with salinity limits through implementation of specific requirements (i.e., support facilitation and completion of the P&O Study). The Discharger notified Central Valley Water Board staff that they are exploring the possibility of switching to the conservative compliance path, which would require compliance with lower salinity limits. The Central Valley Water Board has satisfied the outreach requirements set forth in Water Code section 189.7 by conducting outreach in potentially affected disadvantaged and tribal communities through its notice and comment procedures. Specifically, Central Valley Water Board sent a letter on 7 August 2023 to nearby tribal communities to inform them of the project and the opportunity to consult with the Central Valley Water Board on the project. A similar email was also sent to nearby environmental justice groups. No responses were received. Pursuant to Water Code section 13149.2, and as discussed in the following findings, the Central Valley Water Board reviewed readily available information and information raised by interested persons concerning anticipated water quality impacts in disadvantaged communities resulting from adoption of this Order. The Board also considered environmental justice concerns within the Board's authority previously raised by interested persons with regard to those impacts.

Human Right to Water

91. Pursuant to Water Code section 106.3, subdivision (a), it is "the established policy of the state that every human being has the right to safe, clean, affordable, and accessible water adequate for human consumption, cooking, and sanitary purposes." Although this Order is not subject to Water Code section 106.3, as it does not revise, adopt, or establish a policy, regulation, or grant criterion (see § 106.3, subd. (b)), it nevertheless promotes the policy by requiring discharges to meet maximum contaminant levels (MCLs) for drinking water (excluding salinity), which are designed to protect human health and ensure that water is safe for domestic use. For salinity, this Order requires compliance with the Salt Control Program. Although the Basin Plans' Exceptions Policy for Salinity allows participants in the Salt Control Program to obtain limited-term exceptions from

MCLs for salinity, this Program is consistent with the Human Right to Water Policy because its over-arching management goals and priorities include long-term restoration of impacted groundwater basins and sub-basins where practicable.

Threat-Complexity Rating

92. For the purposes of California Code of Regulations, title 23, section 2200, the Facility has a threat-complexity rating of **2-B**.
- a. Threat Category “2” reflects waste discharges that can impair receiving water beneficial uses, cause short-term water quality objective violations, cause secondary drinking water standard violations, and cause nuisances.
 - b. Complexity Category “B” reflects any discharger not included in Category A, with either (1) physical, chemical or biological treatment systems (except for septic systems with subsurface disposal), or (2) any Class II or Class III WMUs.

Title 27 Exemption

93. This Order, which prescribes WDRs for discharges of domestic sewage or treated effluent from a municipal treatment plant, is exempt from the prescriptive requirements of California Code of Regulations, title 27, section 20005 et seq. (See Cal. Code Regs., tit. 27, § 20090, subd. (a).)

Stormwater

94. This Order does not regulate discharges of stormwater or other discharges that are subject to the federal Clean Water Act’s National Pollutant Discharge Elimination System (NPDES). With respect to stormwater, the Discharger is covered under State Water Board Order 2014-0057 DWQ, NPDES General Permit CAS000001, the statewide General Permit for Storm Water Discharges Associated with Industrial Activities (Industrial General Permit).

Sanitary Sewer Overflows

95. Sanitary Sewer Overflows³ (SSOs), which typically consist of a mixture of domestic and commercial wastewater, often contain pathogenic organisms, toxic

³ For the purposes of this Order, a “**Sanitary Sewer Overflow**” is a discharge to ground or surface water from the sanitary sewer system at any point upstream of the treatment facility. Temporary storage and conveyance facilities (e.g., wet wells, regulated

pollutants, nutrients, oxygen demanding organic compounds, oil and grease, suspended solids and other pollutants. When an SSO results in a discharge to surface water, it can cause temporary exceedances of WQOs, pose a threat to public health, adversely affect aquatic life, and impair recreational use and aesthetic enjoyment of surface waters in the area. The most common causes are grease blockages, root blockages, debris blockages, sewer line flood damage, manhole structure failures, vandalism, pump station mechanical failures, power outages, storm or groundwater inflow/infiltration, lack of capacity, and/or contractor-caused blockages. On 6 December 2022, the State Water Board adopted Order 2022-0013-DWQ, *Statewide General Waste Discharge Requirements for Sanitary Sewer Systems* (SSO General Order), under which all public agencies owning or operating sanitary sewer systems with total systems in excess of one mile must enroll. The TUD collection system exceeds one mile in length and TUD is enrolled under the General Order.

Biosolids

96. The United States Environmental Protection Agency (U.S. EPA) has promulgated biosolids reuse regulations in 40 C.F.R. part 503, *Standards for the Use or Disposal of Sewage Sludge* (Part 503), which establishes management criteria for protection of ground and surface waters, sets limits and application rates for heavy metals, and establishes stabilization and disinfection criteria. The Central Valley Water Board is not the implementing Agency for Part 503 regulations. The Discharger may have separate and/or additional compliance, reporting, and permitting responsibilities to the U.S. EPA.

Groundwater Wells

97. Existing Department of Water Resources (DWR) standards for the construction and destruction of groundwater wells, as well as any more stringent standards that are subsequently adopted, shall apply to all monitoring wells used to monitor impacts of wastewater storage or disposal governed by this Order. (See DWR, Cal. Well Stds. Bulletins 74-90 (1991) and 74-81 (1981).)
98. Statistical data analysis methods outlined in the U.S. EPA's Statistical Analysis of Groundwater Monitoring Data at RCRA Facilities, Unified Guidance (Unified Guidance) are appropriate for determining compliance with the Groundwater

impoundments, tanks, highlines, etc.) may be part of a sanitary sewer system and discharges to these facilities are not considered SSOs, provided that the waste is fully contained within these temporary storage/conveyance facilities.

Limitations of this Order. Depending on the circumstances, other methods may also be appropriate.

Scope of Order

99. This Order is strictly limited in scope to those waste discharges, activities, and processes described and expressly authorized herein.
100. Pursuant to Water Code section 13264, subdivision (a), the Discharger is prohibited from initiating the discharge of new wastes (i.e., other than those described herein), or making material changes to the character, volume, and/or timing of waste discharges authorized herein, without filing a RWD per Water Code section 13260.
101. Failure to file a new RWD before initiating material changes to the character, volume, and/or timing of discharges authorized herein shall constitute an independent violation of these WDRs.
102. This Order is also strictly limited in applicability to those individuals and/or entities specifically designated herein as “Discharger,” subject only to the Central Valley Water Board’s designation of new or different parties as dischargers subject to this Order.

Procedural Matters

103. All of the above information, as well as the information contained in the attached Information Sheet, was considered by the Central Valley Water Board in prescribing the WDRs set forth below.
104. The Discharger, interested agencies, and other interested persons were notified of the Central Valley Water Board’s intent to prescribe the WDRs in this Order and provided an opportunity to submit their written views and recommendations at a public hearing. (See Wat. Code, § 13167.5.)
105. At a public meeting, the Central Valley Water Board heard and considered all comments pertaining to the discharges regulated under this Order.
106. The Central Valley Water Board will review and revise the WDRs in this Order as necessary.

REQUIREMENTS

IT IS HEREBY ORDERED, pursuant to Water Code sections 13263 and 13267, that WDRs Order 94-192 and CDO R5-2002-0203 are rescinded (except for enforcement purposes); and that the Discharger and their agents, employees and successors shall comply with the following. CDO R5-2002-0203 was rescinded as a separate Board

Meeting item at the 19 April 2024 Central Valley Water Board meeting (Order R5-2024-0012).

A. Standard Provisions

Except as expressly provided herein, the Discharger shall comply with the Standard Provisions and Reporting Requirements dated 1 March 1991 (SPRRs).

B. Discharge Prohibitions

1. Waste classified as “hazardous” (per Cal. Code Regs., tit. 22, § 66261.1 et seq.) shall not be discharged at the Facility under any circumstance.
2. Waste constituents shall not be discharged or otherwise released from the Facility (including during treatment and storage activities) in a manner that results in:
 - a. Violations of the Groundwater Limitations of this Order; or
 - b. Conditions of “nuisance” or “pollution,” as defined per Water Code section 13050.
3. Except as otherwise expressly authorized in this Order, sewage and other waste shall not be discharged to surface waters or surface water drainage courses (including irrigation ditches outside of Discharger's control).
4. Except as provided in Section E.2 of the SPRRs, untreated wastes and partially treated wastes shall not bypass the treatment system (including treatment basins).
5. Waste shall not be discharged from the Facility in a manner other than as described in this Order.
6. Toxic substances shall not be discharged into the wastewater treatment system such that biological treatment mechanisms are substantially disrupted.

C. Effluent Flow Limitations

1. Effluent flows from the Facility, monitored at EFF-001 (as defined in the MRP), shall not exceed the following limits:

Table 16—Effluent Flow Limitations

Flow Measurement	Units	Limit
Average Monthly Dry Weather Flow (see i below)	mgd	1.84 / 2.0 (see ii below)
Maximum Daily Flow	mgd	5.0

- i. The average dry weather discharge flow represents the daily average flow when groundwater is at or near normal and runoff is not occurring. Compliance with the average dry weather flow limitation will be determined annually based on the average daily flow over three consecutive dry weather months (e.g., June through September).
- ii. The Discharger shall comply with the 1.84 mgd effluent flow limitation until Provision I.5 has been satisfied and approved by the Central Valley Water Board. Once Provision I.5 has been satisfied and approved by the Central Valley Water Board, the Discharger shall comply with the 2.0 mgd average monthly dry weather flow limitation.

D. Effluent Limitations

1. **Discharge Point EFF-001 (Disinfected Tertiary Effluent).** Disinfected tertiary-treated effluent discharged from the Facility to the TUD Reclamation System, monitored at EFF-001 (as defined in the MRP), shall not exceed the following limits:

Table 17—Tertiary Treated Effluent Limitations

Constituent	Monthly Average	Daily Maximum
BOD ₅	10 mg/L	20 mg/L
TSS	10 mg/L	20 mg/L
Total Nitrogen	10 mg/L	---

2. The median concentration of total coliform bacteria in the disinfected tertiary recycled water shall not exceed any of the following:
 - a. 2.2 most probable number (MPN) per 100 mL as a 7-day median;
 - b. 23 MPN/100 mL more than once in any 30-day period; and
 - c. 240 MPN/100 mL at any time.

E. Salinity Action Level

1. To comply with the Salt Control Program, the Discharger selected the Alternative Salinity Permitting Approach (i.e., participation in the

P&O Study). Therefore, as discussed in Finding 84, these WDRs establish a **Salinity Action Level of 800 $\mu\text{mhos/cm}$** as a calendar year annual average for EC. As part of the Annual Monitoring report required per the MRP, the Discharger shall evaluate the Facility's annual average effluent EC concentration (monitored at EFF-001). If the Facility's discharge exceeds the Salinity Action Level, the Discharger shall submit a **Salinity Action Level Report by 1 March** of the year following the exceedance of the Salinity Action Level. The Salinity Action Level Report shall, at a minimum, include the following:

- a. An evaluation of the Facility's salinity effluent levels. This evaluation shall discuss any changes to the source water for the area served by the WWTF, any new industrial dischargers discharging to the WWTF, any increased conservation efforts implemented within the WWTF service area (with flow data demonstrating decreased flows to the WWTF), and any other changes to the WWTF's collection or treatment system that could have contributed to the increased salinity concentrations.
- b. If additional time is needed to investigate the source(s) of the salinity in the Facility's discharge, the Salinity Action Level Report shall include a detailed work plan describing what actions the Discharger will conduct (with completion dates) to investigate source(s) of salinity and report its findings to the Central Valley Water Board. The Salinity Action Level Report shall evaluate the potential impact the increased salinity concentrations could have on underlying groundwater and downgradient users. If additional time is needed for this evaluation, the Salinity Action Level Report shall propose a submittal date (no later than October 1st of the year following the exceedance of the Salinity Action Level).

F. Discharge Specifications

1. The Discharger shall operate all systems and equipment to optimize the quality of the discharge.
2. All conveyance, treatment, storage, and disposal systems shall be designed, constructed, operated, and maintained to prevent inundation or washout due to floods with a 100-year return frequency.
3. Public contact with wastewater at the Facility shall be prevented through such means as fences, signs, or acceptable alternatives.
4. The Facility's discharge to the reclamation system shall be at least disinfected tertiary recycled water as defined in Title 22, section 60301.230.

5. Wastewater treatment, storage, and disposal shall not cause a condition of pollution or nuisance as defined by Water Code section 13050.
6. For tertiary-treated effluent, prior to disinfection, the turbidity of the filtered effluent, expressed as in Nephelometric Turbidity Units (NTUs), shall not exceed the limits specified below.
 - i. An average of 2 NTU within a 24-hour period,
 - ii. 5 NTU more than 5 percent of the time within a 24-hour period, and
 - iii. 10 NTU at any time.
7. The tertiary-treated filtered effluent shall receive a minimum CT (the product of total chlorine residual and modal contact time measured at the same point) of 450 milligram-minutes per liter at all times with a modal contact time of 90 minutes, based on peak dry weather design flow, unless other CT and modal contact time specifications are approved by DDW.
8. Waste discharges shall remain within authorized waste treatment and/or containment structures.
9. Objectionable odors shall not be perceivable beyond the limits of the Facility property at an intensity that creates or threatens to create nuisance conditions.
10. As a means of ensuring compliance with Discharge Specification F.9, the dissolved oxygen (DO) content in the upper one foot of any storage pond (e.g., emergency storage basin) shall not be less than 1.0 mg/L for three consecutive sampling events. Notwithstanding the DO monitoring frequency specified in the monitoring and reporting program, if the DO in any single pond is below 1.0 mg/L for any single sampling event, the Discharger shall implement daily DO monitoring of that pond until the minimum DO concentration is achieved for at least three consecutive days. If the DO in any single pond is below 1.0 mg/L for three consecutive days, the Discharger shall report the findings to the Central Valley Water Board in accordance with **Section B.1** of the SPRRs. The written notification shall include a specific plan to resolve the low DO results within 30 days of the first date of violation.
11. The Discharger shall design, construct, operate, and maintain all ponds sufficiently to protect the integrity of containment dams and berms and prevent overtopping and/or structural failure. The operating freeboard in any pond shall never be less than two feet (measured vertically from the lowest possible point of overflow). As a means of management and to discern compliance with this requirement, the Discharger shall install and maintain in

- the Emergency Storage Basin a permanent staff gauge with calibration marks that clearly show the water level at design capacity and enable determination of available operational freeboard.
12. Wastewater treatment, storage, and disposal ponds or structures shall have sufficient capacity to accommodate allowable wastewater flow, design seasonal precipitation, and ancillary inflow and infiltration during the winter while ensuring compliance with all requirements of this Order. Design seasonal precipitation shall be based on total annual precipitation using a return period of 100 years, distributed monthly in accordance with historical rainfall patterns.
 13. On or about 1 October of each year, available capacity shall at least equal the volume necessary to comply with Discharge Specifications F.11 and F.12.
 14. All ponds and open containment structures shall be managed to prevent breeding of mosquitoes. Specifically:
 - a. An erosion control program shall be implemented to ensure that small coves and irregularities are not created around the perimeter of the water surface.
 - b. Weeds shall be minimized through control of water depth, harvesting, or herbicides.
 - c. Dead algae, vegetation, and debris shall not accumulate on the water surface.
 15. Newly constructed or rehabilitated berms or levees (excluding internal berms that separate ponds or control the flow of water within a pond) shall be designed and constructed under the supervision of a California Registered Civil Engineer.
 16. All wastewater (untreated and treated) shall be stored in properly lined ponds at the Facility. The Discharger shall maintain the integrity of the liner of the extended aeration activated sludge basins and emergency storage basin. The Discharger shall comply with the following:
 - a. For the extended aeration activated sludge basins: **Beginning in 2026**, the Discharger shall monitor the integrity of the extended aeration activated sludge liners **annually**. This monitoring shall follow the procedures established in the approved Liner Operation & Maintenance Plan (Provision I.6). If the monitoring determines the geotextile liner integrity has been compromised (i.e., significant leaks),

the Discharger shall provide a work plan (within three months) proposing a schedule to repair the liner.

- b. For the emergency storage pond: **Beginning in 2026**, the Discharger shall monitor the integrity of the emergency storage pond at least **once every three years**. This evaluation shall follow the procedures established in the approved Liner Operation & Maintenance Plan (Provision I.6). If the evaluation determines the geotextile liner integrity has been compromised (i.e., significant leaks), the Discharger shall provide a work plan (within three months) proposing a schedule to repair the liner.

G. Groundwater Limitations

Release of waste constituents from any portion of the Facility shall not cause or contribute to groundwater containing constituent concentrations in excess of the concentrations specified below or in excess of natural background quality, whichever is greater:

1. Nitrate (as N) of 10 mg/L.
2. Exceed a total coliform organism level of 2.2 MPN/100 mL over any seven-day period.
3. Constituents in concentrations that exceed either the Primary or Secondary MCLs established in Title 22 of the California Code of Regulations, excluding salinity provided the Discharger complies with Provision I.3 (i.e., complies with the Salt Control Program).
4. Contain taste- or odor-producing constituents, toxic substances, or any other constituents in concentrations that cause nuisance or adversely affect beneficial uses.

H. Solids Disposal Specifications

1. Sludge⁴ and Solid Waste⁵ shall be removed from screens, sumps, ponds, and clarifiers as needed to ensure optimal plant operation.
2. Onsite handling and storage of Residual Sludge,⁶ Solid Waste, and Biosolids⁷ shall be temporary (6 months or less) and controlled and contained in a manner that minimizes leachate formation and precludes infiltration of waste constituents into soils in a mass or concentration that will violate the Groundwater Limitations of this Order. The Discharger shall store all residual sludge, solid waste, and biosolids on properly lined surfaces with containment surfaces to prevent runoff.
3. Residual sludge, biosolids, and solid waste shall be disposed of in a manner approved by the Executive Officer and consistent with Title 27, division 2. Removal for further treatment, disposal, or reuse at disposal sites (i.e., landfills, WWTFs, composting sites, soil amendment sites) operated in accordance with valid waste discharge requirements issued by a regional water board will satisfy this specification.
4. Use of biosolids as a soil amendment shall comply with valid WDRs issued by a regional water board or the State Water Board, except in cases where a local (e.g., county) program has been authorized by a regional water board. In most cases, this will mean State Water Board Water Quality Order 2004-12-DWQ, *General Waste Discharge Requirements for the Discharge of Biosolids to Land for Use as a Soil*

⁴ For the purposes of this section, “**sludge**” means the solid, semisolid, and liquid residues removed during primary, secondary, or advanced wastewater treatment processes.

⁵ For the purposes of this section, “**solid waste**” includes grit and screenings generated during preliminary treatment at the Facility.

⁶ For the purposes of this section, “**residual sludge**” means sludge that will not be subject to further treatment at the Facility.

⁷ For the purposes of this section, “**biosolids**” refers to sludge that has been treated and tested and shown to be capable of being beneficially used as a soil amendment for agriculture, silviculture, horticulture, and land reclamation activities pursuant to federal and state regulations.

Amendment in Agricultural, Silvicultural, Horticultural, and Land Reclamation Activities. For a biosolids-use project to be covered by Order 2004-12-DWQ, the Discharger must file a complete Notice of Intent and receive a Notice of Applicability for each project.

5. Use and disposal of biosolids shall comply with the self-implementing federal regulations of 40 C.F.R. part 503, which are subject to enforcement by the U.S. EPA, not the Central Valley Water Board. If, during the life of this Order, the State accepts primacy for implementation of part 503, the Central Valley Water Board may also initiate enforcement where appropriate.
6. Any proposed change in sludge use or disposal practice shall be reported in writing to the Executive Officer at least 90 days in advance of the change.

I. Provisions

1. The Discharger shall comply with the separately issued MRP Order R5-2024-0016 and any future revisions thereto. The submittal dates of Discharger self-monitoring reports shall be no later than the submittal date specified in the MRP.
2. A copy of this Order, including the MRP, Information Sheet, Attachments, and SPRRs, shall be kept at the discharge facility for reference by operating personnel. Key operating personnel shall be familiar with its contents.
3. The Discharger shall comply with the Salt Control Program by maintaining good standing with the P&O Study.
4. **Within 60 days after receiving a Title 22 Conditional Acceptance Letter from DDW**, the Discharger must apply for coverage under State Water Board Order WQ 2016-0068-DDW, *Water Reclamation Requirements for Reclamation General Order* (Reclamation General Order). As part of the application for the Reclamation General Order, the Discharger must provide a Title 22 Engineering Report approved by DDW. Recycling of tertiary-treated effluent may commence upon enrollment under the Reclamation General Order.
5. **Upon completion of construction of the connection to additional land use areas** (e.g., the Teleli Golf Course), the Discharger shall submit certification that TUD can irrigate with treated recycled effluent as described in Finding 10 and has sufficient storage and disposal capacity for 2.0 mgd (average monthly dry weather flow).

6. **By 19 August 2024**, the Discharger shall submit a **Liner Operation and Maintenance Plan**. The Plan shall address how all synthetically lined ponds/basins at the Facility will be operated and maintained and how the District will operate/monitor the extended aeration activated sludge basins' leak detection system. The Plan shall propose the procedures for adequately monitoring each pond/basin's liner integrity (once a year for the extended aeration activated sludge ponds and once every three years for the emergency storage pond). The Plan shall specify an Action Leakage Level for each pond's underdrain leakage detection system. The Plan shall discuss what actions will be taken if the pond liner monitoring shows that the pond liner integrity has been compromised (i.e., exceedance of the proposed Action Leakage Level).
7. If flows to the Facility have been increasing, or are projected to increase, the Discharger shall estimate when flows will reach hydraulic and treatment capacities of its treatment, collection, and disposal facilities. The projections shall be made in January, based on the last three years' average dry weather flows, peak wet weather flows and total annual flows, as appropriate. When any projection shows that capacity of any part of the facilities may be exceeded in four years, the discharger shall notify the Central Valley Water Board by 31 January.
8. In accordance with Business and Professions Code sections 6735, 7835, and 7835.1, engineering and geologic evaluations and judgments shall be performed by or under the direction of registered professionals competent and proficient in the fields pertinent to the required activities. All technical reports specified herein that contain workplans for investigations and studies, that describe the conduct of investigations and studies, or that contain technical conclusions and recommendations concerning engineering and geology shall be prepared by or under the direction of appropriately qualified professional(s), even if not explicitly stated. Each technical report submitted by the Discharger shall bear the professional's signature and stamp.
9. The Discharger shall submit the technical reports and work plans required by this Order for consideration by the Executive Officer, and incorporate comments the Executive Officer may have, in a timely manner, as appropriate. Unless expressly stated otherwise in this Order, the Discharger shall proceed with all work required by the foregoing provisions by the due dates specified.
10. The Discharger shall comply with all conditions of this Order, including timely submittal of technical and monitoring reports. On or before each report due date, the Discharger shall submit the specified document to the Central Valley Water Board or, if appropriate, a written report detailing

compliance or noncompliance with the specific schedule date and task. If noncompliance is being reported, then the Discharger shall state the reasons for such noncompliance and provide an estimate of the date when the Discharger will be in compliance. The Discharger shall notify the Central Valley Water Board in writing when it returns to compliance with the time schedule. Violations may result in enforcement action, including Central Valley Water Board or court orders requiring corrective action or imposing civil monetary liability, or in revision or rescission of this Order.

11. The Discharger shall at all times properly operate and maintain all facilities and systems of treatment and control (and related appurtenances) that are installed or used by the Discharger to achieve compliance with the conditions of this Order. Proper operation and maintenance also includes adequate laboratory controls and appropriate quality assurance procedures. This provision requires the operation of back-up or auxiliary facilities or similar systems that are installed by the Discharger when the operation is necessary to achieve compliance with the conditions of this Order.
12. The Discharger shall use the best practicable cost-effective control technique(s) including proper operation and maintenance, to comply with this Order.
13. The Discharger shall provide certified wastewater treatment plant operators in accordance with California Code of Regulations, title 23, division 3, chapter 26.
14. As described in the SPRRs, the Discharger shall report promptly to the Central Valley Water Board any material change or proposed change in the character, location, or volume of the discharge.
15. The Discharger shall comply with the requirements of the *Statewide General Waste Discharge Requirements for Sanitary Sewer Systems* (Water Quality Order 2022-0103-DWQ), and any subsequent revisions thereto. Water Quality Order 2022-0103-DWQ requires the Discharger to notify the Central Valley Water Board and take remedial action upon the reduction, loss, or failure of the sanitary sewer system resulting in a sanitary sewer overflow.
16. The Discharger shall report to the Central Valley Water Board any toxic chemical release data it reports to the State Emergency Response Commission within 15 days of reporting the data to the Commission pursuant to section 313 of the "Emergency Planning and Community Right to Know Act of 1986."

17. The Discharger shall not allow pollutant-free wastewater to be discharged into the wastewater collection, treatment, and disposal systems in amounts that significantly diminish the system's capability to comply with this Order. Pollutant-free wastewater means rainfall, groundwater, cooling waters, and condensates that are essentially free of pollutants.
18. At least 90 days prior to termination or expiration of any lease, contract, or agreement involving disposal or recycling areas or off-site reuse of effluent that is used to justify the capacity authorized herein and ensure compliance with this Order, the Discharger shall notify the Central Valley Water Board in writing of the situation and of what measures have been taken or are being taken to ensure full compliance with this Order.
19. In the event of any change in control or ownership of the Facility, the Discharger must notify the succeeding owner or operator of the existence of this Order by letter, a copy of which shall be immediately forwarded to the Central Valley Water Board.
20. To assume operation as Discharger under this Order, the succeeding owner or operator must apply in writing to the Executive Officer requesting transfer of the Order. The request must contain the requesting entity's full legal name, the state of incorporation if a corporation, the name and address and telephone number of the persons responsible for contact with the Central Valley Water Board, and a statement. The statement shall comply with the signatory paragraph of SPRRs Standard Provision B.3 and state that the new owner or operator assumes full responsibility for compliance with this Order. Failure to submit the request shall be considered a discharge without requirements, a violation of the Water Code. If approved by the Executive Officer, the transfer request will be submitted to the Central Valley Water Board for its consideration of transferring the ownership of this Order at one of its regularly scheduled meetings.

ENFORCEMENT

If, in the opinion of the Executive Officer, the Discharger fails to comply with the provisions of this Order, the Executive Officer may refer this matter to the Attorney General for judicial enforcement, may issue a complaint for administrative civil liability, or may take other enforcement actions. Failure to comply with this Order may result in the assessment of Administrative Civil Liability of up to \$10,000 per violation, per day, depending on the violation, pursuant to the Water Code, including sections 13268, 13350, and 13385. The Central Valley Water Board reserves its right to take any enforcement actions authorized by law.

ADMINISTRATIVE REVIEW

Any person aggrieved by this Central Valley Water Board action may petition the State Water Board for review in accordance with Water Code section 13320 and California Code of Regulations, title 23, section 2050 et seq. The State Water Board must receive the petition by 5:00 p.m. on the 30th day after the date of this Order; if the 30th day falls on a Saturday, Sunday, or state holiday, the petition must be received by the State Water Board by 5:00 p.m. on the next business day. Copies of [the law and regulations applicable to filing petitions](#) are available on the Internet (at the address below) and will be provided upon request.

(http://www.waterboards.ca.gov/public_notices/petitions/water_quality)

ATTACHMENTS

Attachment A – Site Location Map

Attachment B – Site Plan

Attachment C – Flow Diagram

Standard Provisions & Reporting Requirements (SPRRs), dated 1 March 1991

Information Sheet

Monitoring and Reporting Program R5-2024-0016

ATTACHMENT A—SITE LOCATION MAP

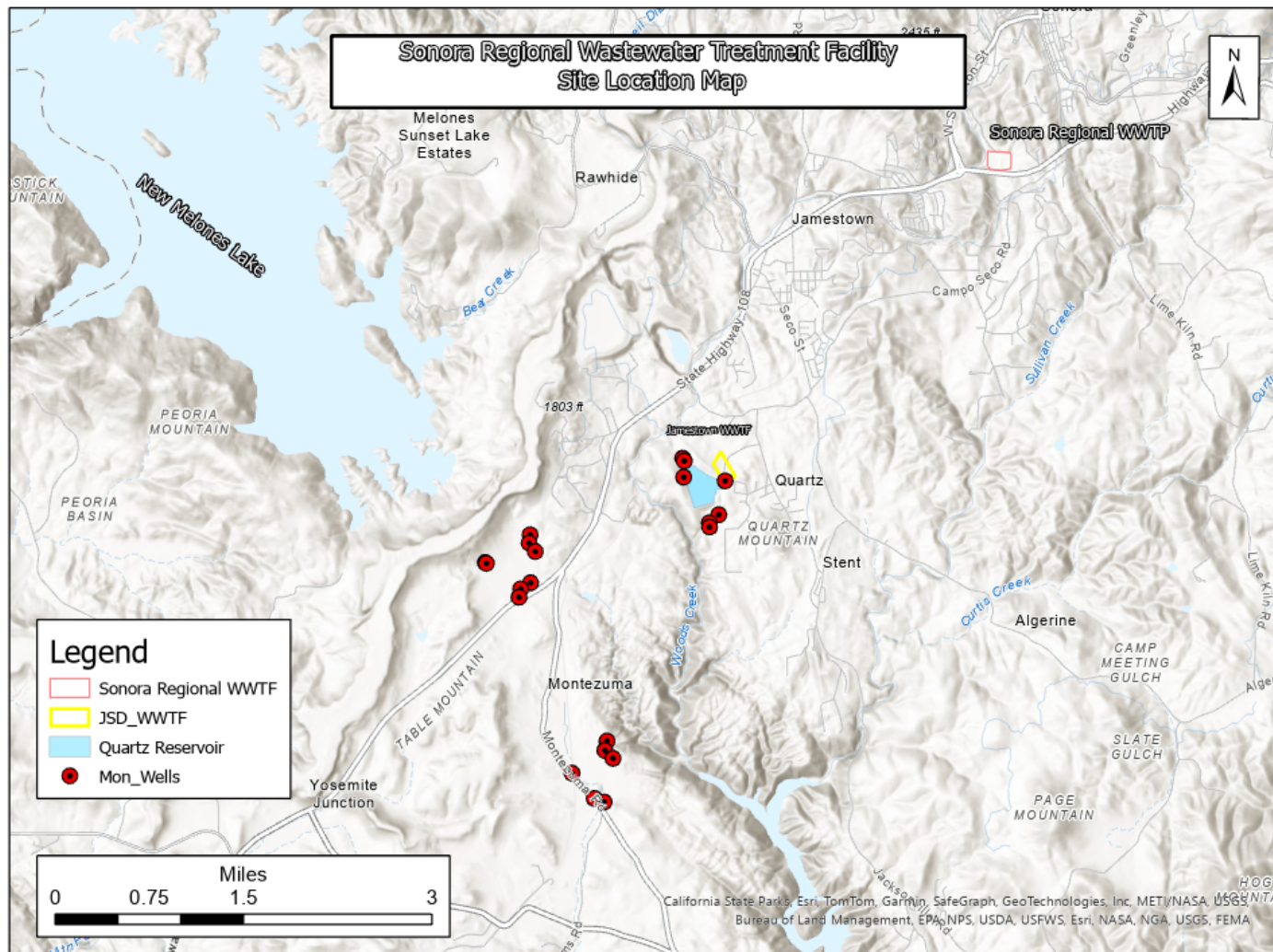

ATTACHMENT B—SITE PLAN

TUOLUMNE WASTEWATER TREATMENT SYSTEM SITE PLAN SONORA, CA

- LEGEND**
- A ADMIN, ELECT, AND BLOWER BUILDING
 - B BIOSOLIDS BUILDING
 - C DIGESTER BUILDING
 - D COLLECTIONS DEPARTMENT OFFICES
 - E EXISTING COVERED STORAGE GARAGE
 - 1 HEADWORKS
 - 2 NORTH PROCESS STATION
 - 3 SECONDARY TREATMENT - BIOLOGICAL BASINS
 - 4 SOUTH PROCESS STATION
 - 5 SECONDARY CLARIFIERS
 - 6 TERTIARY FILTRATION
 - 7 CHLORINE CONTACT STATION
 - 8 CONNECTION TO TUD RECYCLED WATER SYSTEM
 - 9 RENOVATED AEROBIC SLUDGE DIGESTION
 - 10 EXISTING SLUDGE DRYING BEDS
 - 11 NEW CHEMICAL STORAGE
 - 12 NEW EMERGENCY STORAGE BASIN
 - 13 NEW GENERATOR LOCATION
 - 14 SEPTAGE RECEIVING STATIONS - A & B
 - 15 NEW NATURAL DRAINAGE CHANNEL

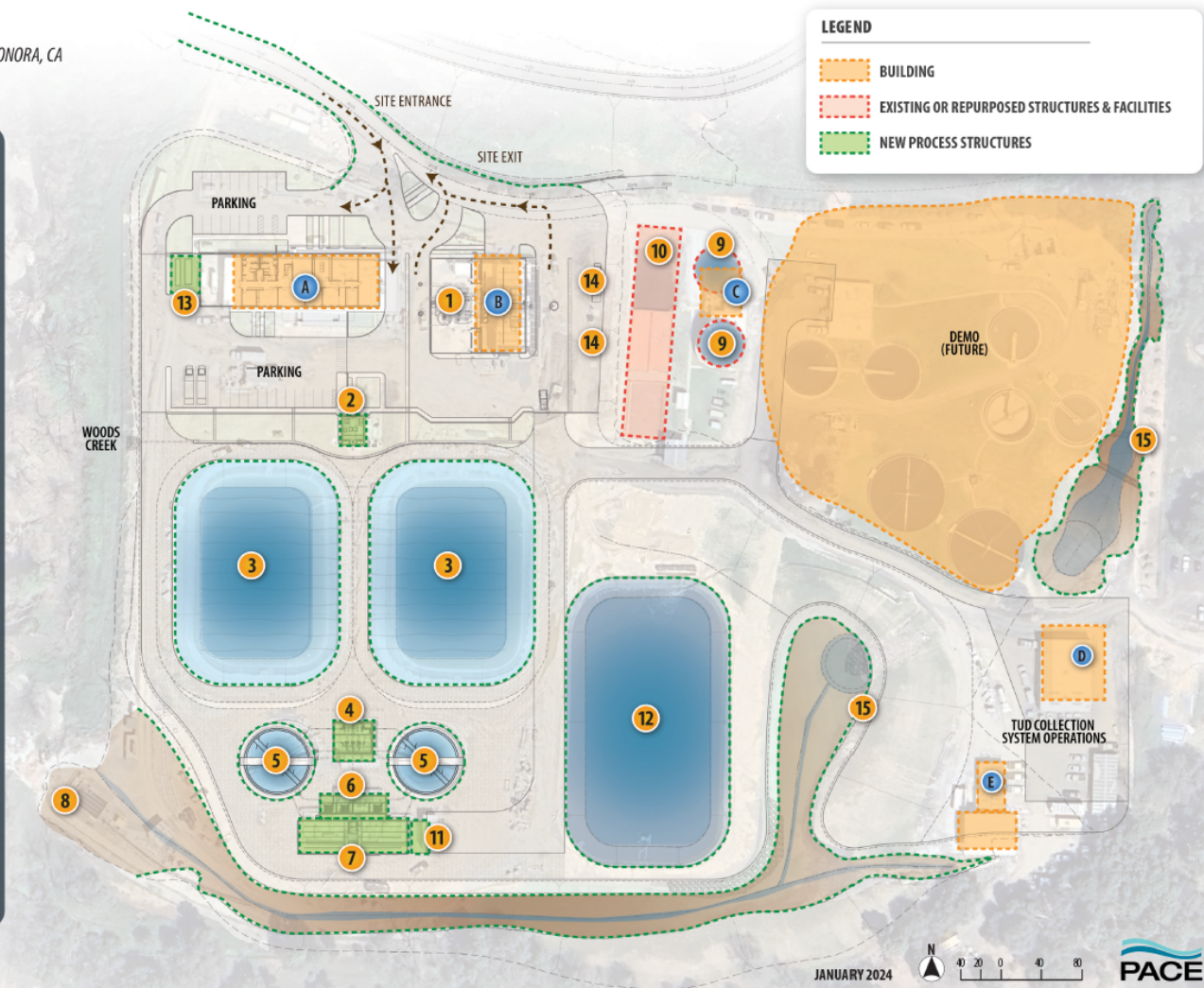

JANUARY 2024

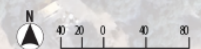

ATTACHMENT C—FLOW DIAGRAM

TUD Sonora Regional Wastewater Treatment Facility

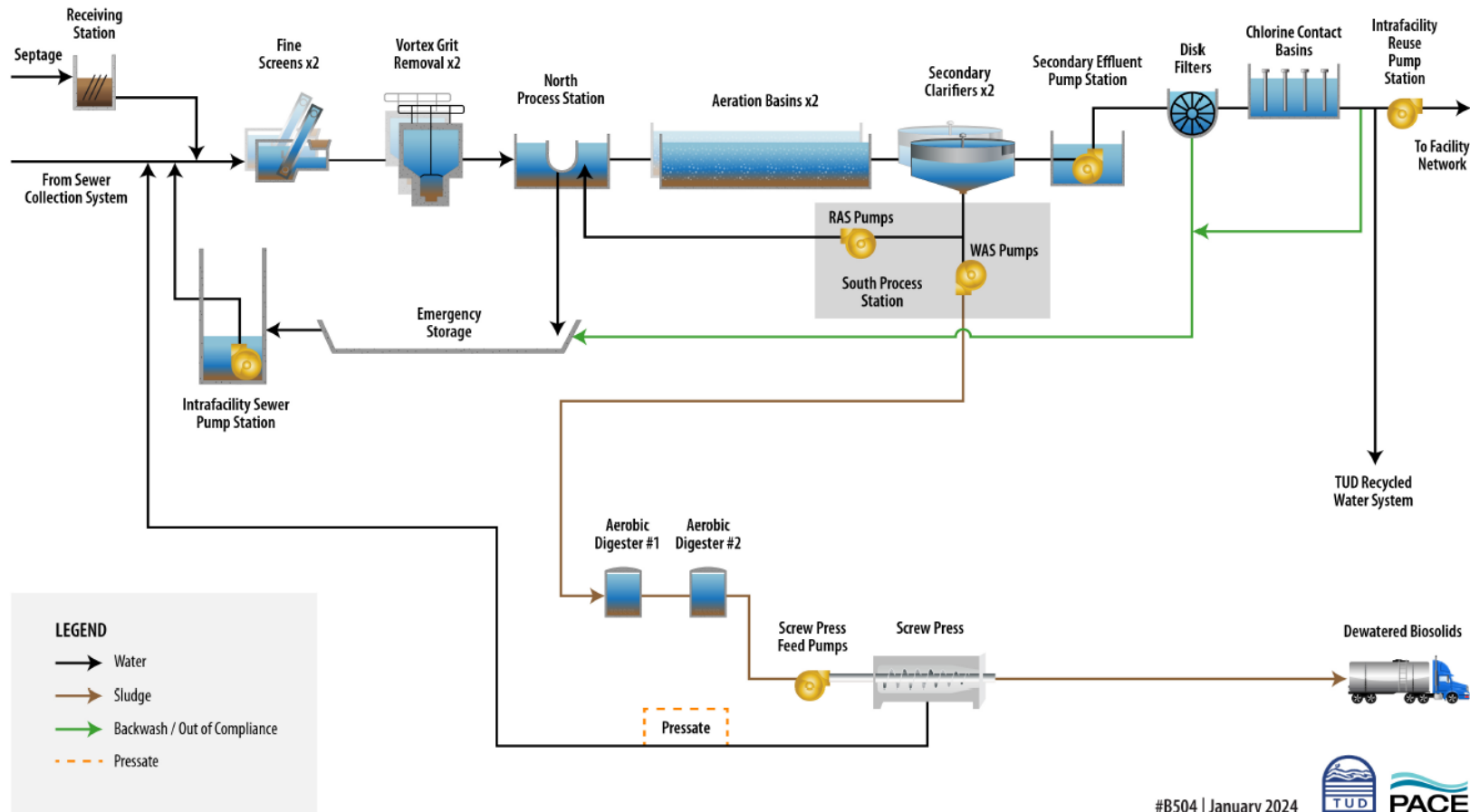

CALIFORNIA REGIONAL WATER QUALITY CONTROL BOARD
CENTRAL VALLEY REGION

Waste Discharge Requirements Order R5-2024-0016
for
Tuolumne Utilities District
Sonora Regional Wastewater Treatment Facility
Tuolumne County

INFORMATION SHEET

BACKGROUND

In September 2022, Pacific Advanced Civil Engineering, Inc. on behalf of the Tuolumne Utilities District (TUD or Discharger), submitted a Report of Waste Discharge (RWD) proposing to upgrade the existing Sonora Regional Wastewater Treatment Facility (WWTF) (the Facility) in Tuolumne County to produce tertiary-treated recycled water. By letter dated 21 October 2022, the Central Valley Water Board notified the Discharger that the September 2022 RWD was incomplete and requested additional information be provided.

On 21 December 2022, the Discharger submitted additional information in a letter to Water Board staff. In addition, on 8 March 2023, Robertson-Bryan, Inc. (RBI), on behalf of the Discharger, submitted two technical memoranda to address some of the deficiencies in the RWD and December 2022 letter. The memoranda included supplemental information and a modified water balance to clarify the storage and irrigation potential of the current system to support the requested average dry-weather flow (ADWF) limit of 2.0 million gallons per day (mgd). After review of these submissions, Central Valley Water Board staff had concerns with the modified water balance, as the acreage for the Teleli Golf Course was included despite that there is not an existing connection between the Facility and the Golf Course.

On 29 June 2023, RBI submitted a subsequent modified water balance to address the disposal and storage capacity of the existing and proposed use areas. The June 2023 modified water balance indicated that for the 100-year rainfall scenario, the existing storage and use areas (total of 603 irrigable acres) could accommodate an ADWF discharge limit of 1.84 mgd, which is expected to occur in 2046. With the inclusion of the Teleli Golf Course (total of 855 irrigable acres), the highest ADWF scenario during a 100-year rainfall scenario would be a discharge limit of 2.08 mgd. The modified water balance also noted that 683 acres (80 additional acres) is required to store and dispose an ADWF of 2.0 mgd during the 100-year rainfall scenario. On 31 August 2023, RBI submitted an Antidegradation Analysis for the discharge from the Facility to Quartz Reservoir and use of TUD's recycled water at the use areas.

Since 1994, the Facility has been regulated by Waste Discharge Requirements (WDRs) Order 94-192. WDRs Order 94-162 allows an ADWF of up to 2.6 mgd of secondary disinfected effluent into the TUD's reclamation system, which distributes secondary disinfected effluent from both Jamestown Utilities District's WWTF and the Sonora

Regional WWTF to use areas regulated by WDRs and Master Reclamation Permit Order R5-2002-0202 (Master Reclamation Permit).

This Order rescinds and replaces WDRs Order 94-192, and provides WDRs coverage for the Facility's discharge into the TUD reclamation system. The TUD reclamation system and recycled water distribution, storage, and use will continue to be covered under the Master Reclamation Permit until the Discharger applies for and obtains replacement coverage under State Water Resources Control Board Order WQ 2016-0068-DDW *Water Reclamation Requirements for Recycled Water Use* (Reclamation General Order). This Order requires the Discharger to apply for coverage under the Reclamation General Order.

MODIFICATIONS TO THE SONORA REGIONAL WWTF

The Sonora Regional WWTF has been upgraded to treat an annual ADWF of 2.0 mgd, with a peak day capacity of 5.0 mgd, though additional storage is available to handle peak wet weather flows. The wastewater treatment system consists of two extended aeration activated sludge basins, two secondary clarifiers, two woven polyester media disk filters, and two chlorine contact basins with sodium hypochlorite metering pumps and sodium hypochlorite storage tanks. The extended aeration activated sludge basins are lined with 45-mil geotextile fabric liners and have an underdrain leak detection system. The final effluent produced by the Sonora Regional WWTF meets the requirements of California Code of Regulations, title 22, for disinfected tertiary recycled water. Secondary treatment at the Facility is provided by utilizing both aerobic and anoxic conditions within the secondary treatment basins. Nitrification and denitrification is provided within the basins. Tertiary and disinfection treatment consists of four sections of a custom cast-in-place treatment system that features: a pre-filter channel, two Veolia Hydrotech™ Disk Filters, a post-filter channel, and two chlorine contact basins. Two chlorine contact basins provide a minimum of 90 minutes of modal contact time at a total flow rate of 2.5 mgd (1.25 mgd per basin) using a sodium hypochlorite solution that will be injected into the basins at minimum water level.

Previously unlined emergency storage pond A was lined with a 45-mil reinforced polypropylene liner to act as the new emergency storage basin. The emergency storage basin at the Facility will provide 2.8 million gallons of emergency storage during extreme wet weather conditions or during emergency shutdown/failure. The reclaimed water distribution system consists of the main storage reservoir (Quartz Reservoir), nine miles of pipeline, and approximately 630 acres of use areas (855 acres when the connection to the Teleli Golf Course is completed) across 26 end users. According to the Title 22 Engineering Report, 108.3 acres of irrigable area owned by reclaimed water users upgradient of Quartz Reservoir can be supplied directly.

2023 ANTIDegradation ANALYSIS REPORT

On 30 August 2023, Central Valley Water Board staff received a report titled *Antidegradation and Background Groundwater Analysis Report for the Tuolumne Utilities District Quartz Reservoir and Land Application Areas* (Antidegradation Analysis), submitted on behalf of the TUD by RBI. The Antidegradation Analysis utilized an intrawell approach using individual well data to assess the distribution of the data and calculated statistical concentration limits. For each constituent of concern, a background threshold value was generated following the Unified Guidance Approach.⁸ In addition, it was determined that an interwell analysis was infeasible at the Quartz Reservoir, Rosasco Use Area, and Gardella Use Area due to spatial variability between upgradient/downgradient wells, variability in the data, and trended data in some wells.

The Antidegradation Analysis Report concluded that detected exceedances of groundwater protection standards/background threshold values were not due to Facility operations and discharges, but to other sources such as local farming and cattle grazing practices. The upgraded Facility will produce recycled water compliant with Title 22's tertiary disinfected recycled water standard, which is the highest water quality required by Title 22 for unrestricted recycled water land application in California.

GROUNDWATER CONSIDERATIONS

Groundwater conditions are discussed in Findings 59 to 67 of the Order. While not specific to these WDRs, groundwater monitoring required under the Master Reclamation Permit includes three groundwater monitoring well networks consisting of a total of 21 monitoring wells around the Quartz Reservoir, Rosasco Use Area, and Gardella Use Area. The depth to water in the monitoring wells typically ranges from about five feet below top of casing to sixty feet below top of casing. Water elevation maps submitted and prepared by Condor Earth as part of quarterly groundwater monitoring reports generally indicate groundwater flows both north and south near the divide at Quartz Reservoir (see Figure 1 below).

⁸ See U.S. EPA's Statistical Analysis of Groundwater Monitoring Data at RCRA Facilities, Unified Guidance (2009).

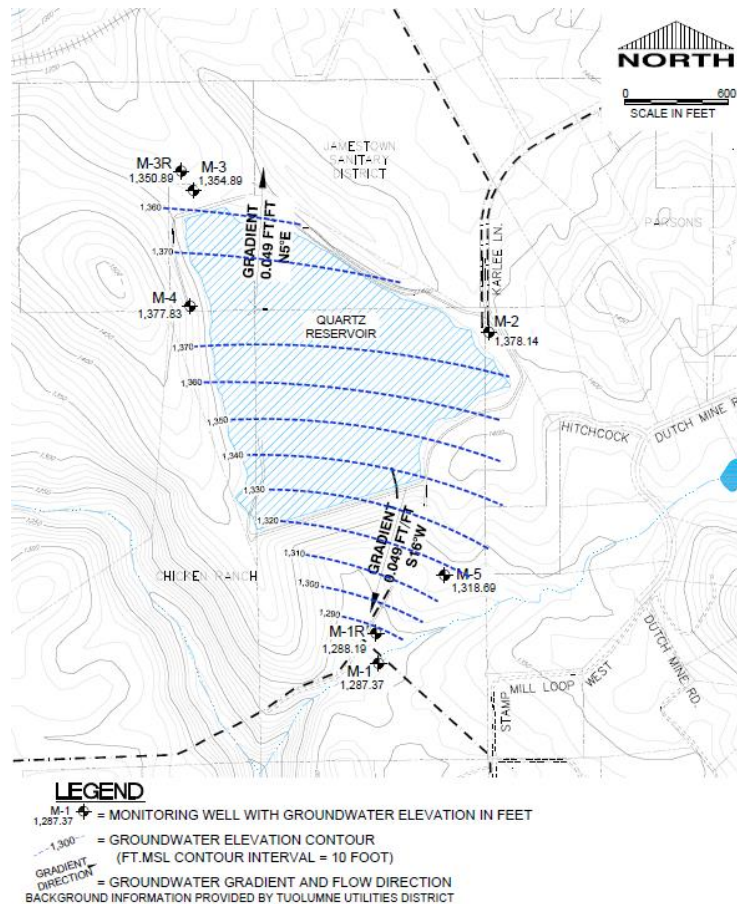

Figure 1 – Groundwater Elevation Contours – Taken From *Quarterly Groundwater Monitoring Report April 1, 2022 Through June 30, 2022.*

Figure 2 below shows the groundwater trends in the Quartz Reservoir groundwater monitoring wells over the past few years for total dissolved solids (TDS). Figure 2 shows slightly increasing values for upgradient/cross-gradient wells M-2 and M-4. However, TDS values for the downgradient wells appear to be trending upward according to the figure. At the downgradient wells, the increases are not likely due to TDS in the WWTF effluent, considering the average effluent TDS is 305 mg/L.

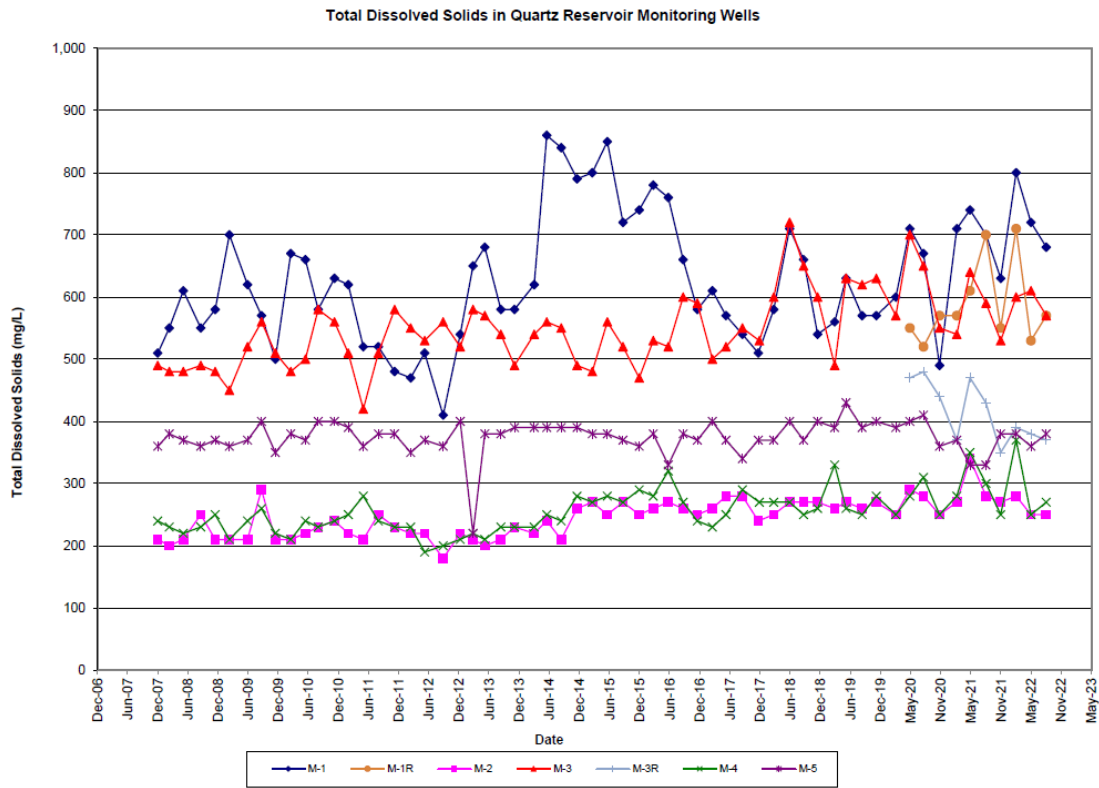

Figure 2 – Groundwater TDS Trends

Figure 3 below shows groundwater trends for nitrate in Quartz Reservoir groundwater monitoring wells. Most of the values are below the maximum contaminant level (MCL) of drinking water of 10 mg/L. Nitrate concentrations appear to be trending down. Non-detect (ND) values reported in the groundwater monitoring reports were shown as “zero” for simplicity. Wells with elevated nitrate (M-1 and M-1R) contain groundwater originating from a source with TDS much higher than contained in recycled water stored in Quartz Reservoir. This indicates that nitrate observed in these wells is not likely due to using Quartz Reservoir to store TUD’s recycled water. Historically, nitrate in WWTF effluent and Quartz Reservoir has averaged 2 mg/L. Low nitrate levels and total nitrogen levels in the discharge will continue since the upgraded WWTF removes nitrogen and nitrate by fully nitrifying and denitrifying its wastewater in the new aeration basins.

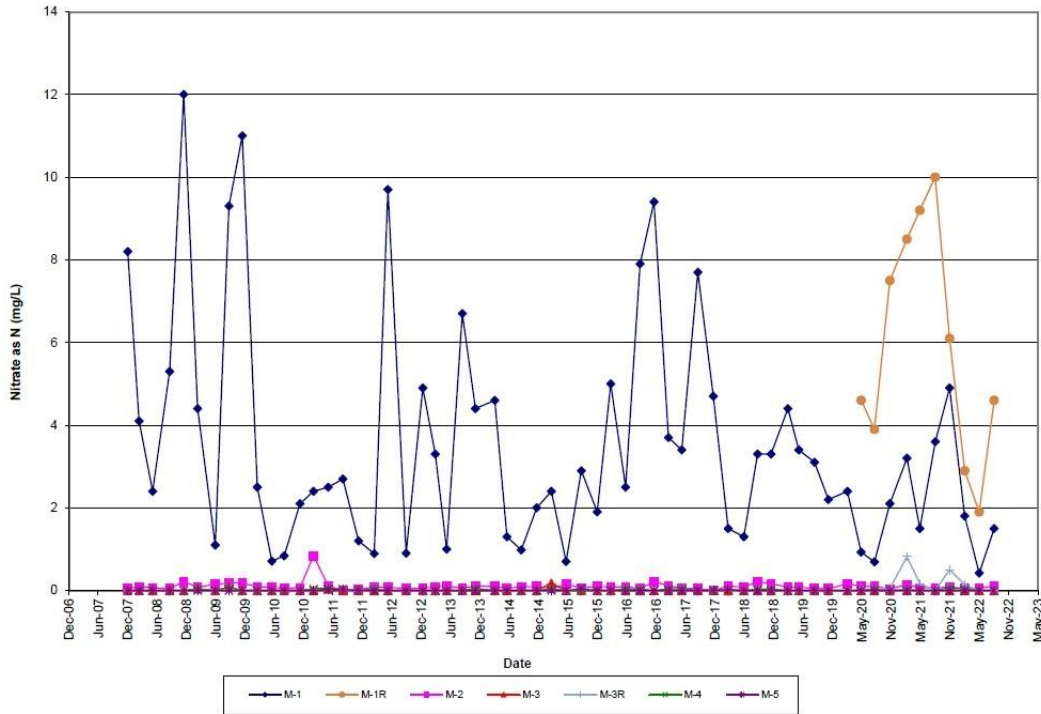

Figure 3 – Groundwater Nitrate as Nitrogen Trends

WASTEWATER RECLAMATION

The Discharger operates a reclaimed water distribution system, consisting of pumping facilities, distribution pipelines, Quartz Reservoir (main storage area), and smaller storage ponds. TUD’s effluent from the Sonora Regional WWTF is conveyed to the Quartz Reservoir by a gravity flow line. Prior to delivery to Quartz Reservoir, a limited number of end users can be supplied via turnouts along the line. Effluent from Jamestown Sanitary District’s WWTF is discharged by gravity to Quartz Reservoir. Reclaimed water is delivered to use areas through eighteen turnouts along nine miles of six-to-twenty-four-inch transmission and distribution lines. Reclaimed water is used mainly for the spray or flood irrigation of fodder crops and pasture for animals not producing milk for human consumption.

DISCHARGE PROHIBITIONS, LIMITATIONS, SPECIFICATIONS, AND PROVISIONS

This Order specifies the following effluent flow limitations: a 1.84 mgd monthly ADWF limit, a 2.0 mgd monthly ADWF limit upon Central Valley Water Board’s approval of Provision I.5, and maximum daily flow limit of 5.0 mgd. The Order specifies tertiary-treated effluent limits of 10 mg/L (monthly average) and 20 mg/L (daily max) for both biochemical oxygen demand (BOD) and total suspended solids (TSS). For salinity, this Order sets an effluent Salinity Action Level of 800 µmhos/cm for EC. Furthermore, the

Order specifies an annual average limit of 10 mg/L for total nitrogen and total coliform limitations for disinfected tertiary treated effluent (2.2 MPN/100 ml seven-day median, 23 MPN/100 ml more than once in any 30-day period, and 240 MPN/100 ml maximum). This Order also prescribes groundwater limitations that ensure the discharge does not affect present and anticipated beneficial use of groundwater.

This Order requires the Discharger to submit a Notice of Intent to apply for coverage under the Reclamation General Order. Also, this Order includes a provision requiring the Discharger to certify the additional use area (Teleli Golf Course) can reclaim recycled water and that there is sufficient storage and disposal capacity for an ADWF of 2.0 mgd. In addition, this Order includes provisions requiring various technical reports/work plans. These reports/plans include a Liner Operation Maintenance and Monitoring Reporting Plan.

MONITORING REQUIREMENTS

Water Code section 13267 authorizes the Central Valley Water Board to require monitoring and technical reports as necessary to investigate the impacts of waste discharges on waters of the State. Water Code section 13268 authorizes assessment of criminal, civil, and/or administrative civil liability where parties fail to comply with orders issued pursuant to section 13267. This Order includes influent, effluent, solids, groundwater, and water supply monitoring requirements. This monitoring is necessary to characterize the discharge and evaluate compliance with the requirements and specifications of the Order.

SALT AND NITRATE CONTROL PROGRAMS REGULATORY CONSIDERATIONS

As part of the Central Valley Salinity Alternatives for Long-Term Sustainability (CV-SALTS) initiative, the Central Valley Water Board adopted Basin Plan amendments (Resolution R5-2018-0034), as revised in 2020 (Resolution R5-2020-0057), incorporating new programs for addressing ongoing salt and nitrate accumulation in the Central Valley.
(https://www.waterboards.ca.gov/centralvalley/board_decisions/adopted_orders/resolutions/r5-2020-0057_res.pdf).

For the Salt Control Program, a Notice to Comply was issued to the Discharger (CV-SALTS ID 2511) on 5 January 2021. On 28 June 2021, the Discharger submitted the required fee payment to comply with the Salt Control Program by joining the P&O Study.

For the Nitrate Control Program, the Facility falls outside of a groundwater basin, so it is not currently subject to this Program. A Notice to Comply may be issued if the Central Valley Water Board Executive Officer determines it is necessary to protect water quality.

The CV-SALTS initiative will result in regulatory changes that will be implemented through conditional discharge prohibitions and modifications to many WDRs regionwide,

including the WDRs that regulate discharges from the Facility. More [information regarding the CV-SALTS regulatory planning process](https://www.waterboards.ca.gov/centralvalley/water_issues/salinity/) can be found at the following link: (https://www.waterboards.ca.gov/centralvalley/water_issues/salinity/).

REOPENER

The conditions of discharge in the Order were developed based on currently available technical information and applicable water quality laws, regulations, policies, and plans, and are intended to assure conformance with them. The Order sets limitations based on the information provided thus far. If applicable laws and regulations change, or once new information is obtained that will change the overall discharge and its potential to impact groundwater, it may be appropriate to reopen the Order.

LEGAL EFFECT OF RESCISSION OF PRIOR WDRS OR ORDERS ON EXISTING VIOLATIONS

The Central Valley Water Board's rescission of prior waste discharge requirements and/or monitoring and reporting orders does not extinguish any violations that may have occurred during the time those waste discharge requirements or orders were in effect. The Central Valley Water Board reserves the right to take enforcement actions to address violations of prior prohibitions, limitations, specifications, requirements, or provisions of rescinded waste discharge requirements or orders as allowed by law.